

GATES INDUSTRIAL POWER TRANSMISSION

CATALOG NO. 20211

EDITION 2024

SUPERSEDES 20211 (2023)

A COMPREHENSIVE PRODUCT RANGE

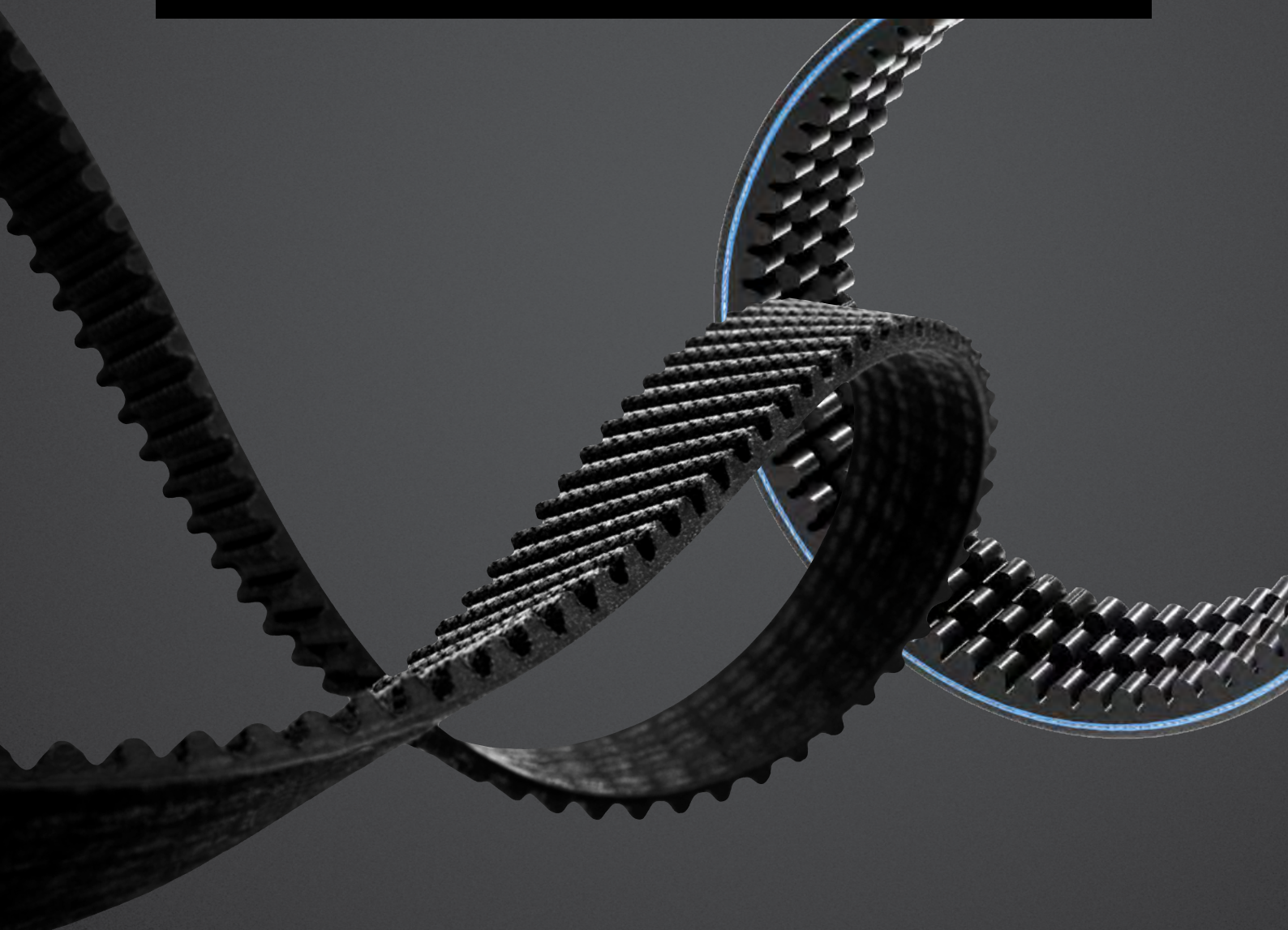

DRIVEN BY POSSIBILITY™



OUR VISION

**“CONTINUALLY PUSH THE
BOUNDARIES OF
MATERIALS SCIENCE TO
ADVANCE THE WAY THE
WORLD MOVES.”**



GATES. DRIVEN BY POSSIBILITY.

If it runs, we can help it run better. Gates is a global leader in power transmission and fluid power products and services. We serve customers across industries, bringing relentless innovation, and uncompromising quality to every product we make. Our reputation is built on over a century of experience, but everything we do is geared towards powering the future.

POWER TRANSMISSION DIVISION

In 1917, John Gates revolutionized industrial machinery with the world's first rubber V-Belt, and began the legacy of advanced design that defines The Gates Corporation. In 1946, Gates invented the first toothed timing belt, known as the synchronous belt. In 1979, we created the multi-ribbed belt that changed automotive transmission as we know it. Continuous innovation isn't just what we do. It's who we are.

Trust the leaders in research, design, material science, and the manufacturing of the best power transmission solutions in the world - only with Gates.

ENGINEERED TO EXCEED EXPECTATIONS.

The Gates brand is a promise. A promise that all of our products have been manufactured to the highest possible standards. In nearly every corner of industry and nearly every working environment imaginable, when a part has to do the job it was designed for, it has to be Gates.

WHERE OTHERS SEE THE UNKNOWN, WE SEE POSSIBILITY.

Change is a part of the Gates DNA. We never stand still, but are always looking for ways to meet emerging challenges head-on with solutions that accelerate our partners' growth and development.

COMMITTED TO YOUR BUSINESS.

In every engagement, we work tirelessly to listen to our partners and to develop solutions for their challenges that change their business for the better. Our greatest achievement is their success.

INDEX

1. V-BELTS	5
01 · PREDATOR™	6
02 · QUAD-POWER™ 4	7
03 · SUPER HC™	8
04 · HI-POWER™	9
05 · SUPER HC™ MN	10
06 · TRI-POWER™	11
07 · DELTA™ RANGE	12
08 · PREDATOR POWERBAND™	14
09 · QUAD-POWER™ 4 POWERBAND™	15
10 · SUPER HC™ & HI-POWER POWERBAND™	16
11 · HI-POWER DUBL-V™	17
12 · MULTI-SPEED™	18
13 · POWERATED™	19
14 · POLYFLEX™	20
15 · POLYFLEX JB™	21
16 · MICRO-V®	22
2. SYNCHRONOUS BELTS	23
17 · POLY CHAIN® CARBON™ VOLT™	25
18 · MINI POLY CHAIN GT™ CARBON 8MGT	26
19 · POLY CHAIN GT CARBON 5MGT	27
20 · POLY CHAIN GT CARBON EXTENDED LENGTH	28
21 · POLY CHAIN GT2™	29
22 · POWERGRIP™ GTX™	30
23 · POWERGRIP GT3 2MGT, 3MGT & 5MGT	31
24 · POWERGRIP GT4 8MGT & 14MGT	32
25 · POWERGRIP HTD™ 3M & 5M	33
26 · POWERGRIP HTD 8M, 14M & 20M	34
27 · POWERGRIP	35
28 · TWIN POWER™	36
29 · LONG LENGTH	38
30 · POWERPAINT™	40
3. POLYURETHANE BELTS	41
31 · SYNCHRO-POWER™ SLEEVE	42
32 · CUSTOMISED POLYURETHANE BELTS	43
33 · SYNCHRO-POWER FLEX™	44
34 · SYNCHRO-POWER LINEAR	45
35 · SYNCHRO-POWER WIDE	46
36 · SYNCHRO-POWER FLAT	47
4. METAL PARTS	48
37 · SPROCKETS POLY CHAIN GT 8MGT - 14MGT	49
38 · SPROCKETS POLY CHAIN 5MGT/POWERGRIP 5MGT	50
39 · SPROCKETS POLY CHAIN GT STAINLESS STEEL 8MGT	51
40 · IDLER SPROCKETS POLY CHAIN GT 8MGT & 14MGT	52
41 · IDLER BRACKETS	53
42 · FLAT IDLER SPROCKETS	54
5. PREVENTIVE MAINTENANCE TOOLS	55
43 · V-BELT SPROCKET GAUGES	56
44 · INDUSTRIAL BELT LENGTH FINDER	57
45 · SINGLE / DOUBLE BARREL TENSION TESTER	58
46 · SONIC TENSION METER 550C	59
47 · SONIC TENSION METER 350C	60
48 · LASER AT-1	61
49 · BELT INSTALLATION AND ROTATION DEVICE	62



6. V-BELTS SIZE LIST	63	7. SYNCHRONOUS BELTS SIZE LIST	154
01 · PREDATOR SPBP/5VP	64	POLY CHAIN CARBON VOLT BELTS - 8MGT AND 14MGT	155
02 · PREDATOR SPCP	65	POLY CHAIN GT CARBON BELTS - 8M SHORT LENGTH	160
03 · PREDATOR 8VP	66	POLY CHAIN GT CARBON BELTS - 5MGT	161
04 · QUAD-POWER 4 XPZ-3VX	66	POLY CHAIN GT CARBON - EXTENDED LENGTH™ BELTS	162
05 · QUAD-POWER 4 XPA	69	POLY CHAIN GT2 BELTS - 8MGT AND 14MGT	163
06 · QUAD-POWER 4 XPB-5VX	72	POWERGRIP GTX BELTS AND SLABS - 8MX AND 14MX	168
07 · QUAD-POWER XPC	74	POWERGRIP GT4 BELTS AND SLABS - 8MGT AND 14MGT	179
08 · SUPER HC SINGLE - SPZ-3V	74	POWERGRIP GT3 BELTS AND SLABS - 2MGT, 3MGT AND 5MGT ...	185
09 · SUPER HC SINGLE - SPA	77	POWERGRIP HTD BELTS AND SLABS - 3M, 5M, 8M, 14M	
10 · SUPER HC SINGLE - SPB-5V	80	AND BELTS 20M	196
11 · SUPER HC SINGLE - SPC	82	POWERGRIP TIMING BELTS AND SLABS - MXL, XL, L, H, XH, XXH ...	216
12 · SUPER HC SINGLE - 8V	83	POWERPAINT POWERGRIP SLABS - 8M AND 14M	240
13 · SUPER HC MN XPZ	84	TWIN POWER POWERGRIP GT2 BELTS AND SLABS - 8MGT	
14 · SUPER HC MN XPA	85	AND BELTS 14MGT	244
15 · SUPER HC MN XPB	87	TWIN POWER POWERGRIP HTD BELTS AND SLABS - 5M	248
16 · TRI-POWER - AX	88	TWIN POWER POWERGRIP XL, L, H TIMING BELTS AND SLABS ...	250
17 · TRI-POWER - BX	89	LONG LENGTH POLY CHAIN GT CARBON AND	
18 · TRI-POWER - CX	90	POWERGRIP BELTING	256
19 · HI-POWER - Z	91	SPROCKETS POLY CHAIN GT 8MGT - 14MGT	258
20 · HI-POWER - A	93	SPROCKET INFORMATION	259
21 · HI-POWER - B	96	SPROCKETS POLY CHAIN 5MGT/POWERGRIP 5MGT	264
22 · HI-POWER - C	99	SPROCKETS POLY CHAIN GT STAINLESS STEEL 8MGT	266
23 · HI-POWER - D	102	IDLER SPROCKETS POLY CHAIN GT 8MGT & 14MGT	267
24 · HI-POWER - E	103	IDLER BRACKET	268
25 · DELTA CLASSIC - Z	103	FLAT IDLER SPROCKET	269
26 · DELTA CLASSIC - A	104	SYNCHRO-POWER T2.5-4 BELT	270
27 · DELTA CLASSIC - B	107	SYNCHRO-POWER T2.5-6 BELT	270
28 · DELTA CLASSIC - C	110	SYNCHRO-POWER T2.5-8 BELT	271
29 · DELTA CLASSIC - D	113	SYNCHRO-POWER T2.5-10 BELT	271
30 · DELTA NARROW - SPZ	114	SYNCHRO-POWER T2.5-12 BELT	272
31 · DELTA NARROW - SPA	117	SYNCHRO-POWER T2.5-16 BELT	272
32 · DELTA NARROW - SPB	120	SYNCHRO-POWER T2.5-20 BELT	273
33 · DELTA NARROW - SPC	121	SYNCHRO-POWER T2.5-25 BELT	273
34 · PREDATOR PB 5VP-15JP	124	SYNCHRO-POWER T2.5-32 BELT	274
35 · PREDATOR PB SPBP	126	SYNCHRO-POWER T2.5-50 BELT	274
36 · PREDATOR PB SPCP	128	SYNCHRO-POWER T2.5-SLEEVE	275
37 · PREDATOR PB 8VP	130	SYNCHRO-POWER T5-4 BELT	276
38 · QUAD-POWER 4 POWERBAND - XPZ	132	SYNCHRO-POWER T5-6 BELT	277
39 · QUAD-POWER 4 POWERBAND - XPA	133	SYNCHRO-POWER T5-8 BELT	278
40 · QUAD-POWER 4 POWERBAND - XPB	134	SYNCHRO-POWER T5-10 BELT	279
41 · SUPER HC MN POWERBAND - 3VX, 5VX - ONLINE	135	SYNCHRO-POWER T5-12 BELT	280
42 · SUPER HC POWERBAND - SPB	136	SYNCHRO-POWER T5-16 BELT	281
43 · SUPER HC POWERBAND - SPC	138	SYNCHRO-POWER T5-20 BELT	282
44 · SUPER HC POWERBAND - 3V-9J	140	SYNCHRO-POWER T5-25 BELT	283
45 · SUPER HC POWERBAND 5V-15J	142	SYNCHRO-POWER T5-32 BELT	284
46 · SUPER HC POWERBAND 8V	144	SYNCHRO-POWER T5-50 BELT	285
47 · HI-POWER POWERBAND	146	SYNCHRO-POWER T5-75 BELT	286
48 · HI-POWER DUBL-V	146	SYNCHRO-POWER T5-SLEEVE	287
49 · MULTI-SPEED	146	SYNCHRO-POWER T10-10 BELT	289
50 · POWERATED	147	SYNCHRO-POWER T10-12 BELT	290
51 · POLYFLEX	147	SYNCHRO-POWER T10-16 BELT	291
52 · POLYFLEX JB	147	SYNCHRO-POWER T10-20 BELT	292
53 · MICRO-V - PJ	148	SYNCHRO-POWER T10-25 BELT	293
54 · MICRO-V - PK	150	SYNCHRO-POWER T10-32 BELT	294
55 · MICRO-V - PL	151	SYNCHRO-POWER T10-50 BELT	295
56 · MICRO-V - PM	152	SYNCHRO-POWER T10-75 BELT	296
		SYNCHRO-POWER T10-SLEEVE	297



SYNCHRO-POWER AT5-4 BELT	299
SYNCHRO-POWER AT5-6 BELT	299
SYNCHRO-POWER AT5-8 BELT	300
SYNCHRO-POWER AT5-10 BELT	300
SYNCHRO-POWER AT5-12 BELT	301
SYNCHRO-POWER AT5-16 BELT	301
SYNCHRO-POWER AT5-20 BELT	302
SYNCHRO-POWER AT5-25 BELT	302
SYNCHRO-POWER AT5-32 BELT	303
SYNCHRO-POWER AT5-50 BELT	303
SYNCHRO-POWER AT5-75 BELT	304
SYNCHRO-POWER AT5-SLEEVE	305
SYNCHRO-POWER AT10-10 BELT	306
SYNCHRO-POWER AT10-12 BELT	306
SYNCHRO-POWER AT10-16 BELT	307
SYNCHRO-POWER AT10-20 BELT	307
SYNCHRO-POWER AT10-25 BELT	308
SYNCHRO-POWER AT10-32 BELT	308
SYNCHRO-POWER AT10-50 BELT	309
SYNCHRO-POWER AT10-75 BELT	309
SYNCHRO-POWER AT10-SLEEVE	310
SYNCHRO-POWER DL-T5-6 BELT	311
SYNCHRO-POWER DL-T5-8 BELT	311
SYNCHRO-POWER DL-T5-10 BELT	311
SYNCHRO-POWER DL-T5-12 BELT	311
SYNCHRO-POWER DL-T5-16 BELT	312
SYNCHRO-POWER DL-T5-20 BELT	312
SYNCHRO-POWER DL-T5-25 BELT	312
SYNCHRO-POWER DL-T5-32 BELT	312
SYNCHRO-POWER DL-T5-50 BELT	313
SYNCHRO-POWER DL-T5-75 BELT	313
SYNCHRO-POWER DL-T5-SLEEVE	313
SYNCHRO-POWER DL-T10-10 BELT	314
SYNCHRO-POWER DL-T10-12 BELT	314
SYNCHRO-POWER DL-T10-16 BELT	314
SYNCHRO-POWER DL-T10-20 BELT	314
SYNCHRO-POWER DL-T10-25 BELT	315
SYNCHRO-POWER DL-T10-32 BELT	315
SYNCHRO-POWER DL-T10-50 BELT	315
SYNCHRO-POWER DL-T10-SLEEVE	316
SYNCHRO-POWER LINEAR T PITCHES	317
SYNCHRO-POWER LINEAR AT PITCHES	318
SYNCHRO-POWER LINEAR ATL PITCHES	319
SYNCHRO-POWER LINEAR HTD PITCHES	320
SYNCHRO-POWER LINEAR GPP PITCHES	321
SYNCHRO-POWER LINEAR STD PITCHES	322
SYNCHRO-POWER LINEAR IMPERIAL PITCHES	323
8. SUPPORT SERVICES	324
GATES. DRIVEN BY POSSIBILITY	325
DESIGN POWER™: GATES DRIVE DESIGN SOFTWARE	325
GATES COST SAVING PROGRAMME	326
GATES E-COMMERCE WEBSITE	326
GATES LITERATURE AND WEBSITE	326
GATES MANUFACTURING AND DISTRIBUTION IN EUROPE	326
NOTES	327



1. V-BELTS



01 PREDATOR

HEAVY DUTY WRAPPED, NARROW SECTION V-BELT WITH ARAMID CORD

Gates Predator V-belts are the markets leading heavy duty V-belts. Unique in their extreme robustness and high load carrying capability they are unrivalled. They are excellent problem solvers that perform well in harsh environments and in extremely demanding applications where standard V-belts have performance issues. The Predator belt difference is in the construction: they have the highest power density of any V-belt and virtually zero stretch because of the use of high strength, high modulus aramid tensile cords.

CONSTRUCTION

- Aramid tensile cords provide extraordinary strength, durability and virtually zero stretch.
- Double fabric cover offers extreme abrasion and wear resistance.
- Specially treated extra tough cover withstands slip and shear forces at peak loads without generating excessive heat and resists penetration by foreign materials.
- Improved rubber compounds provide superbe oil and heat resistance.
- Non-rubber Bare back surfaced cover allows momentary slippage due to excessive overloads without damaging the belt.

BENEFITS

- At least 40% higher power ratings than standard construction V-belts.
- No need for constant belt re-tensioning: less maintenance, less downtime.
- Excellent problem solver.
- Static conductive (ISO 1813 - with the exception of 8VP) and can as such be used in the conditions described in the Directive 2014/34/EU- ATEX.
- **Available on demand in Matched sets. Contact Customer Service for details.**
- REACH and RoHS 2 compliant.
- Temperature range: -30 °C to +60 °C.



ORDERING CODE

SPBP3350
SPB - Section
P - Predator version
3350 - Datum length (mm)
NOTE: For correct design and tensioning of the belt please use Gates Design Power software, available on www.gates.com

PLEASE REFER TO P. 64 FOR SIZE LIST.

SECTIONS AND NOMINAL DIMENSIONS

Section	Width (mm)	Height (mm)	Length range (datum length - mm)
SPBP/5VP	16	13	1500 - 8000
SPCP	22	18	2000 - 10600
8VP	26	23	4064 - 9017

SPBP/5VP SPCP 8VP

PREDATOR SPBP & SPCP also available in PowerBand version p. 14.

02 QUAD-POWER 4

HEAVY DUTY RAW EDGE, MOULDED NOTCH, NARROW SECTION V-BELT

By using innovative minimal-stretch cord technology, Gates Quad-Power 4 bandless V-belts are free of maintenance. Unlike conventional belts, the Quad-Power 4 V-belt does not suffer from severe tension decay in the first hours after installation. So no run-in period nor any re-tensioning are required. These SERVICE FREE EPDM belts are designed to extend product life time eliminating costly downtime for re-tensioning, repair and replacement.

CONSTRUCTION

- Minimal-elongation polyester tensile cords allow for stable tension over the entire lifetime.
- Blue adhesion layer for an extra strong bonding of the tensile cords and the rubber compound.
- Optimized notch form for reduced bending stress and improved efficiency.
- New generation EPDM rubber compound to ensure a long service life and a wear-resistant belt under extreme temperatures.

ORDERING CODE

XPZ600

XPZ - Section

600 - Datum length (mm)

3VX238

3VX - Section

238 - Effective length (inch 23.8)

NOTE: For correct design and tensioning of the belt please use Gates Design Power software, available on www.gates.com

PLEASE REFER TO P. 66 FOR SIZE LIST.

BENEFITS

- Energy efficiencies up to 98%.
- Less downtime.
- Fewer replacements.
- Higher performance.
- Wider temperature range.
- Halogen-free belt.
- A clear branding for ease of identification.
- Perfect fit on standard ISO/DIN V-sprockets and 3VX/5VX for RMA sprocket grooves.
- REACH and RoHS 2 compliant.
- Static conductive (ISO 1813) and can as such be used in the conditions described in the Directive 2014/34/EU- ATEX.
- **Match** system: all sizes meet Gates **UNISET** tolerances, they can be installed without matching.
- Temperature range: -50 °C to +130 °C.

SECTIONS AND NOMINAL DIMENSIONS

Section	Width (mm)	Height (mm)	Length range (datum length - mm)
XPZ/3VX	10	8	600 - 3550
XPA	13	10	690 - 4000
XPB/5VX	16	13	1000 - 5070
XPC	22	18	1900 - 5000

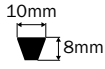
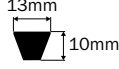
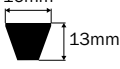
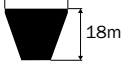
 <p>10mm 8mm XPZ/3VX</p>	 <p>13mm 10mm XPA</p>	 <p>16mm 13mm XPB/5VX</p>	 <p>22mm 18mm XPC</p>
--	---	---	---

Quad-Power 4 XPZ, XPA & XPB also available in PowerBand version p. 15.



03 SUPER HC

WRAPPED, NARROW SECTION V-BELT

The Gates Super HC V-belt combines the strength of a wrapped belt construction with the economies of a narrow section V-belt. It transmits more power in a given space and allows more compact drive design than classical section V-belts. In short, it offers you more power and considerably reduces the space needed. This significantly cuts the overall drive cost. Super HC V-belts also have exclusive Gates construction features for longer life on your drives!

CONSTRUCTION

- Arched top, concave sidewalls and rounded corners provide uniform tensile loading and uniform sprocket sidewall contact for excellent belt service and reduced sprocket wear.
- The Flex-Weave oil and heat resistant cover protects the belt.
- The vulcanised Flex-bonded tensile cords provide superior resistance to tensile and flexing forces, fatigue and shock loads.
- The belt will not catch fire from heat buildup, even with severe slippage.
- Static conductive (ISO 1813) and can as such be used in the conditions described in the Directive 2014/34/EU- ATEX.

ORDERING CODE

SPZ 1060/3V420
SPZ - Section
1060 - Datum length (mm)
3V - Section
420 - Effective length (42.0 inch)
NOTE: For correct design and tensioning of the belt please use Gates Design Power software, available on www.gates.com

PLEASE REFER TO P. 136 FOR SIZE LIST

BENEFITS

- Excellent performance/cost ratio.
- More compact design compared to classical section V-belts.
- State of the art production process with rotocuring:
- Advanced smooth running characteristics
- Improved profile stability
- Results-driven change based on development expertise
- Cost and space savings by reducing size of sprockets, bearings, guards and mounts.
- Improved belt life reducing expensive maintenance time.
- **Match** system: all sizes meet Gates **UNISET** tolerances, they can be installed without matching.
- REACH and RoHS 2 compliant.
- Temperature range: -30°C to +60°C.

SECTIONS AND NOMINAL DIMENSIONS			
Section	Width (mm)	Height (mm)	Length range (datum length - mm)
SPZ/3V	10	8	487 - 3750
SPA	13	10	732 - 5000
SPB/5V	16	13	1250 - 8000
SPC	22	18	2000 - 16500
8V	26	23	2540 - 14225

SPZ/3V

SPA

SPB/5V

SPC

SPB, SPC also available in PowerBand version p. 16 or aramid cord construction p. 6.



04 HI-POWER

WRAPPED, CLASSICAL SECTION V-BELT

The wrapped classical section Hi-Power V-belt has a long reputation for reliability on agricultural and industrial applications. The arched top of the Hi-Power belt provides superior strength to prevent “dishing” and distortion of the tensile section. The cords are properly aligned, each of them carrying its full share of the load.

CONSTRUCTION

- Arched top, concave sidewalls and rounded corners provide uniform tensile loading and uniform sprocket sidewall contact for excellent belt service life and reduced sprocket wear.
- The Flex Weave oil and heat resistant cover protects the belt core from the toughest environments.
- The vulcanized Flex-bonded tensile cords provide superior resistance to tensile and flexing forces, fatigue and shock loads.
- High-quality rubber compound protects the belt against heat, ozone and sunlight.
- The belt will not catch fire from heat buildup, even with severe slippage.
- Static conductive (ISO 1813) and can as such be used in the conditions described in the Directive 2014/34/EU- ATEX.

ORDERING CODE

Z19

Z - Section

19 - Inside length (inch)

NOTE: For correct design and tensioning of the belt please use Gates Design Power software, available on www.gates.com

PLEASE REFER TO P. 146 FOR SIZE LIST - ONLINE

BENEFITS

- Excellent performance/cost ratio.
- Reliability and efficiency.
- Long belt life reducing replacement and maintenance costs.
- **Match** system: all sizes meet Gates **UNISET** tolerances, they can be installed without matching.
- REACH and RoHS 2 compliant.
- Temperature range: -30 °C to +60 °C.

SECTIONS AND NOMINAL DIMENSIONS

Section	Width (mm)	Height (mm)	Length range (datum length - mm)
Z	10	6	425 - 2500
A	13	8	457 - 5000
B	17	11	650 - 11960
C	22	14	1080 - 10795
D	32	19	2500 - 16850
E	38	25	4650 - 15330

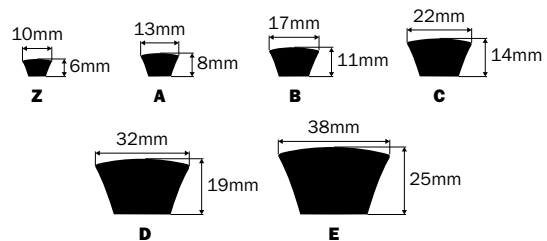

B, C & D sections also available in PowerBand version p. 16.



05 SUPER HC MN

RAW EDGE, MOULDED NOTCH NARROW SECTION V-BELT

Super HC MN V-belts put more power where high speeds, high speed ratios or small pulley diameters are required, offering significant benefits over classical section V-belts. Super HC MN belts are made of high-performance Ethylene Elastomer (EE) materials. The belt is highly recommended for use on all industrial heavy-duty, narrow section V-belt drives. With an increased transmission efficiency this belt allows for a more compact and highly economical drive design.

CONSTRUCTION

- MN = Moulded Notches reduce and evenly distribute thermal and bending stresses. The moulded notch pattern also reduces noise.
- Precision-ground straight sidewalls give a uniform wedging action and ensure the belt fits correctly in the pulley grooves.
- Flex-bonded tensile cords are vulcanised as one solid unit making the belt highly resistant to tensile and flexing forces, fatigue and shock loads.
- Good resistance to occasional exposure to oil and chemicals.
- Meets ARPM IP-3-3 and ISO 1813 static-conductivity standards.

BENEFITS

- Excellent performance/cost ratio.
- High performance, synthetic rubber compounds resist wear increasing belt life.
- Cost and space savings by reducing size of pulleys, bearings, guards and mounts.
- Belt edge machined for even sheave groove contact, resulting in smoother running, less slip and wear.
- **Match** system: all sizes meet Gates **UNISSET** tolerances, they can be installed without matching.
- REACH and RoHS 2 compliant.
- Temperature range: -51 °C to +121 °C.



ORDERING CODE

XPZ800
XPZ - Section
800 - Datum length (mm)
MN - Moulded notch
NOTE: For correct design and tensioning of the belt please use Gates Design Power software, available on www.gates.com

PLEASE REFER TO P. 84 FOR SIZE LIST.

SECTIONS AND NOMINAL DIMENSIONS

Section	Width (mm)	Height (mm)	Length range (datum length - mm)
XPZ/3VX	10	8	575-3550
XPA	13	10	690-4000
XPB/5VX	16	13	1000-5070

XPZ/3VX

XPA

XPB/5VX

06 TRI-POWER

HEAVY DUTY, RAW EDGE, MOULDED NOTCH, CLASSICAL SECTION

Gates Tri-Power V-belt is built for superior performance on heavy duty drives of classical crosssection. The raw edge construction and special notch design makes the Tri-Power belt especially suited for drives requiring small diameter sprockets and back idlers. The ethylene EPDM compound allows the belt to handle extreme temperatures up to +120 °C.

CONSTRUCTION

- This is a classical section/profile construction.
- Static conductive to ISO and RMA standards for use in explosive environments.
- Flex Bonded tensile cords for resistance to bending stress and separation.
- Cross oriented fiber loaded rubber compound for flexibility and stability.
- Meets ARPM IP-3-3 and ISO 1813 static-conductivity standards.
- EPDM rubber compound to ensure a long service life and a wear-resistant belt under extreme temperatures.

BENEFITS

- Notched construction to allow bending around small sprocket diameters.
- **Match** system: all sizes meet Gates **UNISSET** tolerances, they can be installed without matching.
- Raw edge, molded notch construction saves up to 3% on energy costs over wrapped belts.
- Improved flexibility for increased performance on small sprocket diameters.
- REACH and RoHS 2 compliant.
- Temperature range: -50 °C to +120 °C.

ORDERING CODE

AX39 13x1030

AX - Section

39 - Inside length (inch)

13 x 1030 - Width (mm) x Datum Length ISO (mm)

NOTE: For correct design and tensioning of the belt please use Gates Design Power software, available on www.gates.com

PLEASE REFER TO P. 86 FOR SIZE LIST.

SECTIONS AND NOMINAL DIMENSIONS

Section	Width (mm)	Height (mm)	Length range (datum length - mm)
AX	13	8	580 - 4445
BX	17	11	900-5070
CX *	22	14	1300-5300

*CX section is from US

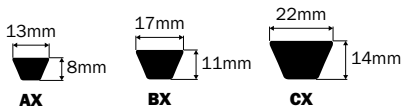



07 DELTA RANGE

With Gates you are fully equipped to run strong, whatever you need. Besides our wide range of premium belts, we now also offer you Gates Delta standard V-belts. These standard V-belts stand for a sharp price and performance in combination with trusted Gates quality. They provide the cost-effective solution for all your standard industry drives. Gates Delta belts are made to run.

CONSTRUCTION

- Quality rubber belt body.
- High-strength polyester tensile cords providing resistance to flexing forces, fatigue and shock loads.
- Oil-resistant flip band offering good grip and protection against abrasion.
- Good belt flexibility, stability and smooth running operation guaranteed.
- Static conductive (ISO 1813) and can as such be used in the conditions described in the Directive 2014/34/EU- ATEX.

BENEFITS

- **Match** system: all sizes meet Gates **UNISSET** tolerances, they can be installed without matching.
- Two V-belt profiles in a complete size range with excellent price/performance ratio.
- Made in Europe. Trusted quality, 100% made in our own Gates European factories.
- Made to run in all your standard industry drives.
- REACH and RoHS 2 compliant.
- Available in all popular sections and belt lengths.
- Specified to operate in a temperature range from -30 °C to +70 °C.





07 DELTA RANGE

DELTA CLASSIC™

Delta Classic V-belts have a classical V-shaped profile and are built for a reliable and durable performance on all industry standard classical section drives used in compressors, pumps, aggregates, alternators, saw, milling, and processing machines. Just to name a few.

ORDERING CODE
C62DELTA C - Section 62 - Inside length (inch) DELTA - Product name
PLEASE REFER TO P. 112 FOR SIZE LIST.

SECTIONS AND NOMINAL DIMENSIONS			
Section	Width (mm)	Height (mm)	Length range (datum length - mm)
Z	10	6	400 - 1803
A	13	8	425 - 5000
B	17	11	660 - 7110
C	22	14	1092 - 8532
D	32	19	2000 - 15240
E	38	25	3748 - 13918

DELTA NARROW™

Delta Narrow V-belts have a narrow section profile, making them the perfect option for all industry standard drives commonly referred to as narrow or deep wedge.

ORDERING CODE
SPA732DELTA SPA - Section 732 - Datum length (mm) DELTA - Product name
PLEASE REFER TO P. 103 FOR SIZE LIST.

SECTIONS AND NOMINAL DIMENSIONS			
Section	Width (mm)	Height (mm)	Length range (datum length - mm)
SPZ	10	8	562 - 3550
SPA	13	10	732 - 4500
SPB	16	13	1250 - 8000
SPC	22	18	2000 - 11200



08 PREDATOR POWERBAND

HEAVY DUTY WRAPPED NARROW SECTION JOINED V-BELT WITH ARAMID CORD

Gates' Predator PowerBand belt design offers a solution for drives where single belts vibrate, turn over or jump off the sprockets. It consists of several V-belts joined together by a permanent, high-strength tie band allowing the belts to work together as one unit. The Predator Powerband belt is especially designed for demanding applications and harsh environments and offers a high resistance to vibration. Predator Powerband are available in SPBP, SPCP, 5VP/15JP and 8VP section.

CONSTRUCTION

- Narrow cross-sections.
- Strong tie band joins the back of all belts.
- Flex bonded aramid tensile cords.
- Double layer bare back fabric cover.
- Fibre-loaded compound for improved belt stability.
- Gates curves provide full contact with sprocket grooves for uniform loading of cords, uniform wear and increased belt life.
- The belt will not catch fire from heat build-up, even with severe slippage.

BENEFITS

- At least 40% higher power ratings than standard construction V-belts.
- No need for constant belt re-tensioning.
- Aramid tensile cords easily handle shock loads.
- Less maintenance, less downtime.
- Excellent problem solver.
- Feature a multiple layer tie band that provides excellent lateral rigidity to prevent belts from turning over or from coming off the drive.
- Predator PowerBand belts are static conductive (ISO 1813) (except for 8VP) and can as such be used in the conditions described in the Directive 2014/34/EU- ATEX.
- Available on demand in matched sets. Contact Customer Service for details.
- REACH and RoHS 2 compliant
- Temperature range: -30°C to +60°C.

ORDERING CODE
SPBP3350/3 SPB - Section P - Predator version 3350 - Datum length (mm) 3 - Number of ribs NOTE: For correct design and tensioning of the belt please use Gates Design Power software, available on www.gates.com
PLEASE REFER TO P. 124 FOR SIZE LIST.

SECTIONS AND NOMINAL DIMENSIONS

Section	Width (mm)	Height (mm)	Rib spacing/ Pitch (mm)	Available number of ribs	Length range (datum length - mm)
SPBP	16	13	19.0	2 · 16	2120 - 8000
SPCP	22	18	25.5	2 · 12	3000 - 11200
5VP/ 15JP	16	13	17.5	2 · 16	1400 - 9000 effective length - mm
8VP/ 25JP	26	23	28.6	2 · 12	5080 - 10200 effective length - mm

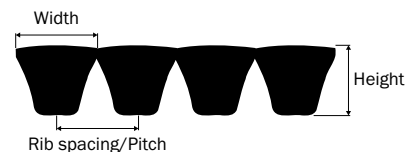



09 QUAD-POWER 4 POWERBAND

HEAVY DUTY RAW EDGE, MOULDED NOTCH, NARROW SECTION, JOINED V-BELT

Gates PowerBand belts are engineered for drives that are subject to pulsating loads, shock loads or extreme vibrations. By joining several Quad-Power 4 V-belts together the Quad-Power 4 PowerBand offers a maintenance-free solution for drives where single belts vibrate, turn over or jump off the sprockets. It comes with all of the advantages of the single belt: this SERVICE FREE EPDM belts are designed to extend product life time eliminating costly downtime for re-tensioning, repair and replacement. Furthermore these belts offer a broad temperature operating range.

CONSTRUCTION

- Minimal-elongation polyester tensile cords allow for stable tension over the entire lifetime.
- PowerBand construction is built as one solid unit, controlling the belt-to-belt distance and preventing sideways bending. This provides excellent resistance against vibrations and shock loads.
- Flat back construction reduces noise when used with a back side idler or tensioner.
- EPDM rubber compound to ensure a long service life and a wear-resistant belt under extreme temperatures.

BENEFITS

- Service-free PowerBand V-belt with high stability on the toughest drives.
- Halogen-free belt.
- Perfect fit on standard ISO/DIN (for XPZ/XPA/XPB) or RMA (for 3VX/5VX) V-sprockets.
- Manufactured to DIN7753, ISO4184, RMA IP-22.
- Savings in drive space and weight thanks to high transmission efficiency.
- High stability and smooth running on the toughest drives.
- Important design economies possible.
- Static conductive (ISO 1813) and can as such be used in the conditions described in the Directive 2014/34/EU- ATEX.
- RoHS 2 and REACH compliant.
- **Match** system: all sizes meet Gates **UNISET** tolerances, they can be installed without matching.
- Temperature range: -50 °C to +130 °C.

ORDERING CODE

XPB2500/2
XPB - Section
2500 - Datum length (mm)
2 - Number of ribs
NOTE: For correct design and tensioning of the belt please use Gates Design Power software, available on www.gates.com

PLEASE REFER TO P. 132 FOR SIZE LIST.

SECTIONS AND NOMINAL DIMENSIONS								
Section	Standard numbers of ribs				Rib spacing/ Pitch (mm)	Width (mm)	Height (mm)	Length range (datum length - mm)
	2	3	4	5				
XPZ	x	x	x		12.0	10	8	800 - 3550
XPA	x	x			15.0	13	10	800 - 4000
XPB	x	x			19.0	16	13	1250 - 4750
3VX*	x	x	x	x	10.3	10	8	635 - 3555 effective length - mm
5VX*	x	x	x	x	17.5	16	13	1270 - 5080 effective length - mm

Width
Height
Rib spacing/Pitch

*3VX and 5VX are Super HC MN PowerBands. They are not compatible with XPZ and XPB multi strand pulleys. Spacing between strands is different.

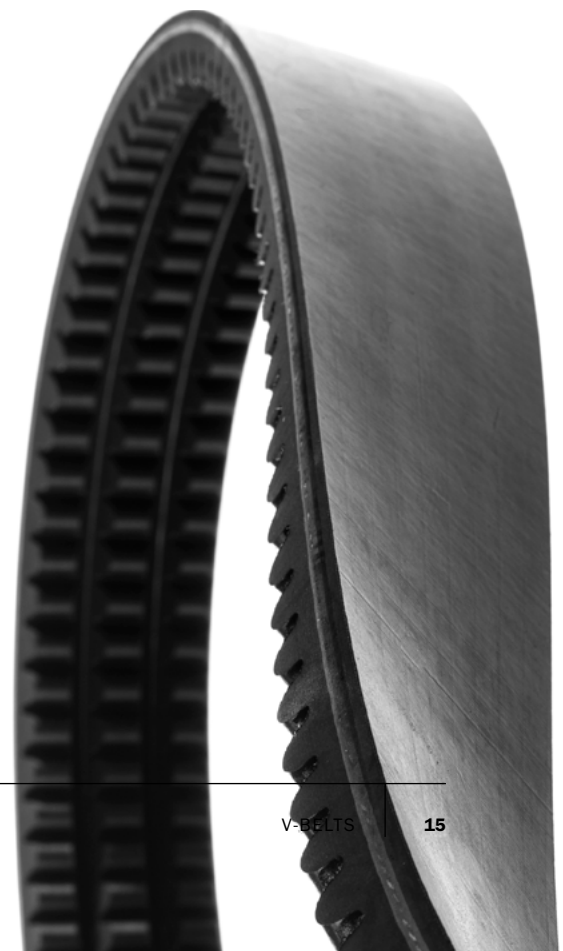



10 SUPER HC & HI-POWER POWERBAND

WRAPPED, NARROW SECTION/CLASSICAL SECTION JOINED V-BELT

Gates Super HC PowerBand and Hi-Power PowerBand offer a solution for drives where single belts vibrate, turn over or jump off the sprockets. They consist of several V-belts joined together by a permanent, highstrength tie band offering a tougher more stable solution compared to a single belt.

CONSTRUCTION

- Strong band controls belt-to-belt distance and prevents sideways bending.
- Flex-bonded tensile cords are vulcanized as one solid unit making the belt highly resistant to tensile and flexing forces, fatigue and shock loads.
- Hi-Power PowerBand B, C and D sections are available on request.
- Concave sides and arched top.
- Flex-Weave™ cover protects the belt core from the toughest environments.
- Elastomeric compound protects the belt against heat, ozone and sunlight.
- Static conductive (ISO 1813) and can as such be used in the conditions described in the Directive 2014/34/EU-ATEX.
- Super HC PowerBand is available in SPB, SPC, 3V(9J), 5V(15J) and 8V(25J) sections.

BENEFITS

- Better resistance to vibrations.
- High stability and smooth running on the toughest drives.
- Important design economies possible.
- Savings in drive space and weight due to high transmission efficiency.
- Available on demand in Matched sets. Contact Customer Service for details.
- REACH and RoHS 2 compliant.
- Temperature range: -30°C to +60°C.

ORDERING CODE

SPB2500/3
SPB - Section
2500 - Datum length (mm)
3 - Number of ribs
NOTE: For correct design and tensioning of the belt please use Gates Design Power software, available on www.gates.com

PLEASE REFER TO P. 135 FOR SIZE LIST - ONLINE

SECTIONS AND NOMINAL DIMENSIONS

Section	Width (mm)	Height (mm)	Rib spacing/ Pitch mm	Available number of ribs	Length range (datum length - mm)
SUPER HC POWERBAND					
SPB	16	13	19.00	2 · 16	2120 - 8000
SPC	22	18	25.50	2 · 12	3000 - 11200
3V/9J	10	8	10.30	2 · 30	1400 - 3550 effective length - mm
5V/15J	16	13	17.50	2 · 16	1400 - 9000 effective length - mm
8V/25J	26	23	28.60	2 · 12	2540 - 15240 effective length - mm
HI-POWER POWERBAND					
B	17	10	19.05	2 · 12	935 - 8009 effective length - mm
C	22	12	25.40	2 · 12	1598 - 10688 effective length - mm
D	32	19	36.53	2 · 8	3132 - 16784 effective length - mm

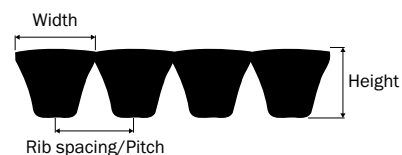

11 HI-POWER DUBL-V

WRAPPED CLASSICAL SECTION DOUBLE SIDED V-BELT

Gates' Hi-Power DUBL-V belt is characterised by a double-V profile. It uses flex-bonded tensile cords, which are highly resistant to flexing forces, and a protective Flex-Weave cover. It is the ideal solution for "serpentine" drives (drives with counter rotating shafts) where power is transmitted from both the top and the bottom of the belts. This belt is designed with a unique recessed top and bottom to maintain sidewall contact, while remaining flexible for drives that require power transmission from both sides of the belt. Suitable for all industrial serpentine applications requiring rotation reversal on some driven shafts.

CONSTRUCTION

- Gates curves provide proper cord support and full contact with the sheave-groove for uniform loading, uniform wear, and increased belt life.
- Flex-Bonded cords are strongly bonded to the body of the belt resulting in equal load distribution and the absorption of bending stress without cord deterioration.
- The Flex-Weave cover is a patented construction for longer cover life, providing extended protection to the core of the belt from oil, dirt, and heat.
- Classical cross-section.

BENEFITS

- Power transmission from both sides of the belt.
- Premium performance.
- Suitable for dirty/dusty environments.
- Static conductive (ISO 1813) and can as such be used in the conditions described in the Directive 2014/34/EU- ATEX.
- **Match** system: all sizes meet Gates **UNISSET** tolerances, they can be installed without matching. (Hi-Power DUBL-V DD not included in UNISSET tolerances).
- Temperature range: -30 °C to +60 °C.

ORDERING CODE

AA51

AA - Section (double)

51 - Inside length (inch)

NOTE: For correct design and tensioning of the belt please consult with our application engineering team.

PLEASE REFER TO P. 146 FOR SIZE LIST - ONLINE

SECTIONS AND NOMINAL DIMENSIONS

Section	Width (mm)	Height (mm)	Length range (effective length - mm)
AA	13	10	1350 - 3290
BB	17	14	940 - 7635
CC	22	18	1980 - 10690
DD	32	25	7000 - 9160

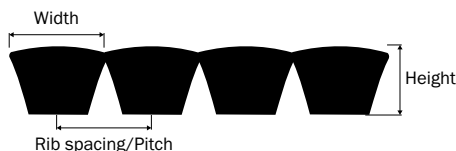



12 MULTI-SPEED

WIDE RAW EDGE V-BELT

Gates Multi-Speed belt provides top performance on variable speed drives. It adjusts itself to the sprocket groove without difficulty, providing a wide range of speeds and speed ratios. In addition to the standard Multi-Speed belt line, special sizes (top width, thickness and angle) are available on request.

CONSTRUCTION

- Engineered notch contour increases flexibility. The notches ensure maximum heat dispersion, considerably decreasing running temperatures.
- Strong transverse rigidity offers high resistance to distortion of the belt in the sprocket. This results in even load distribution and wear reduction.
- Uniform composition and thickness of the undercord ensure smooth and silent running.
- Combination of these construction features gives maximum speed adjustment.

BENEFITS

- Maximum range of speed changes.
- High load-carrying capacity.
- Smooth machine operation.
- Exceptionally long belt life.
- Temperature range: -30°C up to +60°C.



ORDERING CODE	
W16-630	W16 - Section
	630 - Datum length (mm)
23X8-600	23 - Section
	8 - Thickness (mm)
	600 - Inside length (mm)
NOTE: For correct design and tensioning of the belt please consult with our application engineering team.	
PLEASE REFER TO P. 146 FOR SIZE LIST - ONLINE	

SECTIONS AND NOMINAL DIMENSIONS					
	Reference	Top width (mm)	Thickness (mm)	Angle (°)	Length range (inside length - mm)
Gates special size	13	13	6	26	600 - 900
	23	23	8	26	525 - 1500
	28	28	9	26	650 - 1600
	37	37	10	28	800 - 2240
	47	47	13	28	1000 - 2240
	Reference	Top width (mm)	Thickness (mm)	Angle (°)	Length range (datum length - mm)
ISO R1604 sizes	W16	17	6	24	630 - 1000
	W20	21	7	26	630 - 1250
	W25	26	8	26	710 - 1600
	W31.5	33	10	26	900 - 2000
	W40	42	13	28	1120 - 2500
	W50	52	16	28	1400 - 3150
	W63	65	20	30	1800 - 3150

W16



13 POWERATED

GREEN TEXTILE WRAPPED V-BELT

Powerated V-belt is recommended for heavy-duty drives and clutching applications. It meets the requirements of high power, clutching ability, heavy shock load absorption and back idler driven lawn and garden equipment.

CONSTRUCTION

- Aramid tensile cords combine limited stretch with extraordinary strength and durability.
- Low cord positioning in thin profile gives extreme flexibility.
- Distinct green color bareback low friction wrapping provide smooth clutching operation.
- Fabric reinforcement on the bottom ensures high crack resistance if back idler is used.

BENEFITS

- Smooth clutching and disengaging.
- Length stability.
- Special shock resistance.
- Special bending and crack resist.
- Temperature range: -30°C up to +60°C.

ORDERING CODE

3L16
3L - Section
16 - Outside length (inch)
NOTE: For correct design and tensioning of the belt please consult with our application engineering team.

PLEASE REFER TO P. 147 FOR SIZE LIST - ONLINE

SECTIONS AND NOMINAL DIMENSIONS

Section	Width (mm)	Height (mm)	Length range (outside length - mm)
3L	3/8	7/32	406 - 1549
4L	1/2	5/16	432 - 2972
5L	21/32	3/8	635 - 2515

 3L (1)	 4L (2)	 5L (3)
-------------------	-------------------	-------------------





14 POLYFLEX

POLYURETHANE V-BELT

This compact and strong belt with nominal top width from 3mm to 11mm transmits more power and allows high speed ratios. Polyflex is suited for extremely small diameter sprockets and very compact drives with high rotational speeds. Ideal for use on machines and machine tools requiring high performance and smooth operation in limited space such as bench type milling machines, lathe drives, woodworking and metalworking machine spindle drives, computer peripheral equipment, small blowers, etc.

CONSTRUCTION

- High modulus, new formulated polyurethane compound, superior to conventional belt materials, offers high fatigue and wear resistance and a high friction coefficient. It also improves adhesion to the tensile cords.
- Polyurethane is extremely resistant to heat, chemicals and oil.
- Uniformity throughout Polyflex is ensured because the polyurethane compound is not layered but cast without overlaps for smooth running and low vibration.
- Ribbed top provides lateral rigidity without increasing bending stresses.
- The 60° angle results in better support of the tensile section, and provides a more even load distribution.

BENEFITS

- Design freedom and space savings which are not possible with conventional rubber construction belts.
- Low maintenance cost as belt needs less re-tensioning.
- Long belt life on compact drives.
- Available on demand as Matched sets. Contact Customer Service for details.
- Temperature range: -54 °C up to +85 °C.

ORDERING CODE

5M1250
 5M - Section
 1250 - Effective length (mm)
NOTE: For correct design and tensioning of the belt please use Gates Design Power software, available on www.gates.com

PLEASE REFER TO P. 147 FOR SIZE LIST - ONLINE

SECTIONS AND NOMINAL DIMENSIONS

Section	Width (mm)	Height (mm)	Length range (effective length - mm)
3M	3	2.28	180 - 750
5M	5	3.30	280 - 1850
7M	7	5.33	500 - 2300
11M	11	6.85	710 - 2300

 3mm 2.28mm 3M	 5mm 3.30mm 5M	 7mm 5.33mm 7M	 11mm 6.85mm 11M
--------------------------------	--------------------------------	--------------------------------	----------------------------------





15 POLYFLEX JB

POLYURETHANE JOINED V-BELT

Polyflex JB is synonymous with high power density in small spaces. Developed by Gates and produced to patented manufacturing processes, these belts provide more load-carrying capacity at higher speeds to small multiple V-belt precision drives. This results in significant cost savings and improved design freedom. Polyflex JB belts are recommended for use on bench type milling machines, lathe drives, woodworking and metalworking machine spindle drives, computer peripheral equipment, small blowers, etc. They are available in 3M-JB, 5M-JB, 7M-JB and 11M-JB sections.

CONSTRUCTION

- JB = Joined Belt construction improves stability.
- Ribs relieve bending stress on small sprockets and provide lateral rigidity.
- The 60° angle provides more undercord support to the tensile section and distributes the load more evenly.
- Small cross-section meets special application needs such as high shaft speeds, small drive package size and smooth running requirements.
- High modulus polyurethane compound with a high friction coefficient.
- The precise casting method eliminates overlaps and layers.
- Excellent adhesion of tensile cords and polyurethane compound leads to high fatigue resistance and long belt life.
- Extra toughness. The polyurethane compound resists fatigue, wear and ozone.

BENEFITS

- Long belt life on small sprockets and compact drives.
- Greater shaft speeds, up to 30,000 rpm.
- High performance and smooth running for precision applications.
- Cost savings and design freedom.
- Avoids vibrations when subjected to shock loads.
- Available on demand in Matched sets. Contact Customer Service for details.
- Temperature range: -54 °C up to +85 °C.

ORDERING CODE

5M280/3

5M - Section

280 - Effective length (mm)

3 - Number of ribs (joined belt)

NOTE: For correct design and tensioning of the belt please use Gates Design Power software, available on www.gates.com

PLEASE REFER TO P. 147 FOR SIZE LIST - ONLINE

SECTIONS AND NOMINAL DIMENSIONS

Section	Standard numbers of ribs				Width (mm)	Height (mm)	Rib spacing/ Pitch (mm)	Length range (effective length - mm)
	2	3	4	5				
3M-JB	x	x			3	2.28	3.35	175 - 750
5M-JB	x	x	x	x	5	3.30	5.30	280 - 1500
7M-JB	x	x	x	x	7	5.33	8.50	490 - 2293
11M-JB	x	x			11	7.06	13.20	692 - 2282

<p>Rib spacing / Pitch 3M</p>	<p>Rib spacing / Pitch 5M</p>	<p>Rib spacing / Pitch 7M</p>	<p>Rib spacing / Pitch 11M</p>
--	--	--	---

Other number of ribs available on request.
For detailed info, please contact your Gates representative.





16 MICRO-V

MULTI-RIBBED V-BELT

Gates Micro-V belts ensure outstanding performance on any industrial multi-ribbed drive. They cover a multitude of industrial applications and are suitable for industrial drives in washing machines, textile machines, vacuum cleaners, lawn mowers, machine tools, medical equipment and many more. The full line of Micro-V belt products includes slabs in several widths as well as single belts in PJ, PK, PL and PM sections in order to perfectly match customer requirements. Both slabs and belts can be manufactured in a great variety of number of ribs.

CONSTRUCTION

- Truncated ribs ensure flexibility, reduce heat build-up and improve rib crack resistance. They also enhance load-carrying capacity on small diameter sprockets.
- Can be installed on grooved DriveR and flat DriveN sprocket.
- High modulus, low stretch polyester tensile member provides superior resistance to fatigue and shock loads.
- All elastomeric rubber compound provides oil and heat resistance.
- Belts will operate in standard sprockets provided the sprockets are manufactured to the DIN 7867 or ISO 9982 standard for the specific cross-section.
- Specially formulated fibre reinforced undercord that improves belt stability.

BENEFITS

- Extremely smooth and cool running.
- Very high power capacity per rib.
- Long life due to extra load-carrying capacity.
- Improved performance on back idlers.
- Smaller drive package.
- Tolerant of sprocket groove debris.
- Static conductive (ISO 1813) and can as such be used in the conditions described in the Directive 2014/34/EU- ATEX (except PK profile).
- Temperature range:
 - 30 °C to +60 °C (PJ, PL, PM).
 - 50 °C to +120 °C (PK) (EPDM compound).

ORDERING CODE	
PM2286/28	
PM - Section	
2286 - Effective length (mm)	
28 - number of ribs	
NOTE: For correct design and tensioning of the belt please use Gates Design Power software, available on www.gates.com	
PLEASE REFER TO P. 148 FOR SIZE LIST.	

SECTIONS AND NOMINAL DIMENSIONS		
Section	Height (mm)	Rib spacing (mm)
PJ	3.5	2.34
PK	4.45	3.56
PL	6.4	4.70
PM	12.7	9.40

2.34mm Rib spacing/Pitch **PJ**
 3.56mm Rib spacing/Pitch **PK***
 4.70mm Rib spacing/Pitch **PL**
 9.40mm Rib spacing/Pitch **PM**





2. SYNCHRONOUS BELTS



POLY CHAIN RANGE

POLYURETHANE SYNCHRONOUS BELTS

A UNIQUE ALTERNATIVE TO ROLLER CHAIN

Our Poly Chain family of belts offers you the most advanced synchronous belt technology on the market. Upon its introduction more than 30 years ago, this synchronous belt already set the standard for long and reliable service.

The unique construction makes all Poly Chain belts extremely tough and virtually immune to abrasion and chemical attack. Since Poly Chain belts do not require re-tensioning or lubrication they make an excellent alternative to roller chains. Furthermore, they offer a much cleaner and more compact drive solution but at the same or higher power capacity.

BENEFITS

- **MAINTENANCE FREE.**
- Substantial savings in space and weight.
- Outlasts roller chain up to 4 to 1.
- Lower noise levels even at high transport speed.
- Inside and back idlers can be used.

MAKE THE SWITCH TO POLY CHAIN BELTS

Poly Chain belt drives have already been successfully installed and used in a wide variety of applications resulting in large cost-savings and capacity improvements every single time. The following industries are ideal for this maintenance-free technology:

- Industrial equipment (mining, construction, food & beverage, wood, paper, pulp and textile).
- Vehicles and engines (motorcycles and other motor vehicles).
- Lift and handling equipment.
- Machine tools.
- Agricultural and forestry equipment (combines, debarkers, saws).

DISCOVER THE ENTIRE FAMILY

- Poly Chain Carbon VOLT 8MGT & 14MGT – for standard and ATEX environments.
- Mini Poly Chain GT Carbon 8MGT – for conveyor drives.
- Poly Chain GT Carbon 5MGT – for compact performance drives.
- Poly Chain GT Carbon Extended Length Range 14MGT – for the longest center distances.

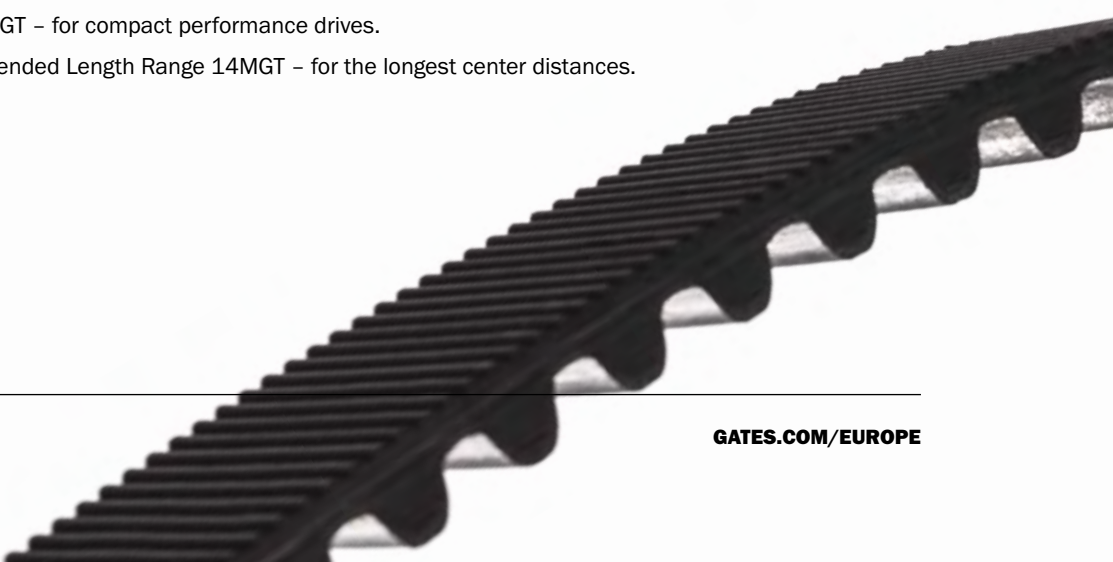

17 POLY CHAIN CARBON VOLT

ANTI-STATIC POLYURETHANE SYNCHRONOUS BELT WITH OPTIMISED CURVILINEAR GT TOOTH

THE POWER YOU WANT, THE SAFETY YOU NEVER HAD

Antistatic power transmission belts are a must in ATEX environments. To ensure the highest safety standards, their capacity to safely dissipate static electricity should meet the required levels over the lifetime of the belt - and not only when new. The Poly Chain Carbon VOLT belt is the only belt in the market that meets the ISO 9563 standard over the complete lifespan of the belt. Its patented static-conductive jacket construction transfers static electricity safely to carbon tensile cords, away from the driven side of the application – making it your safest and strongest option for applications in ATEX environments.

CONSTRUCTION

- **Static conductive** (ISO 9563) and can as such be used in the conditions described in the directive 2014/34/EU- ATEX.
- Chemically resistant **polyurethane compound** that ensures optimum adhesion with the carbon tensile cords.
- **Carbon cord reinforcement** for high strength and length stability.
- **Nylon fabric facing** that acts as a wear resistant surface, protecting the teeth and keeping frictional losses to a minimum.
- **Curvilinear tooth profile** for improved stress distribution and higher overall loading.
- Standard widths of 12, 21, 36, 62mm (8MGT) and 20, 37, 68, 90, 125mm (14MGT). Other widths available on request.

ORDERING CODE

14MGTV-1890-37

14MGT - Pitch 14mm

V - Carbon VOLT version

1890 - Pitch length (mm)

37 - Belt width (mm)

NOTE: For correct design and tensioning of the belt please use Gates Design Power software, available on www.gates.com

Identification

Durable white marking indicating the belt type and belt dimensions.

PLEASE REFER TO P. 155 FOR SIZE LIST.

BENEFITS

- Maintains static conductivity over belt lifetime.
- 25% greater power over previous generation Poly Chain GT2.
- 5% energy savings over V-belts.
- 99% efficiency for life of the drive.
- Reduced maintenance and downtime.
- Reduce weight and overhung loads.
- Inert to most acids, chemicals and water.
- Temperature range: -54 °C to + 85 °C.
- Perfect fit on Poly Chain GT profile sprockets.

SECTIONS AND NOMINAL DIMENSIONS

Section	Pitch (mm)	Tooth height (mm)	Belt height (mm)	Length range (pitch length - mm)
8MGT	8.0	3.4	5.9	640 - 4480
14MGT	14.0	6.0	10.2	994 - 4410

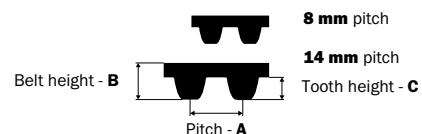

For Poly Chain GT 8MGT and 14MGT sprocket range refer to p. 49, 51, 52, 53.



18 MINI POLY CHAIN GT CARBON 8MGT

POLYURETHANE SYNCHRONOUS BELT WITH OPTIMISED CURVILINEAR GT TOOTH PROFILE

This compact polyurethane synchronous belt opens up new opportunities in the design of conveyor drives and is an alternative to roller chains. Poly Chain GT Carbon does not require lubrication or tensioning and is characterised by low noise levels even at high transport speeds. The special construction is highly resistant to aggressive influences such as dust, oil and chemicals.

CONSTRUCTION

- Teeth and body are made of a lightweight **polyurethane compound**, specially blended for adhesion to the cords and fabric.
- The **carbon fibre tensile cords** provide extraordinary power carrying capacity.
- Nylon fabric facing that acts as a wear resistant surface, protecting the teeth and keeping frictional losses to a minimum.
- Curvilinear tooth profile for improved stress distribution and higher overall loading.
- Standard widths of 11.2, 21, 36, 62 mm. Other widths available on request.

BENEFITS

- Cut maintenance and downtime.
- Withstand shock and surge loads.
- Functions on fixed center drives
- No lubrication required.
- Smooth running roller conveyor.
- Inert to most acids, chemicals and water.
- No need for constant re-tensioning.
- Temperature range: -54 °C to +85 °C.
- Perfect fit on Poly Chain GT profile sprockets.

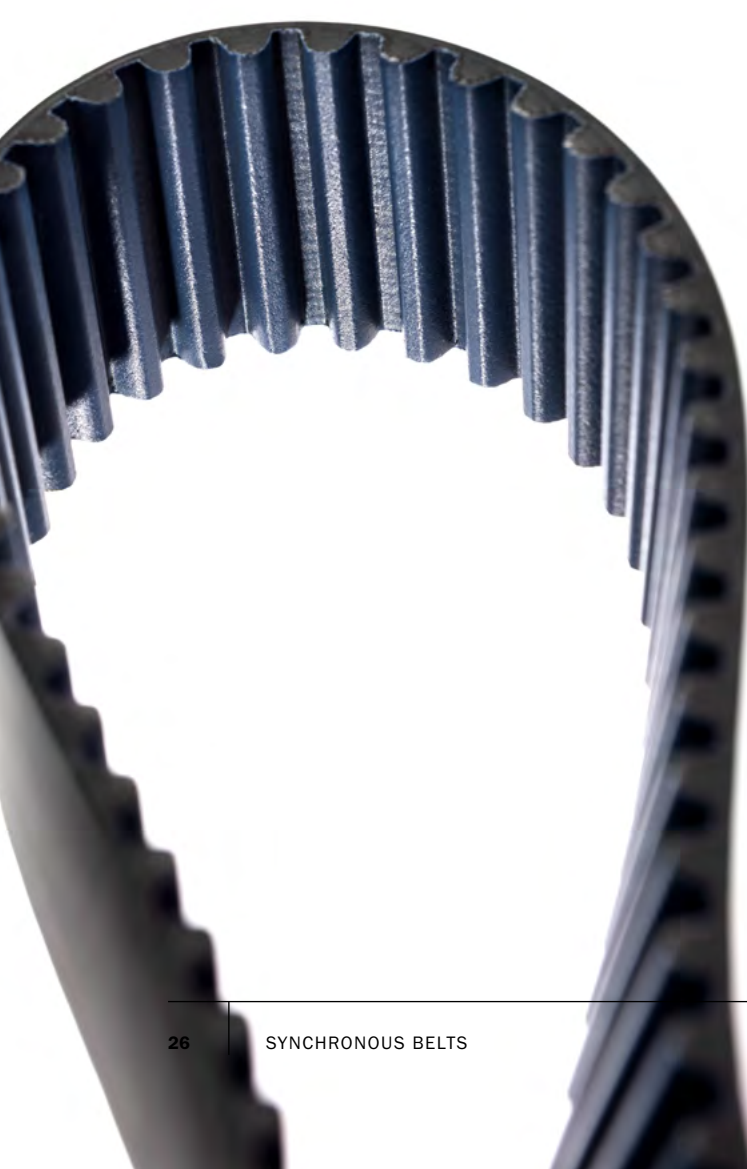

ORDERING CODE

8MC-352-11.2
8M - Pitch 8mm
C - Carbon tensile member
352 - Pitch length (mm)
11.2 - Belt width (mm)
NOTE: For correct design and tensioning of the belt please use Gates Design Power software, available on www.gates.com

Identification

Durable white marking indicating the belt type and belt dimensions.

PLEASE REFER TO P. 160 FOR SIZE LIST.

SECTIONS AND NOMINAL DIMENSIONS

Section	Pitch (mm)	Tooth height (mm)	Belt height (mm)	Length range (pitch length - mm)
8MGT	8.0	3.4	5.9	248 - 608

Belt height - B Tooth height - C
Pitch - A
8 mm

For Poly Chain GT 8MGT sprocket range refer to p. 49.

19 POLY CHAIN GT CARBON 5MGT

POLYURETHANE SYNCHRONOUS BELT WITH OPTIMISED CURVILINEAR GT TOOTH PROFILE

Gates Poly Chain GT Carbon 5MGT uses the original construction which is designed for optimum performance on high torque, low speed drives. Poly Chain GT Carbon 5MGT belts are ideally suited for use in machine tool, roller chain, small conveyors and compact drives where space is a problem. 5MGT Poly Chain GT belts are now available in Gates Carbon construction. This new construction provides the highest capacity and accuracy combination possible in a compact drive.

CONSTRUCTION

- Durable high temperature **polyurethane construction** resists chemicals, oil, pollutants and abrasion.
- Gates patented **curvilinear tooth profile** provides high shear strength and improved load carrying capacity.
- **Nylon tooth facing** reduces friction and eliminates the need for lubrication.
- Robust **carbon tensile cord** combines minimal stretch with extraordinary strength while absorbing shock and surge loads.
- Standard widths of 9, 15, 25mm. Other widths available on request.

BENEFITS

- Poly Chain performance on compact drives.
- High efficiency and accuracy positive drive.
- Maintenance free.
- Cut maintenance and downtime.
- Carbon cords easily handle shock loads.
- No lubrication required.
- Inert to most acids, chemicals and water.
- No need for constant re-tensioning.
- Temperature Range: -54 °C to +85 °C.
- Compatible with PowerGrip GT 5MR sprockets.

ORDERING CODE

5MGTC-425-15

5MGT - Pitch 5mm

C - Carbon tensile member

425 - Pitch length (mm)

15 - Belt width (mm)

NOTE: For correct design and tensioning of the belt please use Gates Design Power software, available on www.gates.com

Identification

Durable white marking indicating the belt type and belt dimensions.

PLEASE REFER TO P. 161 FOR SIZE LIST.

SECTIONS AND NOMINAL DIMENSIONS

Section	Pitch (mm)	Tooth height (mm)	Belt height (mm)	Length range (pitch length - mm)
5MGT	5.0	1.93	3.81	300 - 815

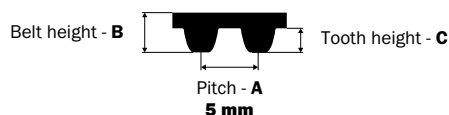

For Poly Chain GT 5MGT sprocket range refer to p. 50.



20 POLY CHAIN GT CARBON EXTENDED LENGTH

POLYURETHANE SYNCHRONOUS BELT WITH OPTIMISED CURVILINEAR GT TOOTH PROFILE

Gates Poly Chain GT Carbon belts are renowned for high performance with no maintenance. Now Gates introduces a Poly Chain solution that can handle longer center distances than ever before. The unique manufacturing process allows longer Poly Chain endless belts that deliver high load carrying capabilities. In the past large and heavy roller chains were the only option for long center distance drives. Now there is an alternative that requires less maintenance, less replacements resulting in less downtime and cleaner operation. The Extended Length process is applied to belt lengths in 14M pitch over 4410 mm.

CONSTRUCTION

- Durable **polyurethane construction** resists chemicals, oil, pollutants and abrasion.
- Gates patented **curvilinear tooth profile** provides high shear strength and improved load carrying capacity.
- **Nylon tooth facing** reduces friction and eliminates the need for lubrication.
- Robust **carbon tensile cord** combines minimal stretch with extraordinary strength while absorbing shock and surge loads.
- Standard widths of 37, 68, 90, 125 mm. Other widths or other lengths are available on request.

BENEFITS

- Long length up to 20.000 mm.
- High power density.
- Lubrication free.
- Maintenance free.
- Stretch free.
- Long belt and sprocket life.
- 96% less weight over chain equivalent.
- Temperature range: -54 °C to +85 °C.
- Perfect fit on Poly Chain GT profile sprockets.

ORDERING CODE

14MGTC-4956-37

14MGT - Pitch 14mm

C - Carbon tensile member

4956 - Pitch length (mm)

37 - Belt width (mm)

NOTE: For correct design and tensioning of the belt please use Gates Design Power software, available on www.gates.com

Identification

Durable white marking indicating the belt type and belt dimensions.

PLEASE REFER TO P. 162 FOR SIZE LIST.

SECTIONS AND NOMINAL DIMENSIONS

Section	Pitch (mm)	Tooth height (mm)	Belt height (mm)	Length range (pitch length - mm)
14MGT	14.0	6.0	10.2	4578 - 9660

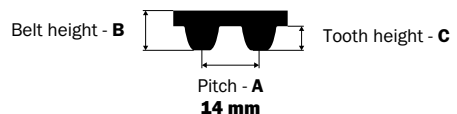

For Poly Chain GT 14MGT sprocket range refer to p. 49.
Other lengths are available on request.
Please consult with your sales representative.

21 POLY CHAIN GT2

POLYURETHANE SYNCHRONOUS BELT WITH OPTIMISED CURVILINEAR GT TOOTH PROFILE

Poly Chain GT2 has been designed for optimum performance on high torque, low speed drives in any industrial application. This lightweight belt features increased power ratings of up to 40% higher than previous constructions while maintaining the same long service life. Poly Chain GT2 operates on Poly Chain GT sprockets. These belts make an excellent alternative to roller chains, requiring neither re-tensioning nor lubrication. Space-saving, weight-saving and money-saving, Poly Chain GT2 drives offer a long and reliable service life.

CONSTRUCTION

- Teeth and body are made of a lightweight **polyurethane compound**, specially blended for adhesion to the cords and fabric. This uniquely formulated polyurethane makes the belt tough and virtually immune to abrasion and chemicals.
- The **aramid tensile cords** provide extraordinary power-carrying capacity.
- The **fabric** covering the teeth is highly resistant to oil, chemicals, pollutants, corrosion and abrasion. It is exceptionally durable and remains fully operational.
- Standard widths of 12, 21, 36, 62mm (8MGT); and 20, 37, 68, 90, 125mm (14MGT).

BENEFITS

- Substantially increased power rating.
- High efficiency positive drive.
- Maintenance-free: no lubrication or re-tensioning needed.
- Savings in space, weight and money.
- Temperatures range: -54 °C to +85 °C.
- Perfect fit on Poly Chain GT profile sprockets.

ORDERING CODE

8MGT-640-12

8MGT - Pitch 8mm
640 - Pitch length (mm)
12 - Belt width (mm)

NOTE: For correct design and tensioning of the belt please use Gates Design Power software, available on www.gates.com

Identification

Durable white marking indicating the belt type and belt dimensions.

PLEASE REFER TO P. 163 FOR SIZE LIST.

SECTIONS AND NOMINAL DIMENSIONS

Section	Pitch (mm)	Tooth height (mm)	Belt height (mm)	Length range (pitch length - mm)
8MGT	8.0	3.4	5.9	640 - 4480
14MGT	14.0	6.0	10.2	994 - 4410

8 mm pitch
14 mm pitch
Tooth height - C
Belt height - B
Pitch - A

For Poly Chain GT 8MGT and 14MGT sprocket range refer to p. 49, 51, 52, 53.



22 POWERGRIP GTX

PREMIUM RUBBER SYNCHRONOUS BELT WITH VERSATILE TOOTH PROFILE

PowerGrip GTX is the newest premium rubber synchronous belt in the Gates belt range. Available in 8M and 14M pitches, this belt is the optimum choice for high-performance, high-torque conditions and quiet operation. Whether it is for a new drive design or for a replacement, PowerGrip GTX is the reliable choice.

CONSTRUCTION

- **High-strength**, low-elongation **fibre glass tensile** cords for extreme shock load resistance.
- Elastomeric backing protects the cords from environmental pollution and frictional wear.
- Low friction **nylon facing** protects the tooth surface against wear.
- Precision-formed and accurately spaced elastomeric teeth.
- **Static conductive** (ISO 9563) and can as such be used in the conditions described in the Directive 2014/34/EU- ATEX.
- Standard available in widths of 20, 30, 40, 50, 65, 85mm (8M) and 20, 40, 55, 85, 115, 170mm (14M). Other widths available on request.
- On demand available in PowerPaint construction, to eliminate paint contamination risk (see p. 40).

BENEFITS

- Easy replacement and upgrade of existing HTD / GT3 / GT4 type applications.
- Reduced overall drive package.
- Increased power capacity of 25% over PowerGrip GT4.
- Reliable operation and trouble-free service, extending the useful life of your system.
- Substantial reduction of your day-to-day operational costs by eliminating downtime and maximising productivity.
- Temperature range: -30 °C to +100 °C.
- Ideal alternative for other high-strength rubber synchronous belts.
- Improve reliability and productivity every time you install Gates PowerGrip GTX.
- Perfect fit on HTD profile sprockets.



ORDERING CODE

2400-8MX-20
2400 - Pitch length (mm)
8MX - Pitch 8mm
20 - Belt width (mm)
NOTE: For correct design and tensioning of the belt please use Gates Design Power software, available on www.gates.com

Identification
 Durable white marking indicating the belt type and belt dimensions.

PLEASE REFER TO P. 168 FOR SIZE LIST.

SECTIONS AND NOMINAL DIMENSIONS

Section	Pitch (mm)	Tooth height (mm)	Belt height (mm)	Length range (pitch length - mm)
8MX	8.0	3.4	5.6	264 - 4400
14MX	14.0	6.0	10.0	784 - 4578

23 POWERGRIP GT3 2MGT, 3MGT & 5MGT

PREMIUM RUBBER SYNCHRONOUS BELT WITH OPTIMISED GT TOOTH PROFILE

This technically advanced belt covers a very wide range of industrial applications. The PowerGrip GT3 belt transmits up to 50% more power than the previous generations of PowerGrip belts. This entire belt range is suited both for new drive designs as well as for replacements on existing drives without any adaptation of the system. The 2MGT, 3MGT and 5MGT pitches are ideal for compact drives on hand tools, business machines, domestic appliances, high precision servomotor drives and multiaxis applications.

CONSTRUCTION

- **Elastomeric** backing protects the cords from environmental pollution and frictional wear.
- Helically wound **fibre glass tensile** member gives enormous strength, flex life and elongation resistance.
- Low friction **nylon facing** protects the tooth surface against wear.
- **Precision-formed** and accurately spaced elastomeric **teeth**.
- 5MGT pitch is on demand available in PowerPaint construction, to eliminate paint contamination risk (see p. 40).
- Standard widths of 3, 6, 9mm (2MGT); 6, 9, 15mm (3MGT); and 9, 15, 25mm (5MGT). Other widths available on request.

BENEFITS

- Substantially increased power ratings.
- Compact drives and less weight.
- High positioning accuracy.
- Improved tooth jump resistance.
- Reduced noise levels.
- Cost-effective, long-lasting and virtually maintenance-free.
- Temperature range: -30 °C to +100 °C.
- Compatible with and used on GT type sprockets.
- Replaces previous generation PowerGrip GT 2MR, 3MR, 5MR products.
- Drop-in equivalent and compatible with Unitta 2GT, 3GT and 5GT profile.

ORDERING CODE

285-5MGT3-9

285 - Pitch length (mm)

5MGT3 - Pitch 5mm

9 - Belt width (mm)

NOTE: For correct design and tensioning of the belt please use Gates Design Power software, available on www.gates.com

Identification

Durable white marking indicating the belt type and belt dimensions.

PLEASE REFER TO P. 186 FOR SIZE LIST.

SECTIONS AND NOMINAL DIMENSIONS

Section	Pitch (mm)	Tooth height (mm)	Belt height (mm)	Length range (pitch length - mm)
2MGT	2.0	0.71	1.52	74 - 1830
3MGT	3.0	1.12	2.41	105 - 1692
5MGT	5.0	1.92	3.81	200 - 2440

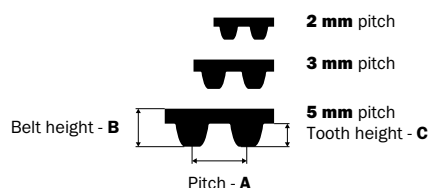

24 POWERGRIP GT4 8MGT & 14MGT

PREMIUM EPDM RUBBER SYNCHRONOUS BELT WITH OPTIMISED GT TOOTH PROFILE

Engineered with the latest in advanced technology and materials science expertise, Gates PowerGrip GT4 delivers the highest power-carrying capacity of any belt in its class. Utilising all new advanced materials, Gates designed an ethylene elastomer belt with increased power capacity and wider temperature range capability. The NEW PowerGrip GT4 belt delivers improved performance over a wide range of industrial applications. The 8MGT and 14MGT pitches are the optimum choice for high performance drives in the machine tool, paper and textile industries where durability and low maintenance are required.

CONSTRUCTION

- Newly engineered **EPDM rubber** protects the cords from environmental pollution and frictional wear.
- Helically wound **fibre glass tensile member** gives enormous strength, flex life and elongation resistance.
- Low friction **nylon facing** protects the tooth surface against wear.
- **Precision-formed** and accurately spaced elastomeric **teeth**.
- Standard widths of 20, 30, 50, 85mm (8MGT); 40, 55, 85, 115, 170mm (14MGT). Other widths available on request.
- **Static conductive** (ISO 9563) and can as such be used in the conditions described in the Directive 2014/34/EU- ATEX.

BENEFITS

- Substantially increased power ratings: up to 25% more than previous PowerGrip GT3 construction.
- Reduced maintenance costs thanks to longer service life.
- Compact, light-weight and cost-effective drives.
- High tooth jump resistance.
- No lubrication needed.
- On demand available in PowerPaint construction, to eliminate paint contamination risk (see p. 40).
- Temperature range: -40°C to +140°C (for intermittent use).
- Halogen-free: environmentally friendly.
- Perfect fit on HTD profile sprockets.



ORDERING CODE

1760-8MGT4-30

1760 - Pitch length (mm)

8MGT4 - Pitch 8mm

30 - Belt width (mm)

NOTE: For correct design and tensioning of the belt please use Gates Design Power software, available on www.gates.com

Identification

Durable white marking indicating the belt type and belt dimensions.

PLEASE REFER TO P. 179 FOR SIZE LIST.

SECTIONS AND NOMINAL DIMENSIONS

Section	Pitch (mm)	Tooth height (mm)	Belt height (mm)	Length range (pitch length - mm)
8MGT	8.0	3.2	5.6	384 - 4400
14MGT	14.0	5.7	9.9	966 - 6860

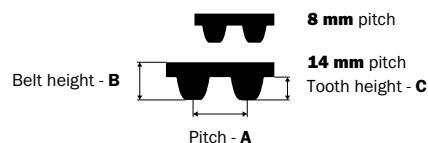

25 POWERGRIP HTD 3M & 5M

RUBBER SYNCHRONOUS BELT WITH HTD TOOTH PROFILE

The HTD curvilinear tooth form ensures an optimised load distribution leading to high power transmission in low speed and high torque applications. PowerGrip HTD 3M and 5M belts are suitable for domestic appliances, office machines, electric hand tools and for applications in the processing and chemical industry.

CONSTRUCTION

- Special **curvilinear tooth** design improves stress distribution and allows higher overall loading.
- Precisely formed and accurately spaced **elastomeric teeth** ensure smooth engagement with the sprocket grooves.
- Durable elastomeric backing protects the belt against environmental pollution as well as frictional wear if power is transmitted from the back of the belt.
- Tough **nylon facing** protects the tooth surface.
- **Fibre glass** tensile cords.
- Belts conform to ISO13050:2014.
- Standard widths of 6, 9, 15mm (3M); 9, 15, 25mm (5M). Other widths available on request.

BENEFITS

- 3M and 5M PowerGrip HTD are designed for speeds up to 20,000 rpm and capacities up to 10 kW.
- The optimized tooth form permits high loads to be transmitted, even in small pitches.
- Peripheral speed up to 80m/s.
- Efficiencies up to 99%.
- Compact design.
- 25% improved tooth jump resistance vs. PowerGrip.
- Long service life and maintenance-free.
- Temperature range: -30 °C to +100 °C.
- Perfect fit on HTD profile sprockets

ORDERING CODE

280-5M-15

280 - Pitch length (mm)

5M - Pitch 5mm

15 - Belt width (mm)

NOTE: For correct design and tensioning of the belt please use Gates Design Power software, available on www.gates.com

Identification

Durable white marking indicating the belt type and belt dimensions.

PLEASE REFER TO P. 196 FOR SIZE LIST.

SECTIONS AND NOMINAL DIMENSIONS

Section	Pitch (mm)	Tooth height (mm)	Belt height (mm)	Length range (pitch length - mm)
3M	3.0	1.2	2.4	105 - 1926
5M	5.0	2.1	3.8	120 - 2350

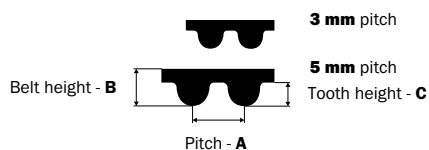

26 POWERGRIP HTD 8M, 14M & 20M

RUBBER SYNCHRONOUS BELT WITH HTD TOOTH PROFILE

The curvilinear PowerGrip HTD tooth geometry eliminates stress concentration at tooth roots and allows higher power capacity and longer life. PowerGrip HTD 8M, 14M and 20M belts are used in high performance drives in the machine tool, paper and textile industries where durability and low maintenance are required.

CONSTRUCTION

- Special **curvilinear tooth** form improves stress distribution and allows higher overall loading.
- Precisely formed and accurately spaced **elastomeric teeth** ensure correct positioning in the sprocket grooves.
- Tough **nylon facing** protects the tooth surfaces.
- **Fibre glass tensile member** provides the required strength combined with excellent flex life and high resistance to elongation.
- Durable **elastomeric backing** protects against environmental pollution as well as frictional wear if power is transmitted from the back of the belt.
- Belts conform to ISO13050:2014.
- Standard widths of 20, 30, 50, 85mm (8M); 40, 55, 85, 115, 170mm (14M); 115, 170, 230, 290, 340mm (20M). Other widths available on request.

BENEFITS

- Load capacities up to 1,000 kW.
- No slippage. PowerGrip HTD belt teeth mesh smoothly with sprocket grooves, eliminating speed variations.
- Wide speed range.
- Economical operation. No lubrication needed, no need for adjustment due to stretch and wear.
- High mechanical efficiency. The belt construction minimizes heat build-up and, since friction is not required to transmit the load, belt tensions are reduced.
- Constant driven speeds.
- Long trouble-free service life (because of excellent abrasion resistance) in many applications where metal components like chains and gears wear out in a matter of months.
- **PowerGrip HTD 14M: static conductive (ISO 9563)** and can as such be used in the conditions described in the Directive 2014/34/EU- ATEX.
- Temperature range: -30 °C to +100 °C.
- Perfect fit on HTD profile sprockets.

SECTIONS AND NOMINAL DIMENSIONS

Section	Pitch (mm)	Tooth height (mm)	Belt height (mm)	Length range (pitch length - mm)
8M	8.0	3.4	5.6	264 - 2800
14M	14.0	6.1	10.0	784 - 4578
20M	20.0	8.4	13.2	2000 - 6600

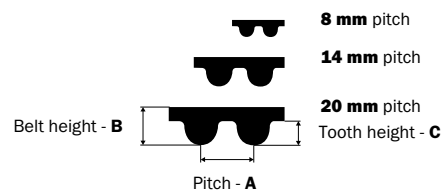

27 POWERGRIP

RUBBER SYNCHRONOUS BELT WITH CLASSICAL TOOTH PROFILE

Gates classical synchronous PowerGrip belt offers a maintenance-free and economical alternative to conventional drives such as chains and gears. Its application range extends from minimum drives (computer printers) to heavy-duty machinery (oil pumps, etc).

CONSTRUCTION

- Trapezoidal tooth form.
- Precisely formed and accurately spaced **elastomeric teeth** ensure correct engagement with the sprocket grooves.
- **Fibre glass tensile** cords.
- **Nylon fabric** cover protects the tooth surfaces.
- Belts conform to ISO19347:2015.
- Standard widths per belt pitch in mm and belt width code:
 - MXL: 3.2mm (code 012), 4.8mm (code 019), 6.4mm (code 025)
 - XL: 6.4mm (code 025), 7.9mm (code 031), 9.5mm (code 037)
 - L: 12.7mm (code 050), 19.1mm (code 075), 25.4mm (code 100)
 - H: 19.1mm (code 075), 25.4mm (code 100), 38.1mm (code 150), 50.8mm (code 200), 76.2mm (code 300)
 - XH/XXH: 50.8mm (code 200), 76.2mm (code 300), 101.6mm (code 400), 127mm (code 500)
- Other widths available on request.

BENEFITS

- Power transmission of up to 150 kW and speeds of up to 10,000 rpm.
- Peripheral speed up to 80m/s.
- Positive slip-proof engagement.
- Constant angular velocity.
- Efficiencies up to 99%.
- Low bearing load because of freedom of high tension.
- Maintenance-free continuity of operation.
- Wide range of load capacities and speed ratios.
- Compact design.
- Economical operation.
- Temperature range: -30 °C to +100 °C.

ORDERING CODE

507-XH-200

507 - Pitch length in 1/10 inch

XH - Pitch 7/8" (22.225mm)

200 - Belt width 2.0" (50.8mm)

288-MXL-019

288 - Pitch length in 1/100 inch

MXL - Pitch 0.08" (2.032mm)

019 - Belt width 0.19" (4.8mm)

NOTE: For correct design and tensioning of the belt please use Gates Design Power software, available on www.gates.com

Identification

Durable white marking indicating the belt type and belt dimensions.

PLEASE REFER TO P. 216 FOR SIZE LIST.

SECTIONS AND NOMINAL DIMENSIONS

Section	Pitch (inch)	Pitch (mm)	Tooth height (mm)	Belt height (mm)	Length range (pitch length - mm)
MXL	2/25 (0.080")	2.032	0.51	1.14	73 - 592
XL	1/5 (0.200")	5.08	1.27	2.3	116 - 1956
L	3/8 (0.375")	9.525	1.91	3.5	314 - 1676
H	1/2 (0.500")	12.7	2.29	4.0	609 - 4318
XH	7/8 (0.875")	22.225	6.36	11.4	1289 - 4445
XXH	1.1/4 (1.250")	31.75	9.53	15.2	1778 - 4572

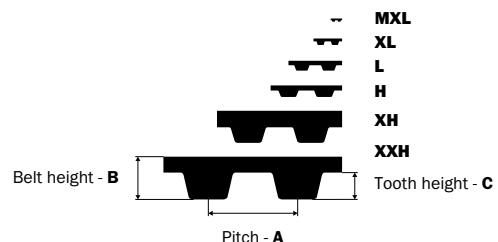

28 TWIN POWER

DOUBLE SIDED RUBBER SYNCHRONOUS BELT

Due to its double and directly opposite teeth, Twin Power synchronous belts ensure high loading capacity on contra-rotating drives and ensure smooth running and high flexibility. They are available with the classical trapezoidal tooth profile and also with the unique GT tooth profile. A Twin Power GT2 belt has twice the power rating of a Twin Power HTD belt. It is characterised by extraordinary load-carrying power and high tooth jump resistance ensuring a positive non-slip drive. In addition, the belt runs at very low noise. Twin Power is available in PowerGrip GT2 8MGT and 14MGT, HTD 5M and PowerGrip XL, L and H pitches.

CONSTRUCTION

- Similar in construction to PowerGrip classical synchronous and PowerGrip GT2 belts: strong **fibre glass tensile** member precision-formed **elastomeric teeth and body**.
- Wear resistant **nylon fabric** on both tooth sides.
- Standard widths per belt pitch in mm and belt width code:
- **Twin Power PowerGrip GT2:**
 - 8MGT: 20, 30, 50, 85mm
 - 14MGT: 40, 55, 85, 115, 170mm
- **Twin Power PowerGrip HTD:**
 - 5M: 9, 15, 25mm
- **Twin Power PowerGrip:**
 - XL: 6.4mm (code 025), 7.9mm (code 031), 9.5mm (code 037)
 - L: 12.7mm (code 050), 19.1mm (code 075), 25.4mm (code 100)
 - H: 19.1mm (code 075), 25.4mm (code 100), 38.1mm (code 150), 50.8mm (code 200), 76.2mm (code 300)
 - Other widths available on request.

BENEFITS

- High loading capacity.
- Twin Power can transmit up to 100% of its maximum rated load from either side of the belt; alternatively, it can transmit a load on both sides - provided the sum of the loads does not exceed the maximum capacity.
- Non-slip positive drive.
- Running at low noise.
- Free of lubrication and maintenance.
- Temperature range: -30°C to +100°C.

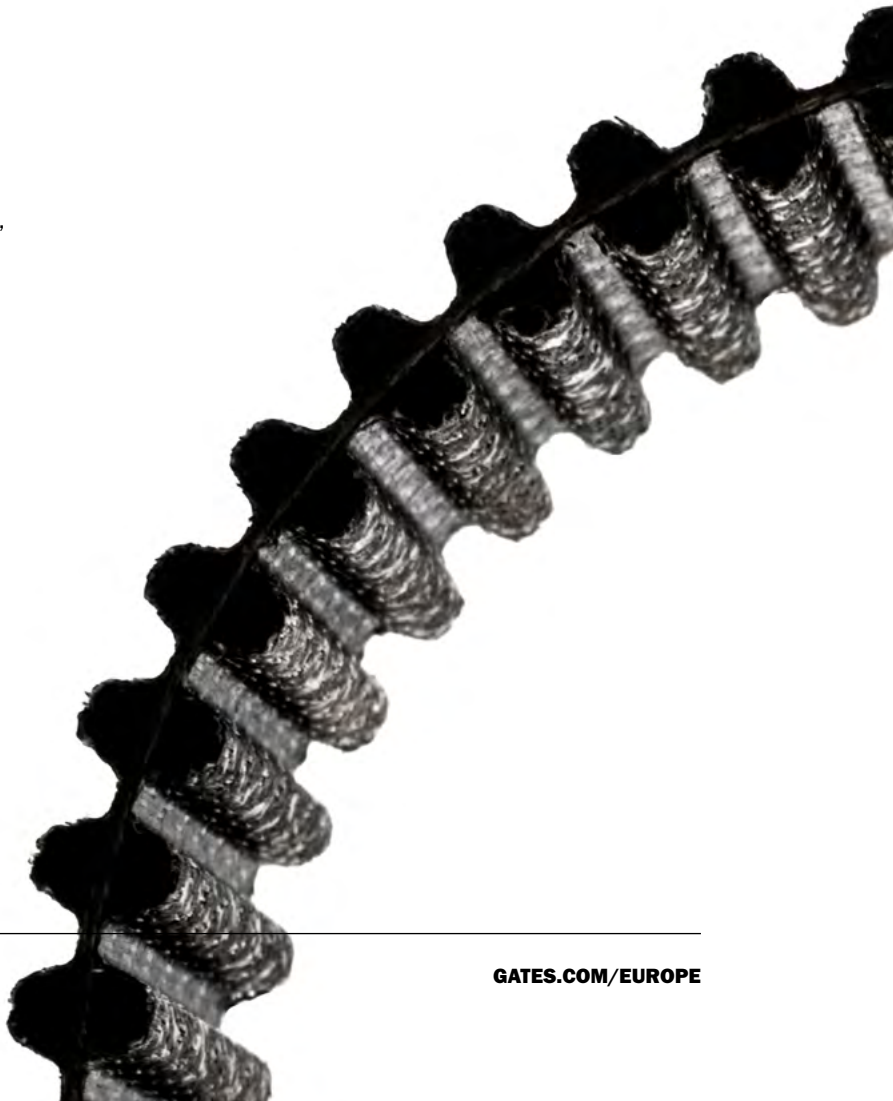



POWERGRIP

Twin Power PowerGrip

Section	Standard widths (mm)	A	B	C
XL	1/4, 3/8	5.08 mm	1.14 mm	0.51 mm
L	1/2, 3/4, 1	9.53 mm	2.30 mm	1.27 mm
H	3/4, 1, 1-1/2, 2, 3	12.70 mm	15.20 mm	9.53 mm

Example: **TP-800-H-100**

Twin Power PowerGrip GT2

Section	Standard widths (mm)	A	B	C
5M (HTD)	9, 15, 25	5 mm	1.14 mm	0.51 mm
8MGT	20, 30, 50, 85	8 mm	2.30 mm	1.27 mm
14MGT	40, 55, 85, 115, 170	14 mm	15.20 mm	9.53 mm

Example: **TP-1200-8MGT2-20**

SECTIONS AND NOMINAL DIMENSIONS

Section	Pitch	Web gauge (mm)	Tooth height (mm)	Length range (pitch length - mm)
---------	-------	----------------	-------------------	----------------------------------

TWIN POWER POWERGRIP GT2

8MGT	8.0mm	2.00	3.40	480 - 4960
14MGT	14.0mm	3.70	5.82	1610 - 6860

TWIN POWER POWERGRIP HTD

5M	5.0mm	1.5	2.1	425 - 2525
----	-------	-----	-----	------------

TWIN POWER POWERGRIP

XL	1/5" (0.200")	0.508	1.27	381 - 894
L	3/8" (0.375")	0.762	1.91	514 - 1676
H	1/2" (0.500")	1.372	2.29	609 - 4318

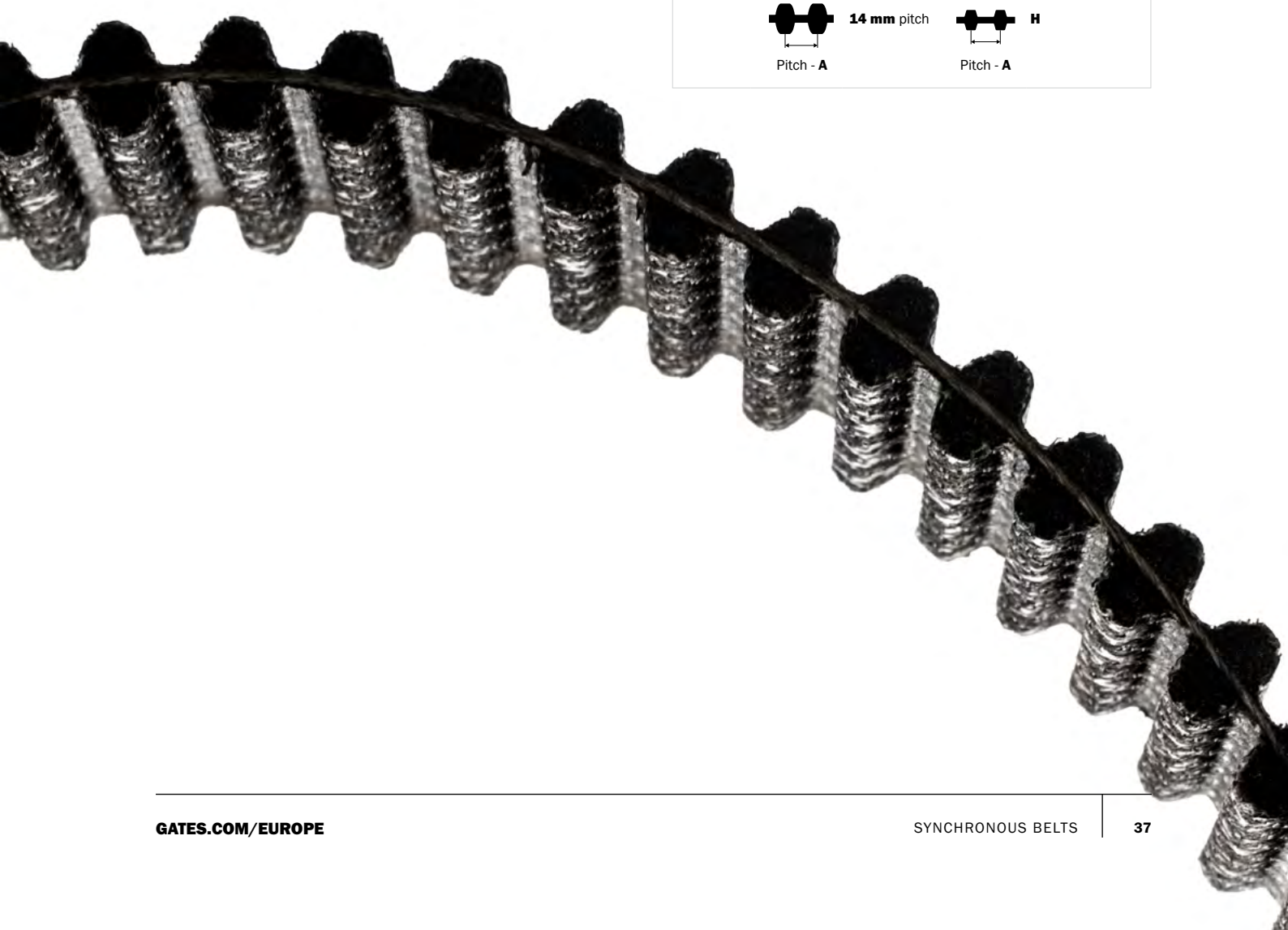
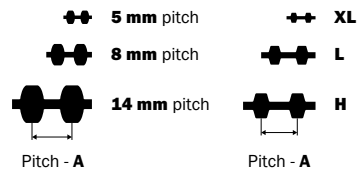

29 LONG LENGTH

OPEN ENDED RUBBER AND POLYURETHANE SYNCHRONOUS BELT

A comprehensive range of open-ended belts which can be easily cut to the required length. Long Length open-end synchronous belts are especially suited for linear movements (automated doors, warehouse conveyors and elevators), accurate positioning (machine tools, x-y co-ordinate machines) and reversal drives (computers, printers and office equipment).

CONSTRUCTION

POWERGRIP GT - 2MR, 3MR, 5MR AND 8MR PITCHES POWERGRIP HTD - 3M, 5M, 8M AND 14M PITCHES POWERGRIP - MXL, XL, L AND H PITCHES

- Fibre glass or steel tensile cords.
- Rubber teeth and backing.
- Nylon facing.

POLY CHAIN GT CARBON 8MGT AND 14MGT PITCHES

- Carbon tensile cord.
- Polyurethane teeth and backing.
- Fabric reinforced teeth.
- On demand available in PowerPainT construction, to eliminate paint contamination risk (see p. 40).
- Other roll lengths and belt widths, available on request. Please contact your customer service representative.

BENEFITS

- High positioning accuracy, making the belt ideally suited for applications with repetitive movements.
- Length stability due to the use of high modulus tensile members.
- Easy to attach with clamping fixtures.
- Maintenance-free: no re-tensioning required, no lubrication needed.
- Unique straight cut production methodology: cord perpendicular to belt teeth.
- Temperature range: -30 °C to +100 °C (PowerGrip) and -54 °C to +85 °C (Poly Chain).

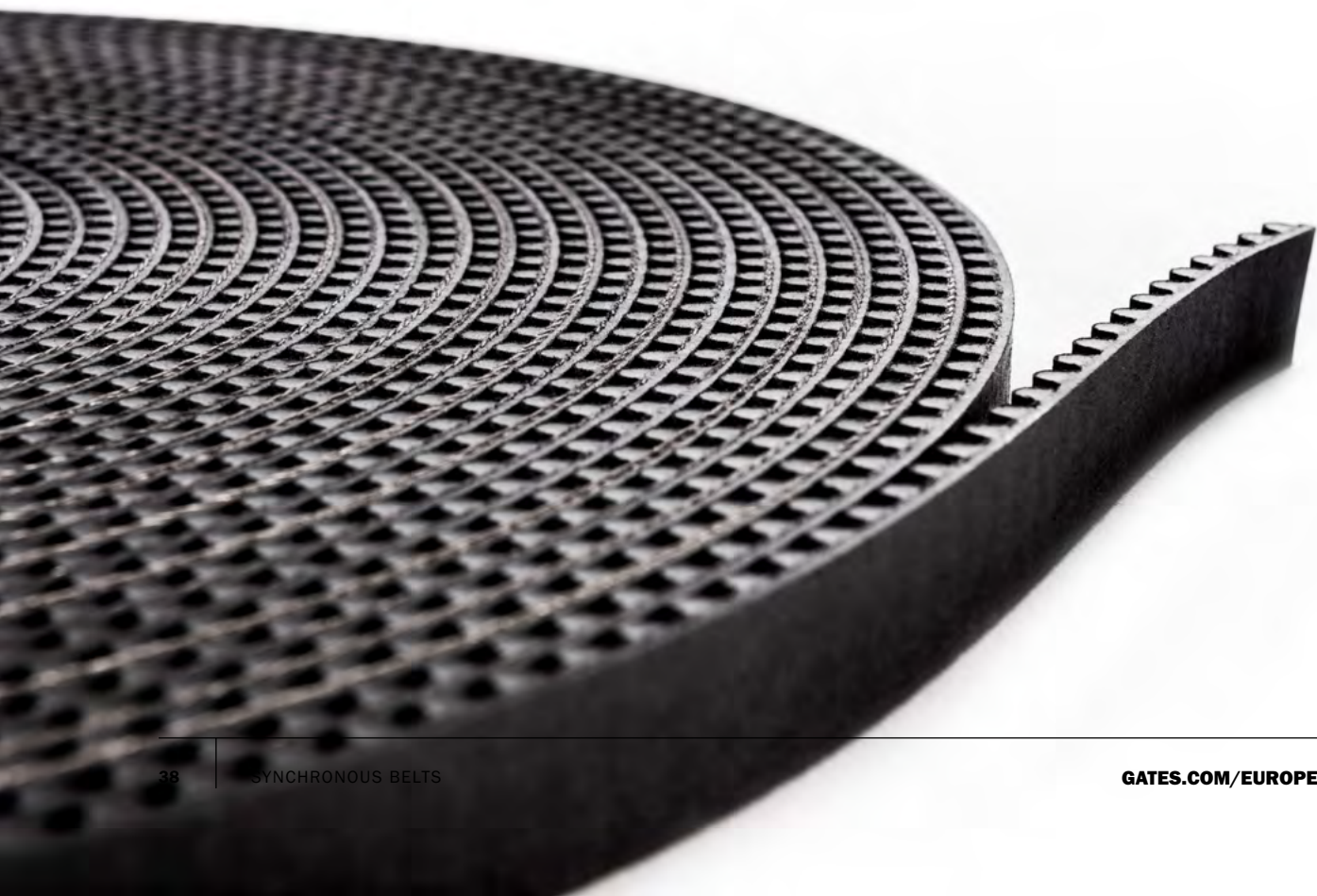

29 LONG LENGTH

OPEN ENDED RUBBER AND POLYURETHANE SYNCHRONOUS BELT

LONG LENGTH

Poly Chain GT Carbon

Section	Pitch (mm)	Tooth height (mm)	Belt height (mm)	Length on roll (m)	Width (mm)
8MGT	8.00	3.40	5.90	30	12, 21, 36
14MGT	14.00	6.00	10.20	30	20, 37

PowerGrip GT

Section	Pitch (mm)	Tooth height (mm)	Belt height (mm)	Length on roll (m)	Width (mm)	
					Fiber Glass	Steel
2MR	2.00	0.71	1.52	/	3, 6, 9	/
3MR	3.00	1.12	2.41	30	6, 9, 15	/
5MR	5.00	1.92	3.81	30	6, 10, 15, 25	6, 10, 15, 25
8MR	8.00	3.34	5.60	30	10, 15, 20, 30, 50	10, 15, 20, 30, 50

PowerGrip HTD

Section	Pitch (mm)	Tooth height (mm)	Belt height (mm)	Length on roll (m)	Width (mm)	
					Fiber Glass	Steel
3M	3.00	1.10	2.40	30	6, 9, 15	/
5M	5.00	2.10	3.80	30	6, 10, 15, 25	6, 10, 15, 25
8M	8.00	3.40	6.00	30	10, 15, 20, 30, 50, 85	10, 15, 20, 30, 50, 85
14M	14.00	6.00	10.00	30	25, 40, 55, 85, 115	25, 40, 55, 85, 115

PowerGrip

Section	Pitch		Tooth height (mm)	Belt height (mm)	Length on roll (m)	Width (mm)	
	(inch)	(mm)				Fiber Glass	Steel
MXL	2/25	2.032	0.51	1.14	/	019, 025, 050	/
XL	1/5	5.080	1.27	2.30	30	025, 031, 037, 050	/
L	3/8	9.525	1.91	3.60	30	037, 050, 075, 100	/
H	1/2	12.7	2.29	4.30	30	050, 075, 100, 150, 200, 300	050, 075, 100, 150, 200, 300

Minimum order quantity: 30 m in fiberglass or steel PowerGrip construction, 30 m Poly Chain GT Carbon construction.
Refer to the Gates industrial power transmission catalogue (E2/20211) for widths and minimum order quantities.

ORDERING CODE

5M-6-30m-ST

5M - Pitch 5mm

6 - Belt width (mm)

30m - Length on roll (m)

ST - Steel (material of tensile cords)

NOTE: For correct design and tensioning of the belt please consult the product application engineering team.

Identification

Durable white marking indicating the belt type and belt dimensions.

PLEASE REFER TO P. 256 FOR SIZE LIST.

30 POWERPAIN^T

PAINT AND VARNISH COMPATIBLE SYNCHRONOUS BELT

Gates' PowerPain^T synchronous belt is specifically developed for use in painting areas, as found in the automotive and white goods industries where contamination of the painted product, from whatever source, is unacceptable. PowerPain^T ensures excellent performance on skid and roller conveyor systems and eliminates the risk of product contamination.

CONSTRUCTION

- Precision-formed **elastomeric teeth** with curvilinear profile improve stress distribution and provide high power capacity.
- Accurately spaced teeth provide high positioning accuracy and optimum efficiency.
- Tough **tensile cords** ensure excellent flex life and high resistance to elongation.

Available in:

- PowerGrip GTX 8MGT and 14MGT
- PowerGrip GT4 8MGT and 14MGT
- PowerGrip GT3 5MGT
- PowerGrip HTD 3M, 5M, 8M and 14M

Long Length:

- Long Length PowerGrip GT 3MR, 5MR and 8MR
- PowerGrip HTD 3M, 5M, 8M and 14M
- PowerGrip XL, L and H

BENEFITS

- No paint contamination risk.
- Runs well on fixed centre distance drives without elongation and offers long service life.
- Identical performance, drive characteristics as standard product.
- Temperature range:
 - PowerGrip: -30°C to +100°C
 - PowerGrip GT4: -40°C to +140°C

ORDERING CODE

PPT-800-8MGT4-30

PPT - PowerPain^T

800 - Pitch length (mm)

8MGT4 - Pitch 8mm (PowerGrip GT4) 30 Belt width (mm)

NOTE: For correct design and tensioning of the belt please use Gates Design Power software, available on www.gates.com or consult the product application engineering team.

Identification

Durable yellow marking indicating the belt type and white marking indicating the belt dimensions.

PLEASE REFER TO P. 240 FOR SIZE LIST.





3.

**POLYURETHANE
BELTS**



31 SYNCHRO-POWER SLEEVE

ENDLESS/OPEN-END POLYURETHANE SYNCHRONOUS BELT

SLEEVE BELTS

Gates TPU Synchro-Power Sleeve Belts are designed to meet the higher strength and stiffness requirements that certain power transmission and high-performance positioning applications demand.

Our Synchro-Power Sleeves belts are cast on fixed molds and have continuously wound steel cords that provide more strength and stiffness than a welded belt can provide. They are manufactured in various exact sizes, constructions, and pitches to fulfill customer requirements.

Cast endless belts offer premium capacity for power transmission and rotary positioning applications while meeting a broad range of loads, speeds, and application requirements.

ATTRIBUTES

- High quality thermo-set polyurethane construction
- Helically wound steel cords for high strength, truly endless power transmission capabilities.
- Excellent abrasion resistance
- Smooth, low noise, non-marking operation
- High tooth strength reduces deforming under load
- Excellent resistance to chemicals

APPLICATIONS

- Paper processing industry
- Wood processing industry
- Glass processing industry
- Textile industry
- Packaging machines
- Exercise equipment

**ORDERING CODE:
ENDLESS SYNCHRO-POWER**

T10-440-50
T10 - Pitch T10 (10mm)
440 - Pitch length (mm)
50 - Belt width (mm)

Identification
 Durable marking indicating the belt type and dimensions

SYNCHRO-POWER	
Synchro-Power Belts	
Section	A
T2.5	2.5 mm
T5	5 mm
T10	10 mm
AT5	5 mm
AT10	10 mm
DT5	5 mm
DT10	10 mm

Example: **T5-270-8**

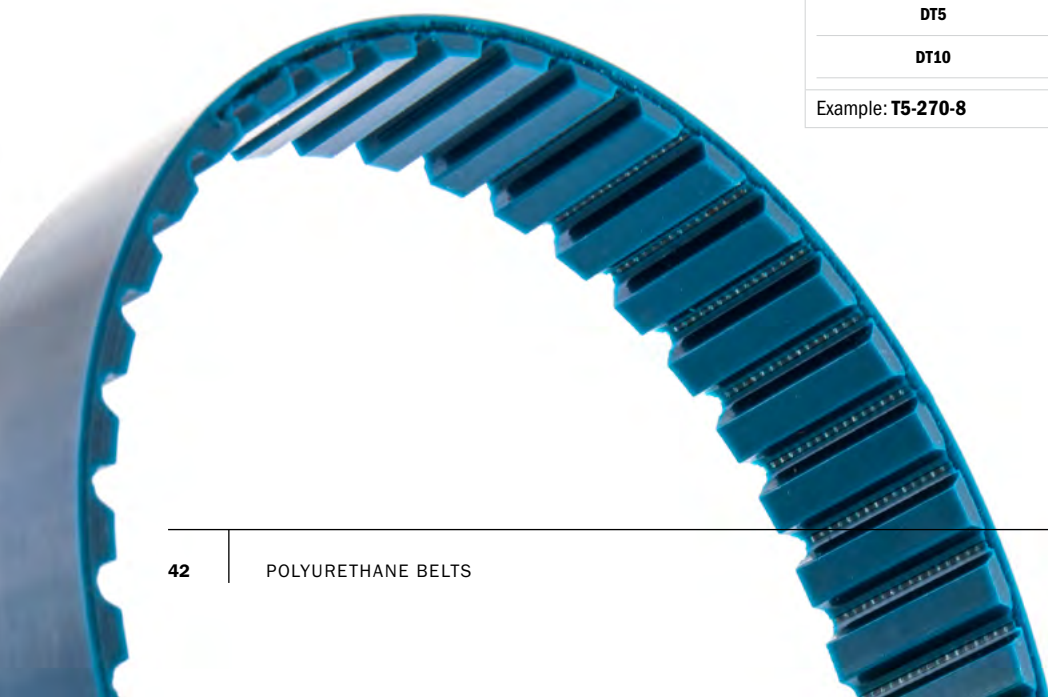



32 CUSTOMISED POLYURETHANE BELTS

Gates' standard Synchro-Power product range covers a multitude of applications. If your process requires a belt design that meets very specific application needs, Gates offers you a variety of customised polyurethane belt products next to the standard belt range. These polyurethane belt products, tailor-made to fulfil your most challenging requirements, meet the same quality levels as their standard counterparts. Our applications engineers can work with you to design any belt catering to your specific needs in various applications. Nearly every belt type can be customised by adding backings, profiles or special machining. This makes them the perfect supplement to the Gates' standard Synchro-Power product offering.



The extensive product range and technical data can be found on [Gates.com](https://www.gates.com). Information of other options and special constructions can be obtained on request from the Gates customer experience team in Pfungstadt (+49 06157 9727 0 or sales-pfungstadt@gates.com).



33 SYNCHRO-POWER FLEX

HIGH-QUALITY, THERMOPLASTIC BELTS MANUFACTURED AS TRULY ENDLESS, EXTRUDED SYNCHRONOUS BELTS

FLEX BELTS

Gates TPU Synchro-Power Flex Belts are designed for high power transmission drives and heavy load conveying applications.

Our flex belts are available in both standard and low-temperature urethanes to suit a range of application environments. Enhanced with our full range of backing and profile options, we are able to create customized conveying and positioning solutions.

Flex belts are truly endless extruded belts produced with helically wound steel cords and abrasion-resistant polyurethane, a construction that provides long lasting belt system solutions for even the most demanding industries and applications.

ATTRIBUTES

- Extruded, thermoplastic polyurethane construction
- High performance and power transmission based on truly endless cords
- Synchronous tracking

APPLICATIONS

- Glass & Ceramics
- Packaging
- Intralogistics
- Wood, Paper & Furniture
- Textile industry
- Machine tools
- Power transmission
- High load conveying applications

Further constructions are available on request.

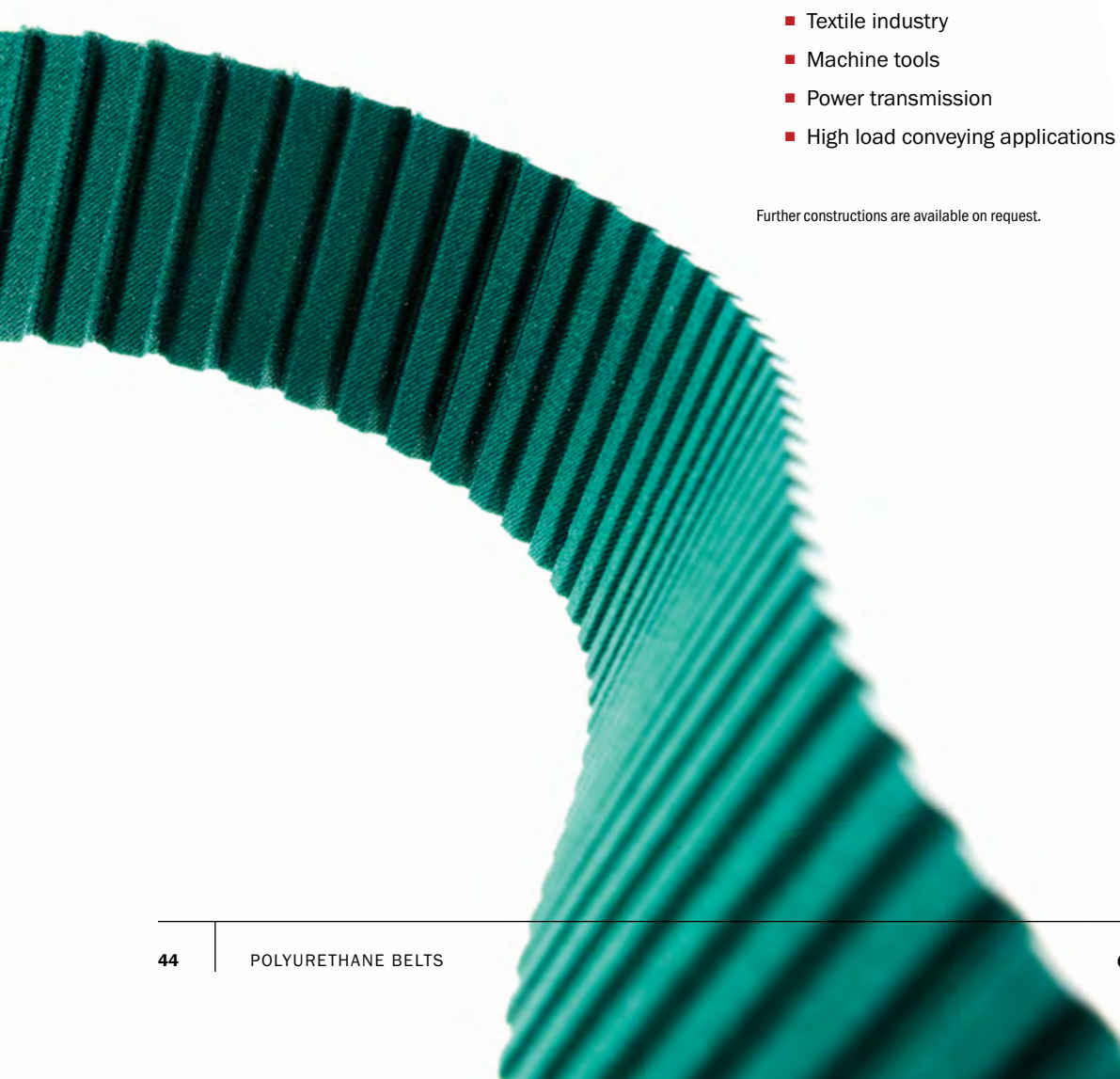



34 SYNCHRO-POWER LINEAR

FLEXIBLE SOLUTIONS FOR SYNCHRONOUS CONVEYING AND LINEAR POSITIONING APPLICATIONS

TIMING BELTS

Gates TPU linear timing belts are manufactured in standard roll lengths in different pitches, constructions and tooth shapes. The wide range of various designs offers the exact solution for nearly every application. Linear belts are available as roll stock, open ended (long length), pre-punched or endless, thermal welded belts.

For special custom applications, the belts can be coated with various backings and/or manufactured with welded on profiles.

Gates TPU linear belts are designed to ensure high grade performance for both, power transmission and linear applications and can be used for a broad range of demands, speeds, and applications.

ATTRIBUTES

- Thermoplastic polyurethane construction
- High tensile strength and stiffness
- Parallel cord construction for uniform tensioning
- Smooth, low-noise operation
- Temperature range:
Standard TPU: R1 - 5° to + 70° C
Low temp TPU: R23T - 30° to + 50° C
- Extended service temperature range is available on request
- FDA and EU food approval for various pitches

APPLICATIONS

- Conveying- and handling equipment
- Linear applications
- Vertical Lifting
- Synchronous conveying applications
- Automatic assembly machines
- Door drives
- Textile industry

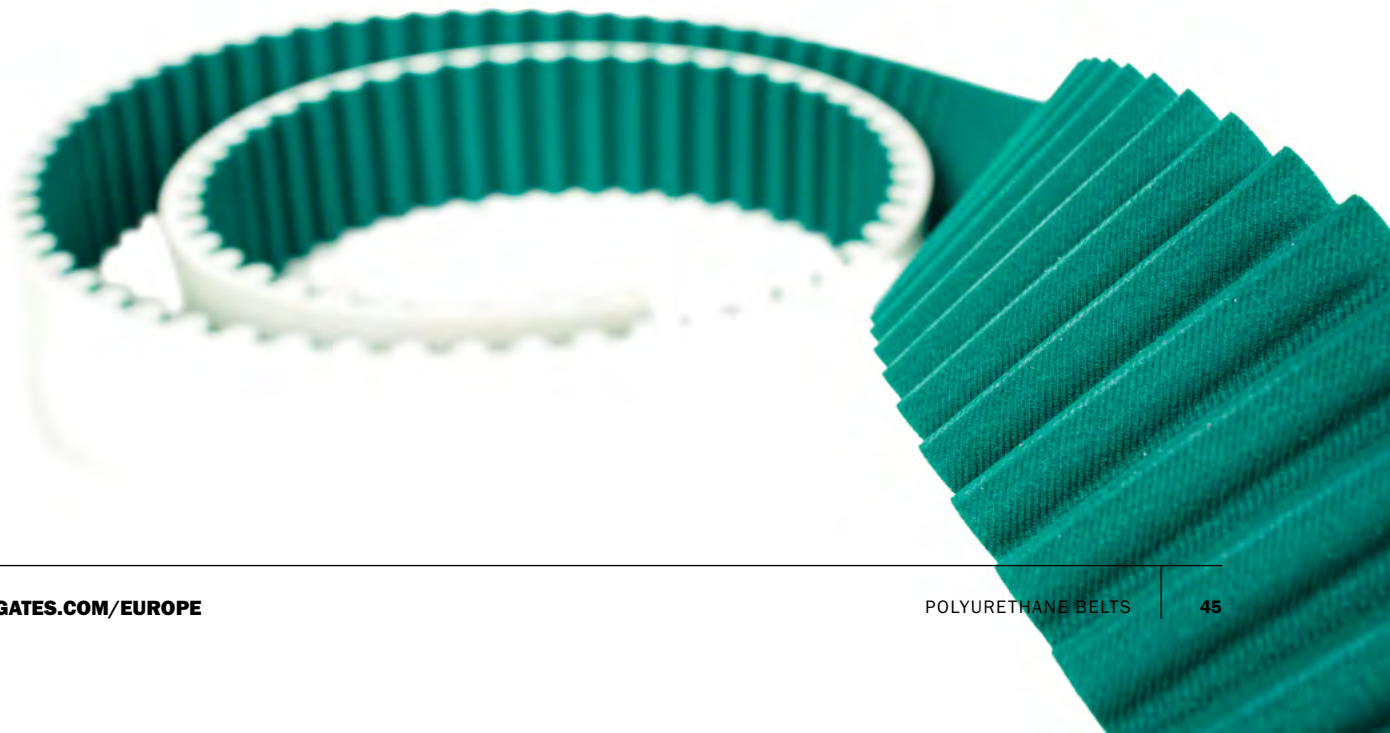



35 SYNCHRO-POWER WIDE

WIDE POLYURETHANE SYNCHRONOUS BELTS FOR CONVEYING APPLICATIONS

WIDE BELTS

Gates TPU Wide Belts are ideal for conveying applications that require greater than 150mm width, precise product positioning, and smooth-running operation. The high strength aramid cords ensure even tension characteristics. The high quality polyurethane is cut resistant and non-marking, making this belt ideal for abrasive environments.

Gates TPU wide belts offer an alternative to plastic modular and conveyor belting with our abrasion resistant, smooth drive wide belts.

ATTRIBUTES

- Cut resistant
- Widths up to 450 mm available
- Suitable for synchronous conveying applications
- No cord exposure at the edges of the belt
- Low-noise, smooth operation
- FDA and EU food approval for various pitches

APPLICATIONS

- Synchronous conveying applications
- Bulk conveying
- Food and confectionary conveying
- Hygienic applications

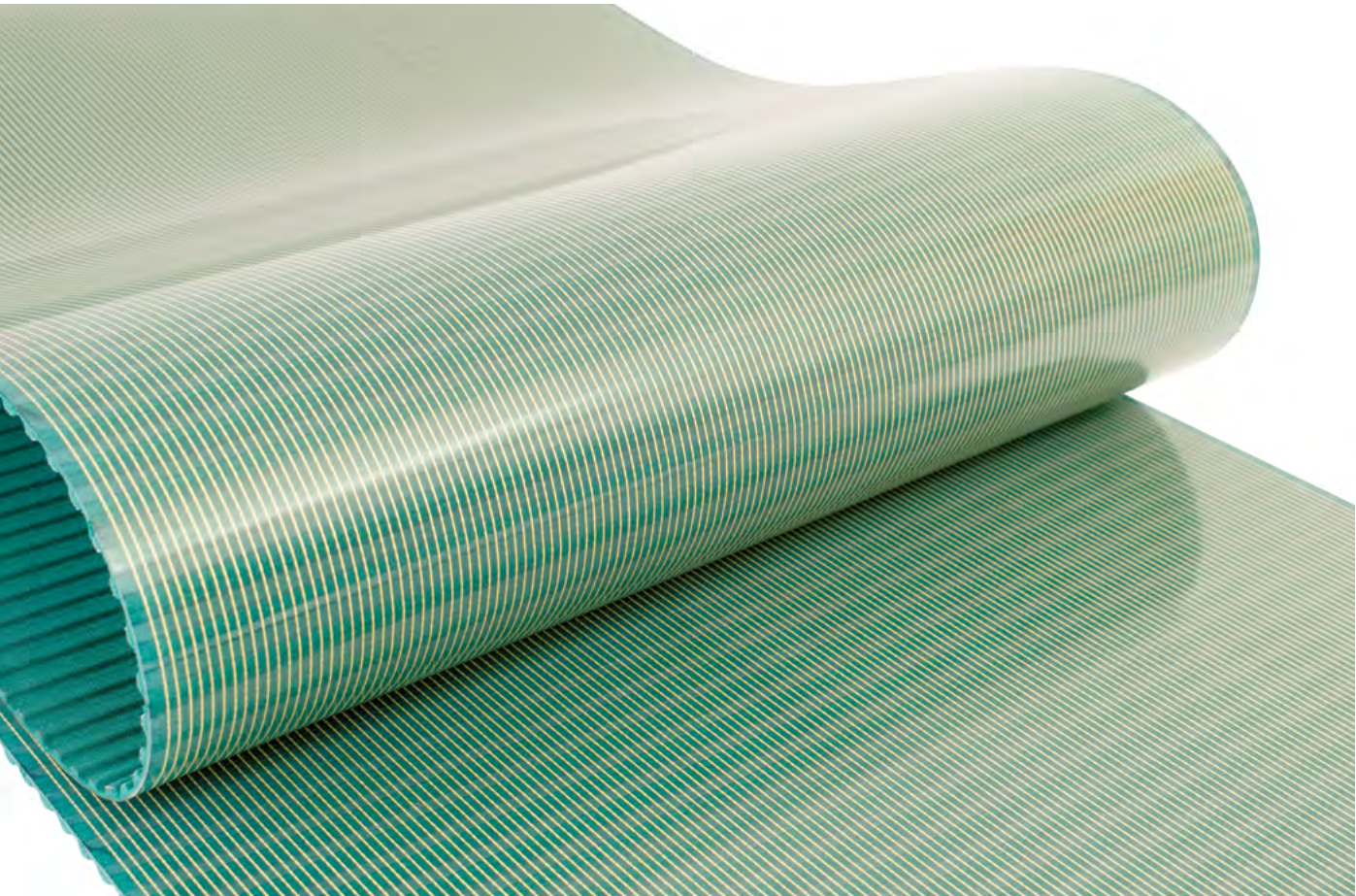



36 SYNCHRO-POWER FLAT

EXTRUDED, HIGH-STRENGTH BELTS FOR LIFTING AND CONVEYING APPLICATIONS

FLAT BELTS

Gates TPU flat belts made from high strength polyurethane are produced in standard rolls or open ended belts and are commonly used in lifting and pulling applications. Flat belts are typically attached at one or both ends with clamping plates or with our new FIX-FLAT clamping system

Our flat belts are suited for a wide range of mechanical requirements. We offer various combinations of polyurethane types and cords to support the diverse needs of the market.

Our latest development FIX-FLAT, the flat belt clamp, enables the secure clamping of any flat belts at both ends easily, quickly and safely.

FEATURES

- Smooth, vibration free operation
- High strength combined with low elongation
- Sealed belt edges result in no cord fraying
- Easy belt guide with flanged sprockets or guiding rails
- No re-tensioning required

TYPICAL APPLICATIONS:

- Heavy load lifting or lowering
- Exercise machines
- Applications with small sprocket diameters





4. METAL PARTS

37 SPROCKETS POLY CHAIN GT 8MGT - 14MGT

Poly Chain GT sprockets use the tooth profile designed and developed by Gates and function with Gates Poly Chain GT belts in all existing constructions. These sprockets are statically balanced to make sure the entire belt drive is as safe as possible. Furthermore, they are manufactured, specified and tested to perfectly support the full power capabilities of the Gates Poly Chain belt product range. Belts and sprockets used together get the best out of your belt drive: maximal performance, prolonged antistatic properties and optimal lifetime.



BENEFITS

- Precisely manufactured and statically balanced to ISO 1940 (1973) to class G16.
- Exact sprocket design produces positive, press fit to shaft.
- Smaller, narrower sprockets save shaft space, keep the load closer to the bearing and extend life of reducer.
- Keep overhung load below manufacturers recommendation.
- Specifically designed to transmit power only with the corresponding Gates Poly Chain belt product line.
- The tooth profile of the sprocket is designed and developed by Gates to operate with Gates Poly Chain GT Carbon VOLT; Poly Chain GT Carbon and Poly Chain GT2.

SPROCKET RANGE

8MGT	22 to 192 grooves Suited for standard belt widths of 12, 21, 36, 62mm
14MGT	28 to 192 grooves Suited for standard belt widths of 20, 37, 68, 90, 125 mm

ORDERING CODE

14M-28S-20

14M - Pitch 14mm

28S - Number of teeth

20 - suited for belt width (mm)

NOTE: For correct design and tensioning of the belt please consult with our application engineering team.

Identification

Durable "punched" markings indicating the sprocket dimensions.

PLEASE REFER TO P. 258 FOR SIZE LIST.



38 SPROCKETS POLY CHAIN 5MGT/POWERGRIP 5MGT

Poly Chain/PowerGrip GT sprockets are specially engineered and manufactured to work with PowerGrip GT3 and Poly Chain GT Carbon 5MGT belts, delivering maximum performance and superior reliability.

CONSTRUCTION

- Smaller diameter sprockets are flanged.
- Constructions are Pilot Bore or suit a taper bush.

BENEFITS

- Easy installation and removal due to full split in bushing design.
- Precise sprocket design produces positive, press fit to shaft.
- Precision manufactured and static balanced to eliminate sprocket wobble.
- Space-saving design results in more shaft space.
- Designed to keep the load closer to the bearing and extend reducer life.



SPROCKET RANGE	
Plain bore system	18 to 50 grooves Suited for standard belt widths of 9, 15, 25mm
Taperbush system	36 to 90 grooves Suited for standard belt widths of 9, 15, 25mm

ORDERING CODE
5M-36S-25 5M - Pitch 5mm 36S - number of teeth 25 - suited for belt width (mm)
5M-20S-25-PB 5M - Pitch 5mm 20S - number of teeth 25 - suited for belt width (mm) PB - Plain bore
PLEASE REFER TO P. 264 FOR SIZE LIST.



39 SPROCKETS POLY CHAIN GT STAINLESS STEEL 8MGT

Stainless steel Poly Chain GT sprockets are ideal for the food and beverage industry or where non-corrosive sprockets are needed to prevent rust and allow for washdown. Poly Chain GT sprockets operate with Gates Poly Chain Carbon VOLT belts and all previous constructions.

CONSTRUCTION

- Strong, durable sprockets designed for use with your Poly Chain GT2, Poly Chain GT or Poly Chain GT Carbon belts.



BENEFITS

- Cost effective alternative to stainless steel roller chain drives.
- Can be used with rim speeds up to 40m/s.
- Drive can be washed down without affecting the sprockets or belt.
- Poly Chain GT sprockets keep overhung load below manufacturers' recommendation.
- Precise sprocket design produces positive, press fit to shaft.
- Precision manufactured and static balanced.
- Re-work services have turnaround time.
- Smaller, narrower sprockets save shaft space, keep the load closer to bearing and extend life of reducer.
- Sprockets are precision manufactured and static balanced.

SPROCKET RANGE	
Taperbush system	28 to 50 grooves Suited for standard belt widths of 12, 21mm

ORDERING CODE
8M-28S-12SS
8M - Pitch 8mm
28S - Number of teeth
12 - suited for belt width (mm)
SS - Stainless Steel
PLEASE REFER TO P. 266 FOR SIZE LIST.



40 IDLER SPROCKETS POLY CHAIN GT 8MGT & 14MGT

Gates Idler Sprockets are ideal for use in chain drive conversions. They can be used to take-up extra belt length and provide adjustment for tensioning belt drives. Idler sprockets and sprockets can also be used to alter belt paths and navigate obstructions.

CONSTRUCTION

- Gates Idler Sprockets contain sealed ball bearings and an integral shaft for mounting to our adjustable idler brackets.

BENEFITS

- Range for Poly Chain GT Carbon VOLT belts.
- Lubrication and maintenance are not required.
- Ideal for belt drive customization.
- Maintenance-free operation.
- Includes: sprocket, sealed ball bearings, integral shaft.
- Adjustable idler brackets sold separately.



IDLER SPROCKET RANGE	
8MGT	32 grooves - suited for standard belt widths of 12, 21mm 36 grooves - suited for standard belt widths of 36, 62mm
14MGT	30 grooves - suited for standard belt width of 20, 37mm 34 grooves - suited for standard belt widths of 68, 90, 125mm

ORDERING CODE
IDLER-SPROCKET-8M-32S-21
IDLER-SPROCKET - grooved inside idler
8M - Pitch 8mm
32S - number of teeth
21 - suited for belt width (mm)
PLEASE REFER TO P. 267 FOR SIZE LIST.

41 IDLER BRACKETS

Belt drives with fixed, or limited adjustment, centre distances require an alternative way to tension it. Gates idler brackets can be used to tension a belt from the inside or backside using the appropriate attachments.

CONSTRUCTION

- Gates adjustable idler brackets are designed to be highly versatile, with two different means of adjustment.
- Adjustment can be made by pivoting the base flange about the bracket pivot point along the adjustment slot, or by pivoting the idler bracket arm on the base flange.

BENEFITS

- Double-adjustable (base and arm).
- Designed to accept Gates Idler Sprockets, Idler Bushings and Flat Idler Sprockets.
- Ideal for conveyor drives with fixed centre distances.
- Idler brackets are pre-programmed in Gates Design IQ™ drive design software.
- Lubrication and maintenance are not required.



ORDERING CODE

Comes in 2 versions:
BRACKET 10 and **BRACKET 20**

PLEASE REFER TO P. 268 FOR SIZE LIST.



42 FLAT IDLER SPROCKETS

Idlers can be used to take up extra belt length and provide adjustment for tensioning belt drives. Idler sprockets and sprockets can alter belt paths and clear obstructions.

CONSTRUCTION

- Flat Idler Sprockets contain sealed ball bearings and an integral shaft for mounting to our adjustable idler brackets.

BENEFITS

- Lubrication and maintenance are not required.
- Suitable for a range of synchronous and V-belts.



FLAT IDLER SPROCKETS RANGE

Diameter: 108mm/4.25"	Available in sprocket width of 32, 51, 76, 102mm Suited for 8M pitch synchronous belts
Diameter: 165mm/6.50"	Available in sprocket width of 44, 70, 108, 146, 190mm Suited for 14M pitch synchronous belts

ORDERING CODE

IDLER-FLAT-6.50x1.75
IDLER-FLAT - flat outside inside idler
6.5 - outside diameter 6.5" / 165mm
1.75 - sprocket width 1.75" / 44mm

PLEASE REFER TO P. 269 FOR SIZE LIST.



5. PREVENTIVE MAINTENANCE TOOLS

43 V-BELT SPROCKET GAUGES

Helps to identify worn V-belt sheaves and damaged V-belts. Gates colour coded V-belt and sprocket gauges provide a simple solution for detecting worn sprockets and identifying V-belt cross sections. The sprocket wear gauges fit standard industrial grooves, identifying excessive wear before it leads to premature belt failure.



ORDERING CODE

PN 7401-10002



44 INDUSTRIAL BELT LENGTH FINDER

The length measuring instrument can be used for V-belt, Micro-V and timing belts. The inside length can be measured in a range from 600mm to 4100mm. Gates belt measurer can be mounted on your wall to easily find the inside length of a V-belt. When used in conjunction with our belt and sprocket gauges belt identification is simple.

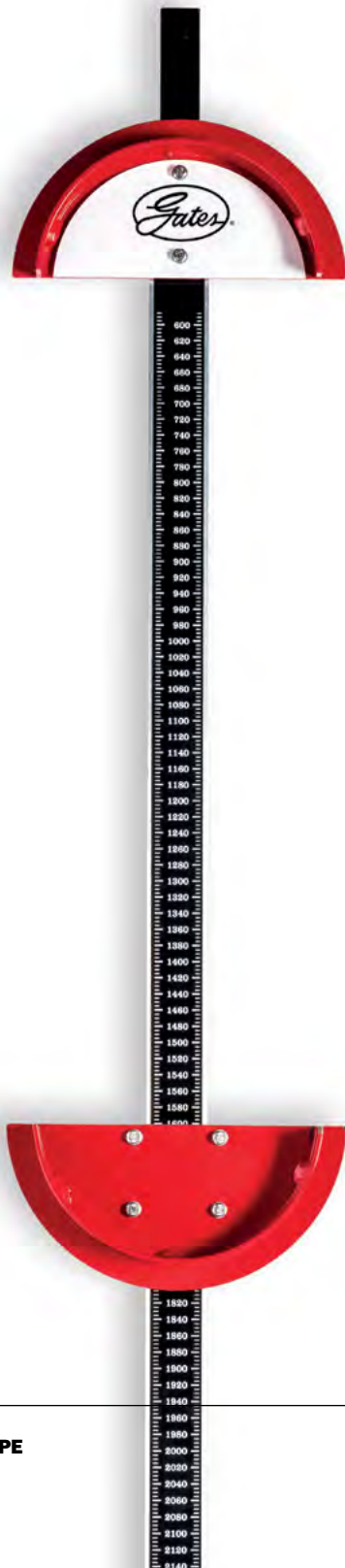
**ORDERING CODE**

PN 7401-10001

45 SINGLE / DOUBLE BARREL TENSION TESTER

Gates has two deflection tension testing tools for servicing of belt drives. The single barrel (15kg) and the double barrel (30kg) tester can be used to accurately measure the tension of individual or joined belts upon installation or during maintenance. Using the tension tester ensures that correct tension is maintained and is repeatable. This will yield not only a longer service life but a predictable one, enabling scheduled replacement rather than breakdown replacement.



ORDERING CODE

Single Barrel Tension tester:
PN 7401-00076

Double Barrel Tension tester:
PN 7401-00075

46 SONIC TENSION METER 550C

Correct belt installation tension is essential for optimum performance and reliability of multi-ribbed, V-belt and synchronous belt drives. The 508C sonic tension meter ensures simple and extremely accurate tension measurement by analysing sound waves from the belt through the sensor. It processes the input signals and displays the accurate tension measurement digitally. Gates' tension meter is user-friendly: it is compact, computerised and stores data for repetitive use. Gates' sonic tension meter measures belt tension accurately every time. It is supplied with a handy instruction manual.

TECHNICAL CHARACTERISTICS

- Suitable for multi-ribbed belts, V-belts and synchronous belts.
- CE approved.
- RoHS 2 complaint: the device complies with the European Directive (2002/95/EC) on the restriction of the use of certain hazardous substances in electrical and electronic equipment.
- Batteries: 2 x AAA.
- Measurement range: 10 Hz to 5,000 Hz.
- Measured accuracy: $\pm 1\%$.
- LCD screen backlight.
- Double display possible (Newton and/or Hz).
- New sensor type: flexible flat (standard included - PN 7420-00205).
- Stores weight, width and span constants for up to forty different drive systems.
- Auto gain adjustment function automatically eliminates background noise.
- Cord sensor and inductive sensor available on request.
- Compact model (H 160mm x D 26mm x W 59mm).
- Use and storage temperature range: -10°C to $+50^{\circ}\text{C}$ (free from condensation).

OPTIONAL ACCESSORIES

- CORD SENSOR (PN 7420-00206)
The cord sensor is recommended for measuring tensions at a distance from the tension meter.
- INDUCTIVE SENSOR (PN 7420-00212)
The inductive sensor is recommended for measurement particularly in noisy or windy environments. A steel clip to the back of the belt is required to measure the vibration frequency.
- PACKAGE OFFERING (PN 7420-10550)
Sonic 508C + Inductive sensor + Magnets.



ORDERING CODE

PN 7420-00550

IMPORTANT NOTE! GATES SONIC TENSION METER SHOULD NOT BE USED IN EXPLOSIVE RISK AREAS.

47 SONIC TENSION METER 350C

The correct tension of a belt in a drive – whether it's a V-belt, a V-ribbed belt or a synchronous belt – is crucial. Looking for a tension measuring device that is easy to handle and extremely accurate? Use the Gates Sonic tension meter 350C. This hand-held device delivers an accurate tension reading within seconds by analyzing sound waves caused by strumming the belt. Compatible with V-belts, V-ribbed belts, and synchronous belts, the 350C offers three frequency ranges and a measuring accuracy of +/- 1%. Belt pretension data can be determined by using Gates Design Power drive design software.

TECHNICAL CHARACTERISTICS

- Suited for multi-ribbed, V- and synchronous belts
- Measuring accuracy: +/- 1%
- Auto shutdown after 5 min. of inactivity
- Noise canceling microphone for improved accuracy
- Compact model: 120 mm x 27 mm x 75 mm (H x D x W)
- OLED screen with optimized resolution
- Frequency ranges: LOW (10-50 Hz), STANDARD (10-1000 Hz), HIGH (900-5000 Hz)
- Each standard package includes a meter with attached microphone and 2 AAA batteries
- Use and storage temperature range: -20 °C to +70 °C (free from condensation)



ORDERING CODE

PN 7420-00350

IMPORTANT NOTE: GATES SONIC TENSION METER SHOULD NOT BE USED IN EXPLOSIVE RISK AREAS.

48 LASER AT-1

A fast and accurate method to measure misalignment is offered by Gates' unique laser alignment device, **LASER AT-1**. Mounted in a few seconds, the laser line projected onto the targets allows you to quickly ascertain and correct misalignment. It identifies parallel as well as angular misalignment between the sprockets and is suitable for sprocket diameters of 60mm and larger. It can be used on both horizontally and vertically mounted machines.

TECHNICAL CHARACTERISTICS

- Suitable for multi-ribbed belts, V-belts and synchronous belts.
- CE approved.
- RoHS 2 compliant: the device complies with the European Directive (2002/95/EC) on the restriction of the use of certain hazardous substances in electrical and electronic equipment.
- Sprocket diameters: ≥ 60 mm.
- Laser class 2.
- Temperature range: -10°C up to $+50^{\circ}\text{C}$.
- Targets: 2 pieces magnet targets with adjustable centre line.
- 1 Battery: R6 (AA) 1.5 V



ORDERING CODE

AT1+2 targets: **PN 7401-10010**
Target: **PN 7401-10012**

IMPORTANT NOTE: GATES SONIC TENSION METER SHOULD NOT BE USED IN EXPLOSIVE RISK AREAS.

49 BELT INSTALLATION AND ROTATION DEVICE

INSTALLATION SECURITY WITH GATES BIRD™

The Gates Belt Installation + Rotation Device (BIRD) reduces finger and hand injuries during the installation or routine maintenance of a belt drive, by limiting the exposure of hands getting caught in pinch points. While a drive is shut down and locked out, the BIRD safely facilitates a rotational inspection of the drive.

Product No. 7420-1001

ORDERING CODE
PN 7420-01001





6. V-BELTS SIZE LIST



01 PREDATOR SPBP/5VP

DESCRIPTION	PRODUCT NUMBER	DATUM LENGTH (MM)	EFFECTIVE LENGTH (INCH)	WEIGHT (KG)
SPBP1400	9190-01400	1400		0.306
SPBP1450	9190-01450	1450		0.306
SPBP1500	9190-01500	1500		0.330
SPBP1550	9190-01550	1550		0.339
SPBP1600/5VP630	9190-01600	1600	63	0.350
SPBP1650	9190-01650	1650		0.361
SPBP1700/5VP670	9190-01700	1700	67	0.370
SPBP1750	9190-01750	1750		0.383
SPBP1800/5VP710	9190-01800	1800	71	0.390
SPBP1850	9190-01850	1850		0.404
SPBP1900/5VP750	9190-01900	1900	75	0.420
SPBP1950	9190-01950	1950		0.426
SPBP2000	9190-02000	2000		0.440
SPBP2060	9190-02060	2060		0.450
SPBP2120	9190-02120	2120		0.470
SPBP2150	9190-02150	2160		0.470
SPBP2240	9190-02240	2240		0.500
SPBP2360	9190-02360	2360		0.520
SPBP2400	9190-02400	2400		0.525
SPBP2500	9190-02500	2500		0.560
SPBP2650	9190-02650	2650		0.590
SPBP2680	9190-02680	2680		0.586
SPBP2800	9190-02800	2800		0.620
SPBP2850	9190-02850	2850		0.623
SPBP2900	9190-02900	2900		0.634
SPBP3000/5VP1180	9190-03000	3000	118	0.670
SPBP3150/5VP1250	9190-03150	3150	125	0.700
SPBP3250	9190-03250	3250		0.710
SPBP3350/5VP1320	9190-03350	3350	132	0.740
SPBP3550/5VP1400	9190-03550	3550	140	0.790
SPBP3650	9190-03650	3650		0.798
SPBP3750/5VP1500	9190-03750	3750	150	0.830
SPBP3800	9190-03800	3800		0.831
SPBP4000/5VP1600	9190-04000	4000	160	0.890
SPBP4250/5VP1700	9190-04250	4250	170	0.950
SPBP4500/5VP1800	9190-04500	4500	180	1.000
SPBP4750	9190-04750	4750		1.060
SPBP5000/5VP2000	9190-05000	5000	200	1.160
SPBP5300	9190-05300	5300		1.230
SPBP5600	9190-05600	5600		1.250
SPBP6000/5VP2360	9190-06000	6000	236	1.340
SPBP6300/5VP2500	9190-06300	6300	250	1.400
SPBP6700/5VP2650	9190-06700	6700	265	1.490
SPBP7100/5VP2800	9190-07100	7100	280	1.580
SPBP7500	9190-07500	7500		1.670
SPBP8000/5VP3150	9190-08000	8000	315	1.780

* THE ITEM IS MADE-TO-ORDER, NOT IN STOCK. PLEASE REFER TO GATES E-COMMERCE WEBSITE FOR UPDATED INFORMATION



02 PREDATOR SPCP

DESCRIPTION	PRODUCT NUMBER	DATUM LENGTH (MM)	WEIGHT (KG)
SPCP2000	9191-02000	2000	0.810
SPCP2120	9191-02120	2120	0.860
SPCP2240	9191-02240	2240	0.900
SPCP2360	9191-02360	2360	0.950
SPCP2500	9191-02500	2500	1.010
SPCP2650	9191-02650	2650	1.070
SPCP2800	9191-02800	2800	1.130
SPCP3000	9191-03000	3000	1.210
SPCP3150	9191-03150	3150	1.290
SPCP3350	9191-03350	3350	1.370
SPCP3550	9191-03550	3550	1.450
SPCP3750	9191-03750	3750	1.530
SPCP4000	9191-04000	4000	1.630
SPCP4250	9191-04250	4250	1.740
SPCP4500	9191-04500	4500	1.840
SPCP4750	9191-04750	4750	1.940
SPCP5000	9191-05000	5000	2.040
SPCP5300	9191-05300	5300	2.170
SPCP5600	9191-05600	5600	2.290
SPCP6000	9191-06000	6000	2.450
SPCP6300	9191-06300	6300	2.580
SPCP6700	9191-06700	6700	2.740
SPCP7100	9191-07100	7100	2.910
SPCP7500	9191-07500	7500	3.070
SPCP8000	9191-08000	8000	3.270
SPCP8500	9191-08500	8500	3.480
SPCP9000	9191-09000	9000	3.680
SPCP9500	9191-09500	9500	3.890
SPCP10000	9191-10000	10000	4.100
SPCP10600	9191-10600*	10600	4.340

* THE ITEM IS MADE-TO-ORDER, NOT IN STOCK. PLEASE REFER TO GATES E-COMMERCE WEBSITE FOR UPDATED INFORMATION



03 PREDATOR 8VP

DESCRIPTION	PRODUCT NUMBER	DATUM LENGTH (MM)	EFFECTIVE LENGTH (INCH)	WEIGHT (KG)
8VP1600	9189-00160	4064	160	2.320
8VP1700	9189-00170	4318	170	2.500
8VP1800	9189-00180	4572	180	2.680
8VP1900	9189-00190	4826	190	2.870
8VP2000	9189-00200	5080	200	3.050
8VP2120	9189-00212	5385	212	3.270
8VP2240	9189-00224	5690	224	3.500
8VP2360	9189-00236	5994	236	3.720
8VP2500	9189-00250	6350	250	3.980
8VP2650	9189-00265	6731	265	4.250
8VP2800	9189-00280	7112	280	4.530
8VP3000	9189-00300	7620	300	4.900
8VP3150	9189-00315	8001	315	5.175
8VP3350	9189-00335	8509	335	5.550
8VP3550	9189-00355	9017	355	5.920

04 QUAD-POWER 4 XPZ-3VX

DESCRIPTION	PRODUCT NUMBER	DATUM LENGTH (MM)	EFFECTIVE LENGTH (INCH)	WEIGHT (KG)
XPZ562/3VX223	9643-00562	562	22.3	0.032
XPZ587/3VX233	9643-00587	587	23.3	0.034
XPZ600/3VX238	9643-00600	600	23.8	0.034
XPZ612/3VX243	9643-00612	612	24.3	0.035
XPZ630/3VX250	9643-00630	630	25.0	0.036
XPZ637/3VX252	9643-00637	637	25.2	0.036
XPZ660/3VX261	9643-00660	660	26.1	0.038
XPZ662/3VX262	9643-00662	662	26.2	0.038
XPZ670/3VX265	9643-00670	670	26.5	0.038
XPZ687/3VX272	9643-00687	687	27.2	0.040
XPZ710/3VX280	9643-00710	710	28.0	0.041
XPZ722/3VX286	9643-00722	722	28.6	0.042
XPZ730/3VX289	9643-00730	730	28.9	0.042
XPZ737/3VX292	9643-00737	737	29.2	0.042
XPZ750/3VX297	9643-00750	750	29.7	0.043
XPZ762/3VX300	9643-00762	762	30.0	0.044
XPZ772/3VX305	9643-00772	772	30.5	0.044
XPZ775/3VX307	9643-00775	775	30.7	0.044
XPZ787/3VX311	9643-00787	787	31.1	0.045
XPZ800/3VX315	9643-00800	800	31.5	0.046
XPZ812/3VX321	9643-00812	812	32.1	0.047
XPZ817/3VX323	9643-00817	817	32.3	0.047
XPZ825/3VX325	9643-00825	825	32.5	0.048
XPZ837/3VX331	9643-00837	837	33.1	0.048

* THE ITEM IS MADE-TO-ORDER, NOT IN STOCK. PLEASE REFER TO GATES E-COMMERCE WEBSITE FOR UPDATED INFORMATION

PREDATOR

QUAD POWER



04 QUAD-POWER 4 XPZ-3VX

DESCRIPTION	PRODUCT NUMBER	DATUM LENGTH (MM)	EFFECTIVE LENGTH (INCH)	WEIGHT (KG)
XPZ850/3VX335	9643-00850	850	33.5	0.049
XPZ862/3VX341	9643-00862	862	34.1	0.050
XPZ875/3VX346	9643-00875	875	34.6	0.050
XPZ887/3VX350	9643-00887	887	35.0	0.051
XPZ900/3VX355	9643-00900	900	35.5	0.052
XPZ912/3VX360	9643-00912	912	36.0	0.053
XPZ917/3VX362	9643-00917	917	36.2	0.053
XPZ925/3VX366	9643-00925	925	36.6	0.053
XPZ937/3VX370	9643-00937	937	37.0	0.054
XPZ950/3VX375	9643-00950	950	37.5	0.055
XPZ962/3VX380	9643-00962	962	38.0	0.056
XPZ975/3VX385	9643-00975	975	38.5	0.056
XPZ980/3VX387	9643-00980	980	38.7	0.057
XPZ987/3VX390	9643-00987	987	39.0	0.057
XPZ1000/3VX395	9643-01000	1000	39.5	0.058
XPZ1012/3VX400	9643-01012	1012	40.0	0.059
XPZ1025/3VX405	9643-01025	1025	40.5	0.060
XPZ1030/3VX407	9643-01030	1030	40.7	0.060
XPZ1037/3VX410	9643-01037	1037	41.0	0.060
XPZ1047/3VX414	9643-01047	1047	41.4	0.061
XPZ1060/3VX420	9643-01060	1060	42.0	0.061
XPZ1077/3VX425	9643-01077	1077	42.5	0.062
XPZ1080/3VX426	9643-01080	1080	42.6	0.063
XPZ1087/3VX429	9643-01087	1087	42.9	0.063
XPZ1110/3VX438	9643-01110	1110	43.8	0.064
XPZ1112/3VX439	9643-01112	1112	43.9	0.064
XPZ1120/3VX442	9643-01120	1120	44.2	0.065
XPZ1137/3VX450	9643-01137	1137	45.0	0.066
XPZ1140/3VX450	9643-01140	1140	45.0	0.066
XPZ1150/3VX454	9643-01150	1150	45.4	0.067
XPZ1162/3VX459	9643-01162	1162	45.9	0.067
XPZ1180/3VX464	9643-01180	1180	46.4	0.068
XPZ1187/3VX469	9643-01187	1187	46.9	0.069
XPZ1202/3VX475	9643-01202	1202	47.5	0.070
XPZ1212/3VX479	9643-01212	1212	47.9	0.070
XPZ1220/3VX482	9643-01220	1220	48.2	0.070
XPZ1237/3VX487	9643-01237	1237	48.7	0.072
XPZ1250/3VX494	9643-01250	1250	49.4	0.072
XPZ1262/3VX500	9643-01262	1262	50.0	0.073
XPZ1270/3VX502	9643-01270	1270	50.2	0.074
XPZ1280/3VX505	9643-01280	1280	50.5	0.074
XPZ1287/3VX508	9643-01287	1287	50.8	0.075
XPZ1312/3VX518	9643-01312	1312	51.8	0.076
XPZ1320/3VX520	9643-01320	1320	52.0	0.076
XPZ1337/3VX530	9643-01337	1337	53.0	0.077
XPZ1347/3VX532	9643-01347	1347	53.2	0.078
XPZ1360/3VX537	9643-01360	1360	53.7	0.079

* THE ITEM IS MADE-TO-ORDER, NOT IN STOCK. PLEASE REFER TO GATES E-COMMERCE WEBSITE FOR UPDATED INFORMATION



04 QUAD-POWER 4 XPZ-3VX

DESCRIPTION	PRODUCT NUMBER	DATUM LENGTH (MM)	EFFECTIVE LENGTH (INCH)	WEIGHT (KG)
XPZ1362/3VX538	9643-01362	1362	53.8	0.079
XPZ1387/3VX548	9643-01387	1387	54.8	0.081
XPZ1400/3VX553	9643-01400	1400	55.3	0.081
XPZ1412/3VX560	9643-01412	1412	56.0	0.082
XPZ1420/3VX563	9643-01420	1420	56.3	0.082
XPZ1437/3VX567	9643-01437	1437	56.7	0.083
XPZ1450/3VX572	9643-01450	1450	57.2	0.084
XPZ1462/3VX578	9643-01462	1462	57.8	0.085
XPZ1487/3VX587	9643-01487	1487	58.7	0.086
XPZ1500/3VX590	9643-01500	1500	59.0	0.087
XPZ1512/3VX600	9643-01512	1512	60.0	0.088
XPZ1520/3VX603	9643-01520	1520	60.3	0.088
XPZ1537/3VX607	9643-01537	1537	60.7	0.089
XPZ1550/3VX612	9643-01550	1550	61.2	0.090
XPZ1562/3VX617	9643-01562	1562	61.7	0.092
XPZ1587/3VX626	9643-01587	1587	62.6	0.092
XPZ1600/3VX630	9643-01600	1600	63.0	0.093
XPZ1612/3VX637	9643-01612	1612	63.7	0.094
XPZ1637/3VX646	9643-01637	1637	64.6	0.095
XPZ1650/3VX650	9643-01650	1650	65.0	0.096
XPZ1662/3VX656	9643-01662	1662	65.6	0.097
XPZ1687/3VX666	9643-01687	1687	66.6	0.098
XPZ1700/3VX670	9643-01700	1700	67.0	0.099
XPZ1737/3VX686	9643-01737	1737	68.6	0.101
XPZ1750/3VX690	9643-01750	1750	69.0	0.102
XPZ1762/3VX696	9643-01762	1762	69.6	0.102
XPZ1787/3VX705	9643-01787	1787	70.5	0.104
XPZ1800/3VX710	9643-01800	1800	71.0	0.105
XPZ1812/3VX715	9643-01812	1812	71.5	0.105
XPZ1837/3VX725	9643-01837	1837	72.5	0.095
XPZ1850/3VX730	9643-01850	1850	73.0	0.096
XPZ1862/3VX735	9643-01862	1862	73.5	0.097
XPZ1887/3VX745	9643-01887	1887	74.5	0.097
XPZ1900/3VX750	9643-01900	1900	75.0	0.098
XPZ1937/3VX765	9643-01937	1937	76.5	0.100
XPZ1950/3VX771	9643-01950	1950	77.1	0.101
XPZ1987/3VX784	9643-01987	1987	78.4	0.103
XPZ2000/3VX790	9643-02000	2000	79.0	0.104
XPZ2030/3VX800	9643-02030	2030	80.0	0.105
XPZ2037/3VX804	9643-02037	2037	80.4	0.126
XPZ2060/3VX813	9643-02060	2060	81.3	0.128
XPZ2120/3VX836	9643-02120	2120	83.6	0.110
XPZ2137/3VX843	9643-02137	2137	84.3	0.110
XPZ2160/3VX850	9643-02160	2160	85.0	0.112
XPZ2187/3VX863	9643-02187	2187	86.3	0.113
XPZ2240/3VX883	9643-02240	2240	88.3	0.116
XPZ2262/3VX892	9643-02262	2262	89.2	0.117

* THE ITEM IS MADE-TO-ORDER, NOT IN STOCK. PLEASE REFER TO GATES E-COMMERCE WEBSITE FOR UPDATED INFORMATION



04 QUAD-POWER 4 XPZ-3VX

DESCRIPTION	PRODUCT NUMBER	DATUM LENGTH (MM)	EFFECTIVE LENGTH (INCH)	WEIGHT (KG)
XPZ2280/3VX900	9643-02280	2280	90.0	0.118
XPZ2287/3VX902	9643-02287	2287	90.2	0.118
XPZ2360/3VX931	9643-02360	2360	93.1	0.123
XPZ2410/3VX950	9643-02410	2410	95.0	0.125
XPZ2430/3VX959	9643-02430	2430	95.9	0.125
XPZ2500/3VX986	9643-02500	2500	98.6	0.130
XPZ2540/3VX1000	9643-02540	2540	100.0	0.132
XPZ2650/3VX1045	9643-02650	2650	104.5	0.138
XPZ2690/3VX1060	9643-02690	2690	106.0	0.139
XPZ2800/3VX1104	9643-02800	2800	110.4	0.145
XPZ2840/3VX1120	9643-02840	2840	112.0	0.148
XPZ3000/3VX1180	9643-03000	3000	118.0	0.156
XPZ3150/3VX1242	9643-03150	3150	124.2	0.164
XPZ3350/3VX1320	9643-03350	3350	132.0	0.174
XPZ3550/3VX1400	9643-03550	3550	140.0	0.184

05 QUAD-POWER 4 XPA

DESCRIPTION	PRODUCT NUMBER	DATUM LENGTH (MM)	WEIGHT (KG)
XPA690	9644-00690	690	0.061
XPA732	9644-00732	732	0.065
XPA747	9644-00747	747	0.056
XPA750	9644-00750	750	0.066
XPA757	9644-00757	757	0.067
XPA775	9644-00775	775	0.069
XPA782	9644-00782	782	0.069
XPA800	9644-00800	800	0.071
XPA807	9644-00807	807	0.072
XPA825	9644-00825	825	0.073
XPA832	9644-00832	832	0.074
XPA850	9644-00850	850	0.076
XPA857	9644-00857	857	0.076
XPA875	9644-00875	875	0.090
XPA882	9644-00882	882	0.078
XPA900	9644-00900	900	0.080
XPA907	9644-00907	907	0.081
XPA925	9644-00925	925	0.082
XPA932	9644-00932	932	0.083
XPA950	9644-00950	950	0.085
XPA957	9644-00957	957	0.085
XPA975	9644-00975	975	0.087
XPA982	9644-00982	982	0.087
XPA1000	9644-01000	1000	0.089
XPA1007	9644-01007	1007	0.090

* THE ITEM IS MADE-TO-ORDER, NOT IN STOCK. PLEASE REFER TO GATES E-COMMERCE WEBSITE FOR UPDATED INFORMATION



05 QUAD-POWER 4 XPA

DESCRIPTION	PRODUCT NUMBER	DATUM LENGTH (MM)	WEIGHT (KG)
XPA1030	9644-01030	1030	0.092
XPA1060	9644-01060	1060	0.095
XPA1069	9644-01069	1069	0.096
XPA1082	9644-01082	1082	0.097
XPA1090	9644-01090	1090	0.097
XPA1107	9644-01107	1107	0.099
XPA1120	9644-01120	1120	0.100
XPA1132	9644-01132	1132	0.104
XPA1140	9644-01140	1140	0.102
XPA1142	9644-01142	1142	0.102
XPA1150	9644-01150	1150	0.103
XPA1157	9644-01157	1157	0.103
XPA1172	9644-01172	1172	0.109
XPA1180	9644-01180	1180	0.106
XPA1207	9644-01207	1207	0.108
XPA1215	9644-01215	1215	0.109
XPA1220	9644-01220	1220	0.109
XPA1232	9644-01232	1232	0.110
XPA1250	9644-01250	1250	0.112
XPA1257	9644-01257	1257	0.112
XPA1272	9644-01272	1272	0.116
XPA1282	9644-01282	1282	0.115
XPA1285	9644-01285	1285	0.115
XPA1307	9644-01307	1307	0.117
XPA1320	9644-01320	1320	0.119
XPA1332	9644-01332	1332	0.120
XPA1357	9644-01357	1357	0.122
XPA1360	9644-01360	1360	0.122
XPA1367	9644-01367	1367	0.123
XPA1382	9644-01382	1382	0.124
XPA1400	9644-01400	1400	0.126
XPA1407	9644-01407	1407	0.127
XPA1432	9644-01432	1432	0.129
XPA1442	9644-01442	1442	0.130
XPA1450	9644-01450	1450	0.130
XPA1457	9644-01457	1457	0.131
XPA1462	9644-01462	1462	0.131
XPA1482	9644-01482	1482	0.133
XPA1500	9644-01500	1500	0.135
XPA1507	9644-01507	1507	0.136
XPA1522	9644-01522	1522	0.137
XPA1532	9644-01532	1532	0.138
XPA1550	9644-01550	1550	0.139
XPA1557	9644-01557	1557	0.140
XPA1582	9644-01582	1582	0.142
XPA1600	9644-01600	1600	0.144
XPA1607	9644-01607	1607	0.160
XPA1632	9644-01632	1632	0.147
XPA1650	9644-01650	1650	0.149

* THE ITEM IS MADE-TO-ORDER, NOT IN STOCK. PLEASE REFER TO GATES E-COMMERCE WEBSITE FOR UPDATED INFORMATION



05 QUAD-POWER 4 XPA

DESCRIPTION	PRODUCT NUMBER	DATUM LENGTH (MM)	WEIGHT (KG)
XPA1657	9644-01657	1657	0.149
XPA1680	9644-01680	1680	0.151
XPA1682	9644-01682	1682	0.151
XPA1700	9644-01700	1700	0.153
XPA1707	9644-01707	1707	0.154
XPA1732	9644-01732	1732	0.156
XPA1750	9644-01750	1750	0.158
XPA1757	9644-01757	1757	0.140
XPA1782	9644-01782	1782	0.161
XPA1800	9644-01800	1800	0.162
XPA1807	9644-01807	1807	0.163
XPA1832	9644-01832	1832	0.178
XPA1850	9644-01850	1850	0.149
XPA1857	9644-01857	1857	0.170
XPA1882	9644-01882	1882	0.184
XPA1900	9644-01900	1900	0.153
XPA1907	9644-01907	1907	0.153
XPA1932	9644-01932	1932	0.155
XPA1950	9644-01950	1950	0.158
XPA1957	9644-01957	1957	0.158
XPA1982	9644-01982	1982	0.160
XPA2000	9644-02000	2000	0.161
XPA2032	9644-02032	2032	0.164
XPA2057	9644-02057	2057	0.167
XPA2060	9644-02060	2060	0.167
XPA2082	9644-02082	2082	0.210
XPA2120	9644-02120	2120	0.170
XPA2132	9644-02132	2132	0.170
XPA2180	9644-02180	2180	0.176
XPA2207	9644-02207	2207	0.210
XPA2232	9644-02232	2232	0.218
XPA2240	9644-02240	2240	0.181
XPA2282	9644-02282	2282	0.184
XPA2300	9644-02300	2300	0.185
XPA2307	9644-02307	2307	0.218
XPA2332	9644-02332	2332	0.224
XPA2360	9644-02360	2360	0.190
XPA2382	9644-02382	2382	0.191
XPA2430	9644-02430	2430	0.196
XPA2482	9644-02482	2482	0.340
XPA2500	9644-02500	2500	0.202
XPA2532	9644-02532	2532	0.240
XPA2582	9644-02582	2582	0.208
XPA2607	9644-02607	2607	0.250
XPA2632	9644-02632	2632	0.215
XPA2650	9644-02650	2650	0.215
XPA2682	9644-02682	2682	0.217
XPA2732	9644-02732	2732	0.219
XPA2782	9644-02782	2782	0.227

* THE ITEM IS MADE-TO-ORDER, NOT IN STOCK. PLEASE REFER TO GATES E-COMMERCE WEBSITE FOR UPDATED INFORMATION



05 QUAD-POWER 4 XPA

DESCRIPTION	PRODUCT NUMBER	DATUM LENGTH (MM)	WEIGHT (KG)
XPA2800	9644-02800	2800	0.227
XPA2832	9644-02832	2832	0.270
XPA2847	9644-02847	2847	0.230
XPA2882	9644-02882	2882	0.235
XPA2900	9644-02900	2900	0.235
XPA2932	9644-02932	2932	0.239
XPA2982	9644-02982	2982	0.243
XPA3000	9644-03000	3000	0.243
XPA3150	9644-03150	3150	0.255
XPA3350	9644-03350	3350	0.271
XPA3550	9644-03550	3550	0.287
XPA3750	9644-03750	3750	0.304
XPA4000	9644-04000	4000	0.324

06 QUAD-POWER 4 XPB-5VX

DESCRIPTION	PRODUCT NUMBER	DATUM LENGTH (MM)	EFFECTIVE LENGTH (INCH)	WEIGHT (KG)
XPB1000/5VX398	9645-01000	1000	39.8	0.143
XPB1060/5VX422	9645-01060	1060	42.2	0.152
XPB1080/5VX430	9645-01080	1080	43	0.155
XPB1120/5VX445	9645-01120	1120	44.5	0.161
XPB1180/5VX470	9645-01180	1180	47	0.169
XPB1250/5VX497	9645-01250	1250	49.7	0.179
XPB1260/5VX500	9645-01260	1260	50	0.181
XPB1280/5VX510	9645-01280	1280	51	0.184
XPB1320/5VX524	9645-01320	1320	52.4	0.190
XPB1340/5VX530	9645-01340	1340	53	0.193
XPB1400/5VX556	9645-01400	1400	55.6	0.201
XPB1410/5VX560	9645-01410	1410	56	0.203
XPB1450/5VX575	9645-01450	1450	57.5	0.208
XPB1500/5VX595	9645-01500	1500	59.5	0.216
XPB1510/5VX600	9645-01510	1510	60	0.217
XPB1550/5VX615	9645-01550	1550	61.5	0.223
XPB1590/5VX630	9645-01590	1590	63	0.229
XPB1600/5VX634	9645-01600	1600	63.4	0.230
XPB1650/5VX654	9645-01650	1650	65.4	0.237
XPB1690/5VX670	9645-01690	1690	67	0.244
XPB1700/5VX674	9645-01700	1700	67.4	0.245
XPB1750/5VX693	9645-01750	1750	69.3	0.252
XPB1800/5VX713	9645-01800	1800	71.3	0.259
XPB1850/5VX733	9645-01850	1850	73.3	0.238
XPB1900/5VX750	9645-01900	1900	75	0.245
XPB1950/5VX772	9645-01950	1950	77.2	0.251
XPB2000/5VX790	9645-02000	2000	79	0.258
XPB2020/5VX800	9645-02020	2020	80	0.261

* THE ITEM IS MADE-TO-ORDER, NOT IN STOCK. PLEASE REFER TO GATES E-COMMERCE WEBSITE FOR UPDATED INFORMATION



06 QUAD-POWER 4 XPB-5VX

DESCRIPTION	PRODUCT NUMBER	DATUM LENGTH (MM)	EFFECTIVE LENGTH (INCH)	WEIGHT (KG)
XPB2120/5VX840	9645-02120	2120	84	0.273
XPB2150/5VX850	9645-02150	2150	85	0.277
XPB2186/5VX860	9645-02186	2186	86	0.282
XPB2240/5VX886	9645-02240	2240	88.6	0.289
XPB2280/5VX900	9645-02280	2280	90	0.294
XPB2300/5VX910	9645-02300	2300	91	0.297
XPB2360/5VX934	9645-02360	2360	93.4	0.305
XPB2410/5VX953	9645-02410	2410	95.3	0.311
XPB2433/5VX960	9645-02433	2433	96	0.314
XPB2500/5VX990	9645-02500	2500	99	0.322
XPB2530/5VX1000	9645-02530	2530	100	0.327
XPB2650/5VX1050	9645-02650	2650	105	0.342
XPB2680/5VX1060	9645-02680	2680	106	0.346
XPB2800/5VX1108	9645-02800	2800	110.8	0.361
XPB2840/5VX1120	9645-02840	2840	112	0.367
XPB2900/5VX1146	9645-02900	2900	114.6	0.374
XPB2990/5VX1180	9645-02990	2990	118	0.387
XPB3000/5VX1186	9645-03000	3000	118.6	0.387
XPB3150/5VX1245	9645-03150	3150	124.5	0.407
XPB3160/5VX1250	9645-03160	3160	125	0.408
XPB3320/5VX1312	9645-03320	3320	131.2	0.374
XPB3350/5VX1320	9645-03350	3350	132	0.378
XPB3440/5VX1359	9645-03440	3440	135.9	0.388
XPB3550/5VX1400	9645-03550	3550	140	0.401
XPB3750/5VX1481	9645-03750	3750	148.1	0.423
XPB3800/5VX1500	9645-03800	3800	150	0.429
XPB4000/5VX1579	9645-04000	4000	157.9	0.451
XPB4053/5VX1600	9645-04053	4053	160	0.457
XPB4250/5VX1678	9645-04250	4250	167.8	0.480
XPB4307/5VX1700	9645-04307	4307	170	0.486
XPB4500/5VX1776	9645-04500	4500	177.6	0.508
XPB4560/5VX1800	9645-04560	4560	180	0.515
XPB4750/5VX1875	9645-04750	4750	187.5	0.536
XPB4815/5VX1900	9645-04815	4815	190	0.544
XPB5000/5VX1973	9645-05000	5000	197.3	0.565
XPB5070/5VX2000	9645-05070	5070	200	0.573

* THE ITEM IS MADE-TO-ORDER, NOT IN STOCK. PLEASE REFER TO GATES E-COMMERCE WEBSITE FOR UPDATED INFORMATION



07 QUAD-POWER 4 XPC

DESCRIPTION	PRODUCT NUMBER	DATUM LENGTH (MM)	WEIGHT (KG)
XPC1900	9646-01900	1900	0.483
XPC2000	9646-02000	2000	0.506
XPC2120	9646-02120	2120	0.536
XPC2240	9646-02240	2240	0.569
XPC2360	9646-02360	2360	0.600
XPC2500	9646-02500	2500	0.632
XPC2650	9646-02650	2650	0.672
XPC2800	9646-02800	2800	0.710
XPC3000	9646-03000	3000	0.761
XPC3150	9646-03150	3150	0.800
XPC3350	9646-03350	3350	0.727
XPC3550	9646-03550	3550	0.771
XPC3750	9646-03750	3750	0.814
XPC4000	9646-04000	4000	0.869
XPC4250	9646-04250	4250	0.923
XPC4500	9646-04500	4500	0.978
XPC4750	9646-04750	4750	1.032
XPC5000	9646-05000	5000	1.087

08 SUPER HC SINGLE - SPZ/3V

DESCRIPTION	PRODUCT NUMBER	DATUM LENGTH (MM)	EFFECTIVE LENGTH (INCH)	WEIGHT (KG)
SPZ487	9331-00487	487		0.039
SPZ512	9331-00512	512		0.043
SPZ560	9331-00560	560		0.044
SPZ562	9331-00562	562		0.045
SPZ587	9331-00587	587		0.049
SPZ612	9331-00612	612		0.049
SPZ615	9331-00615	615		0.050
SPZ630/3V250	9331-00630	630	25.0	0.051
SPZ637	9331-00637	637		0.050
SPZ662	9331-00662	662		0.050
SPZ670/3V265	9331-00670	670	26.5	0.053
SPZ687	9331-00687	687		0.052
SPZ710/3V280	9331-00710	710	28.0	0.059
SPZ722	9331-00722*	722		0.060
SPZ730	9331-00730	730		0.060
SPZ737	9331-00737	737		0.060
SPZ750	9331-00750	750		0.059
SPZ762/3V300	9331-00762	762	30.0	0.060
SPZ772	9331-00772	772		0.064
SPZ775	9331-00775	775		0.061
SPZ787	9331-00787	787		0.060
SPZ800/3V315	9331-00800	800	31.5	0.063
SPZ812	9331-00812	812		0.062
SPZ825	9331-00825	825		0.065

* THE ITEM IS MADE-TO-ORDER, NOT IN STOCK. PLEASE REFER TO GATES E-COMMERCE WEBSITE FOR UPDATED INFORMATION

08 SUPER HC SINGLE - SPZ/3V

DESCRIPTION	PRODUCT NUMBER	DATUM LENGTH (MM)	EFFECTIVE LENGTH(INCH)	WEIGHT (KG)
SPZ837	9331-00837	837		0.065
SPZ850/3V335	9331-00850	850	33.5	0.070
SPZ862	9331-00862	862		0.066
SPZ875	9331-00875	875		0.069
SPZ887	9331-00887	887		0.070
SPZ900/3V355	9331-00900	900	35.5	0.071
SPZ912	9331-00912	912		0.069
SPZ925	9331-00925	925		0.073
SPZ937	9331-00937	937		0.071
SPZ950/3V375	9331-00950	950	37.5	0.075
SPZ962	9331-00962	962		0.075
SPZ975	9331-00975	975		0.080
SPZ987	9331-00987	987		0.081
SPZ1000	9331-01000	1000		0.079
SPZ1012/3V400	9331-01012	1012	40.0	0.079
SPZ1024	9331-01024	1024		0.085
SPZ1030	9331-01030	1030		0.081
SPZ1037	9331-01037	1037		0.079
SPZ1047	9331-01047	1047		0.087
SPZ1060/3V420	9331-01060	1060	42.0	0.084
SPZ1062	9331-01062	1062		0.081
SPZ1077/3V425	9331-01077	1077	42.5	0.090
SPZ1087	9331-01087	1087		0.083
SPZ1090	9331-01090	1090		0.083
SPZ1112	9331-01112	1112		0.085
SPZ1120	9331-01120	1120		0.088
SPZ1137/3V450	9331-01137	1137	45.0	0.090
SPZ1150	9331-01150	1150		0.091
SPZ1162	9331-01162	1162		0.089
SPZ1180	9331-01180	1180		0.093
SPZ1187	9331-01187	1187		0.091
SPZ1202/3V475	9331-01202	1202	47.5	0.100
SPZ1212	9331-01212	1212		0.093
SPZ1215	9331-01215	1215		0.093
SPZ1237	9331-01237	1237		0.094
SPZ1250	9331-01250	1250		0.099
SPZ1262/3V500	9331-01262	1262	50.0	0.100
SPZ1270	9331-01270	1270		0.101
SPZ1287	9331-01287	1287		0.098
SPZ1312	9331-01312	1312		0.100
SPZ1320	9331-01320	1320		0.104
SPZ1337/3V530	9331-01337	1337	53.0	0.102
SPZ1347	9331-01347	1347		0.112
SPZ1360	9331-01360	1360		0.110
SPZ1362	9331-01362	1362		0.104
SPZ1387	9331-01387	1387		0.110
SPZ1400	9331-01400	1400		0.111
SPZ1412/3V560	9331-01412	1412	56.0	0.120
SPZ1420	9331-01420	1420		0.113

* THE ITEM IS MADE-TO-ORDER, NOT IN STOCK. PLEASE REFER TO GATES E-COMMERCE WEBSITE FOR UPDATED INFORMATION



08 SUPER HC SINGLE - SPZ/3V

DESCRIPTION	PRODUCT NUMBER	DATUM LENGTH (MM)	EFFECTIVE LENGTH(INCH)	WEIGHT (KG)
SPZ1437	9331-01437	1437		0.110
SPZ1450	9331-01450	1450		0.120
SPZ1462	9331-01462	1462		0.120
SPZ1487	9331-01487	1487		0.120
SPZ1500/3V590	9331-01500	1500	59.0	0.119
SPZ1512/3V600	9331-01512	1512	60.0	0.126
SPZ1520	9331-01520	1520		0.121
SPZ1537	9331-01537	1537		0.130
SPZ1550	9331-01550	1550		0.130
SPZ1562	9331-01562	1562		0.130
SPZ1575	9331-01575*	1575		0.130
SPZ1587	9331-01587	1587		0.130
SPZ1600/3V630	9331-01600	1600	63.0	0.130
SPZ1612	9331-01612	1612		0.123
SPZ1637	9331-01637	1637		0.140
SPZ1650/3V650	9331-01650	1650	65.0	0.140
SPZ1662	9331-01662	1662		0.140
SPZ1687	9331-01687	1687		0.140
SPZ1700/3V670	9331-01700	1700	67.0	0.134
SPZ1737	9331-01737	1737		0.140
SPZ1750	9331-01750	1750		0.139
SPZ1762	9331-01762	1762		0.150
SPZ1787	9331-01787	1787		0.150
SPZ1800/3V710	9331-01800	1800	71.0	0.143
SPZ1812	9331-01812	1812		0.150
SPZ1837	9331-01837	1837		0.150
SPZ1850/3V730	9331-01850	1850	73.0	0.150
SPZ1862	9331-01862	1862		0.150
SPZ1887	9331-01887	1887		0.160
SPZ1900/3V750	9331-01900	1900	75.0	0.151
SPZ1937	9331-01937	1937		0.160
SPZ1950	9331-01950	1950		0.160
SPZ1987	9331-01987	1987		0.160
SPZ2000	9331-02000	2000		0.159
SPZ2037/3V800	9331-02037	2037	80.0	0.170
SPZ2060/3V810	9331-02060	2060	81.0	0.170
SPZ2120	9331-02120	2120		0.180
SPZ2137	9331-02137	2137		0.180
SPZ2150/3V850	9331-02150	2150	85.0	0.180
SPZ2180	9331-02180	2180		0.180
SPZ2187	9331-02187	2187		0.180
SPZ2240	9331-02240	2240		0.190
SPZ2287/3V900	9331-02287	2287	90.0	0.190
SPZ2360	9331-02360	2360		0.200
SPZ2410/3V950	9331-02410	2410	95.0	0.192
SPZ2430	9331-02430	2430		0.200
SPZ2500	9331-02500	2500		0.210
SPZ2540/3V1000	9331-02540	2540	100.0	0.210
SPZ2650	9331-02650	2650		0.220

* THE ITEM IS MADE-TO-ORDER, NOT IN STOCK. PLEASE REFER TO GATES E-COMMERCE WEBSITE FOR UPDATED INFORMATION

SUPER HC SINGLE



08 SUPER HC SINGLE - SPZ/3V

DESCRIPTION	PRODUCT NUMBER	DATUM LENGTH (MM)	EFFECTIVE LENGTH(INCH)	WEIGHT (KG)
SPZ2690/3V1060	9331-02690	2690	106.0	0.220
SPZ2800	9331-02800	2800		0.223
SPZ2840/3V1120	9331-02840	2840	112.0	0.240
SPZ3000/3V1180	9331-03000	3000	118.0	0.250
SPZ3150	9331-03150	3150		0.260
SPZ3170/3V1250	9331-03170	3170	125.0	0.253
SPZ3350/3V1320	9331-03350	3350	132.0	0.280
SPZ3550/3V1400	9331-03550	3550	140.0	0.300
SPZ3750	9331-03750*	3750		0.310

09 SUPER HC SINGLE - SPA

DESCRIPTION	PRODUCT NUMBER	DATUM LENGTH (MM)	WEIGHT (KG)
SPA732	9333-00732	732	0.100
SPA757	9333-00757	757	0.111
SPA782	9333-00782*	782	0.115
SPA800	9333-00800	800	0.109
SPA807	9333-00807	807	0.118
SPA832	9333-00832	832	0.114
SPA850	9333-00850	850	0.118
SPA857	9333-00857	857	0.118
SPA882	9333-00882	882	0.121
SPA900	9333-00900	900	0.123
SPA907	9333-00907	907	0.124
SPA925	9333-00925	925	0.130
SPA932	9333-00932	932	0.128
SPA950	9333-00950	950	0.131
SPA957	9333-00957	957	0.131
SPA975	9333-00975	975	0.133
SPA982	9333-00982	982	0.135
SPA1000	9333-01000	1000	0.137
SPA1007	9333-01007	1007	0.138
SPA1030	9333-01030	1030	0.141
SPA1032	9333-01032	1032	0.141
SPA1057	9333-01057	1057	0.150
SPA1060	9333-01060	1060	0.150
SPA1082	9333-01082	1082	0.149
SPA1090	9333-01090	1090	0.149
SPA1107	9333-01107	1107	0.152
SPA1120	9333-01120	1120	0.153
SPA1132	9333-01132	1132	0.156
SPA1150	9333-01150	1150	0.158
SPA1157	9333-01157	1157	0.159
SPA1180	9333-01180	1180	0.162

* THE ITEM IS MADE-TO-ORDER, NOT IN STOCK. PLEASE REFER TO GATES E-COMMERCE WEBSITE FOR UPDATED INFORMATION



09 SUPER HC SINGLE - SPA

DESCRIPTION	PRODUCT NUMBER	DATUM LENGTH (MM)	WEIGHT (KG)
SPA1207	9333-01207	1207	0.166
SPA1215	9333-01215	1215	0.166
SPA1232	9333-01232	1232	0.169
SPA1250	9333-01250	1250	0.171
SPA1257	9333-01257	1257	0.173
SPA1272	9333-01272*	1272	0.170
SPA1282	9333-01282	1282	0.176
SPA1285	9333-01285	1285	0.180
SPA1307	9333-01307	1307	0.180
SPA1320	9333-01320	1320	0.181
SPA1332	9333-01332	1332	0.183
SPA1357	9333-01357	1357	0.187
SPA1360	9333-01360	1360	0.190
SPA1382	9333-01382	1382	0.190
SPA1400	9333-01400	1400	0.192
SPA1407	9333-01407	1407	0.194
SPA1432	9333-01432	1432	0.197
SPA1450	9333-01450	1450	0.200
SPA1457	9333-01457	1457	0.200
SPA1482	9333-01482	1482	0.204
SPA1500	9333-01500	1500	0.206
SPA1507	9333-01507	1507	0.207
SPA1532	9333-01532	1532	0.211
SPA1550	9333-01550	1550	0.210
SPA1557	9333-01557	1557	0.214
SPA1582	9333-01582	1582	0.232
SPA1600	9333-01600	1600	0.220
SPA1607	9333-01607	1607	0.235
SPA1632	9333-01632	1632	0.239
SPA1650	9333-01650	1650	0.230
SPA1657	9333-01657	1657	0.230
SPA1682	9333-01682*	1682	0.230
SPA1700	9333-01700	1700	0.234
SPA1707	9333-01707	1707	0.250
SPA1732	9333-01732	1732	0.240
SPA1750	9333-01750	1750	0.240
SPA1757	9333-01757	1757	0.240
SPA1782	9333-01782	1782	0.245
SPA1800	9333-01800	1800	0.248
SPA1807	9333-01807	1807	0.265
SPA1832	9333-01832	1832	0.250
SPA1850	9333-01850*	1850	0.250
SPA1857	9333-01857	1857	0.260
SPA1882	9333-01882	1882	0.260
SPA1900	9333-01900	1900	0.261
SPA1907	9333-01907	1907	0.279
SPA1932	9333-01932	1932	0.270
SPA1950	9333-01950	1950	0.270
SPA1957	9333-01957	1957	0.270

* THE ITEM IS MADE-TO-ORDER, NOT IN STOCK. PLEASE REFER TO GATES E-COMMERCE WEBSITE FOR UPDATED INFORMATION

SUPER HC SINGLE



09 SUPER HC SINGLE - SPA

DESCRIPTION	PRODUCT NUMBER	DATUM LENGTH (MM)	WEIGHT (KG)
SPA1982	9333-01982	1982	0.270
SPA2000	9333-02000	2000	0.275
SPA2032	9333-02032	2032	0.280
SPA2057	9333-02057*	2057	0.280
SPA2060	9333-02060	2060	0.280
SPA2082	9333-02082	2082	0.290
SPA2120	9333-02120	2120	0.292
SPA2132	9333-02132	2132	0.290
SPA2180	9333-02180*	2180	0.320
SPA2182	9333-02182	2182	0.320
SPA2207	9333-02207	2207	0.320
SPA2232	9333-02232	2232	0.327
SPA2240	9333-02240	2240	0.309
SPA2282	9333-02282	2282	0.330
SPA2300	9333-02300	2300	0.340
SPA2307	9333-02307	2307	0.340
SPA2332	9333-02332	2332	0.340
SPA2360	9333-02360	2360	0.325
SPA2382	9333-02382	2382	0.350
SPA2430	9333-02430	2430	0.360
SPA2432	9333-02432	2432	0.360
SPA2482	9333-02482	2482	0.360
SPA2500	9333-02500	2500	0.330
SPA2532	9333-02532	2532	0.370
SPA2582	9333-02582*	2582	0.380
SPA2607	9333-02607	2607	0.380
SPA2632	9333-02632	2632	0.380
SPA2650	9333-02650	2650	0.365
SPA2682	9333-02682	2682	0.390
SPA2732	9333-02732	2732	0.403
SPA2782	9333-02782*	2782	0.410
SPA2800	9333-02800	2800	0.410
SPA2832	9333-02832	2832	0.410
SPA2847	9333-02847	2847	0.420
SPA2882	9333-02882*	2882	0.420
SPA2900	9333-02900	2900	0.420
SPA2932	9333-02932	2932	0.430
SPA2982	9333-02982	2982	0.440
SPA3000	9333-03000	3000	0.440
SPA3032	9333-03032	3032	0.420
SPA3082	9333-03082	3082	0.450
SPA3150	9333-03150	3150	0.440
SPA3182	9333-03182	3182	0.470
SPA3282	9333-03282	3282	0.460
SPA3350	9333-03350	3350	0.472
SPA3382	9333-03382*	3382	0.500
SPA3450	9333-03450	3450	0.509
SPA3550	9333-03550	3550	0.492
SPA3650	9333-03650*	3650	0.510

* THE ITEM IS MADE-TO-ORDER, NOT IN STOCK. PLEASE REFER TO GATES E-COMMERCE WEBSITE FOR UPDATED INFORMATION



09 SUPER HC SINGLE - SPA

DESCRIPTION	PRODUCT NUMBER	DATUM LENGTH (MM)	WEIGHT (KG)
SPA3750	9333-03750	3750	0.530
SPA4000	9333-04000	4000	0.590
SPA4250	9333-04250	4250	0.595
SPA4500	9333-04500	4500	0.630
SPA5000	9333-05000*	5000	0.700

10 SUPER HC SINGLE - SPB/5V

DESCRIPTION	PRODUCT NUMBER	DATUM LENGTH (MM)	EFFECTIVE LENGTH (INCH)	WEIGHT (KG)
SPB1250	9339-01250	1250		0.268
SPB1260/5V500	9339-01260	1260	50	0.271
SPB1320	9339-01320	1320		0.29
SPB1340/5V530	9339-01340*	1340	53	0.288
SPB1360	9339-01360	1360		0.300
SPB1400	9339-01400	1400		0.310
SPB1410/5V560	9339-01410	1410	56	0.303
SPB1450	9339-01450	1450		0.320
SPB1500	9339-01500	1500		0.338
SPB1510/5V600	9339-01510	1510	60	0.325
SPB1550	9339-01550	1550		0.340
SPB1590/5V630	9339-01590	1590	63	0.342
SPB1600	9339-01600	1600		0.361
SPB1650	9339-01650	1650		0.360
SPB1690/5V670	9339-01690	1690	67	0.359
SPB1700	9339-01700	1700		0.380
SPB1750	9339-01750	1750		0.390
SPB1778	9339-01778*	1778		0.390
SPB1790/5V710	9339-01790	1790	71	0.377
SPB1800	9339-01800	1800		0.404
SPB1850	9339-01850	1850		0.410
SPB1860	9339-01860*	1860		0.410
SPB1900/5V750	9339-01900	1900	75	0.430
SPB1930	9339-01930*	1930		0.430
SPB1950	9339-01950	1950		0.430
SPB2000	9339-02000	2000		0.454
SPB2020/5V800	9339-02020	2020	80	0.450
SPB2060	9339-02060	2060		0.460
SPB2098	9339-02098*	2098		0.470
SPB2120	9339-02120	2120		0.491
SPB2150/5V850	9339-02150	2150	85	0.480
SPB2180	9339-02180	2180		0.490
SPB2200	9339-02200*	2200		0.490
SPB2240	9339-02240	2240		0.510
SPB2280/5V900	9339-02280	2280	90	0.510
SPB2300	9339-02300	2300		0.520

* THE ITEM IS MADE-TO-ORDER, NOT IN STOCK. PLEASE REFER TO GATES E-COMMERCE WEBSITE FOR UPDATED INFORMATION

SUPER HC SINGLE

10 SUPER HC SINGLE - SPB/5V

DESCRIPTION	PRODUCT NUMBER	DATUM LENGTH (MM)	EFFECTIVE LENGTH (INCH)	WEIGHT (KG)
SPB2360/5V930	9339-02360	2360	93	0.518
SPB2391	9339-02391*	2391		0.540
SPB2400/5V950	9339-02400	2400	95	0.540
SPB2430	9339-02430	2430		0.547
SPB2450	9339-02450	2450		0.550
SPB2500	9339-02500	2500		0.580
SPB2530/5V1000	9339-02530	2530	100	0.533
SPB2580	9339-02580	2580		0.581
SPB2600	9339-02600*	2600		0.580
SPB2650	9339-02650	2650		0.618
SPB2680/5V1060	9339-02680	2680	106	0.600
SPB2720	9339-02720	2720		0.612
SPB2800	9339-02800	2800		0.643
SPB2840/5V1120	9339-02840	2840	112	0.640
SPB2850	9339-02850	2850		0.640
SPB2900	9339-02900	2900		0.650
SPB2980/5V1180	9339-02985	2985	118	0.628
SPB3000	9339-03000	3000		0.690
SPB3070	9339-03070	3070		0.691
SPB3150	9339-03150	3150		0.778
SPB3170/5V1250	9339-03170	3170	125	0.668
SPB3250	9339-03250	3250		0.730
SPB3350/5V1320	9339-03350	3350	132	0.808
SPB3450	9339-03450	3450		0.775
SPB3550/5V1400	9339-03550	3550	140	0.863
SPB3650	9339-03650	3650		0.820
SPB3700	9339-03700*	4100		0.820
SPB3750	9339-03750	3750		0.902
SPB3800/5V1500	9339-03800	3800	150	0.850
SPB3870	9339-03870	3870		0.870
SPB4000	9339-04000	4000		0.978
SPB4050/5V1600	9339-04050	4050	160	0.854
SPB4100	9339-04100*	4100		0.930
SPB4120	9339-04120	4120		0.930
SPB4250	9339-04250	4250		1.038
SPB4310/5V1700	9339-04310	4310	170	0.909
SPB4370	9339-04370	4370		0.983
SPB4500	9339-04500	4500		1.010
SPB4560/5V1800	9339-04560	4560	180	0.964
SPB4750	9339-04750	4750		1.170
SPB4820/5V1900	9339-04820*	4820	190	1.120
SPB4870	9339-04870	4870		1.130
SPB5000	9339-05000	5000		1.232
SPB5070/5V2000	9339-05070	5070	200	1.071
SPB5300	9339-05300	5300		1.298
SPB5370/5V2120	9339-05370	5370	212	1.134
SPB5600	9339-05600	5600		1.372
SPB5680/5V2240	9339-05680	5680	224	0.893
SPB5980/5V2360	9339-05980	5980	236	1.260

* THE ITEM IS MADE-TO-ORDER, NOT IN STOCK. PLEASE REFER TO GATES E-COMMERCE WEBSITE FOR UPDATED INFORMATION



10 SUPER HC SINGLE - SPB/5V

DESCRIPTION	PRODUCT NUMBER	DATUM LENGTH (MM)	EFFECTIVE LENGTH (INCH)	WEIGHT (KG)
SPB6000	9339-06000	6000		1.470
SPB6300	9339-06300	6300		1.500
SPB6340/5V2500	9339-06340	6340	250	1.325
SPB6700/5V2650	9339-06700	6700	265	1.550
SPB7100/5V2800	9339-07100	7100	280	1.640
SPB7500	9339-07500	7500		1.730
SPB7610/5V3000	9339-07610	7610	300	1.591
SPB8000/5V3150	9339-08000	8000	315	1.850
SPB8500/5V3350	9339-08500	8500	335	1.776
SPB9010/5V3550	9339-09010	9010	355	1.883

11 SUPER HC SINGLE - SPC

DESCRIPTION	PRODUCT NUMBER	DATUM LENGTH (MM)	WEIGHT (KG)
SPC2000	9335-02000	2000	0.876
SPC2120	9335-02120	2120	0.916
SPC2240	9335-02240	2240	0.968
SPC2360	9335-02360	2360	0.980
SPC2500	9335-02500	2500	1.040
SPC2550	9335-02550*	2550	1.060
SPC2650	9335-02650	2650	1.100
SPC2800	9335-02800	2800	1.207
SPC3000	9335-03000	3000	1.302
SPC3150	9335-03150	3150	1.377
SPC3350	9335-03350	3350	1.480
SPC3550	9335-03550	3550	1.547
SPC3750	9335-03750	3750	1.636
SPC4000	9335-04000	4000	1.760
SPC4100	9335-04100*	4100	1.720
SPC4250	9335-04250	4250	1.887
SPC4500	9335-04500	4500	1.983
SPC4750	9335-04750	4750	2.090
SPC5000	9335-05000	5000	2.213
SPC5300	9335-05300	5300	2.337
SPC5600	9335-05600	5600	2.420
SPC5800	9335-05800	5800	2.510
SPC6000	9335-06000	6000	2.653
SPC6300	9335-06300	6300	2.837
SPC6500	9335-06500*	6500	2.740
SPC6700	9335-06700	6700	2.927
SPC7100	9335-07100	7100	3.134
SPC7500	9335-07500	7500	3.307
SPC8000	9335-08000	8000	3.572
SPC8500	9335-08500	8500	3.725
SPC9000	9335-09000	9000	3.790

* THE ITEM IS MADE-TO-ORDER, NOT IN STOCK. PLEASE REFER TO GATES E-COMMERCE WEBSITE FOR UPDATED INFORMATION

SUPER HC SINGLE



11 SUPER HC SINGLE - SPC

DESCRIPTION	PRODUCT NUMBER	DATUM LENGTH (MM)	WEIGHT (KG)
SPC9500	9335-09500	9500	3.510
SPC10000	9335-10000	10000	3.695
SPC10600	9335-10600	10600	3.917
SPC11200	9335-11200	11200	4.139
SPC11800	9335-11800*	11800	4.360
SPC12000	9335-12000*	12000	4.434
SPC12500	9335-12500	12500	4.619
SPC13500	9335-13500*	13500	4.498
SPC13800	9335-13800*	13800	5.099
SPC14200	9335-14200*	14200	5.247
SPC15000	9335-15000*	15000	5.543
SPC16500	9335-16500*	16500	6.097

SUPER HC SINGLE

12 SUPER HC SINGLE - 8V

DESCRIPTION	PRODUCT NUMBER	DATUM LENGTH (MM)	EFFECTIVE LENGTH (INCH)	WEIGHT (KG)
8V1000	9336-31000	2540	100	0.489
8V1060	9336-31060	2690	106	0.518
8V1120	9336-31120	2845	112	0.548
8V1180	9336-31180	2995	118	0.577
8V1250	9336-31250	3175	125	1.760
8V1320	9336-31320	3355	132	1.860
8V1400	9336-31400	3555	140	1.970
8V1500	9336-31500	3810	150	2.110
8V1600	9336-31600	4065	160	2.250
8V1700	9336-31700	4320	170	2.400
8V1800	9336-31800	4570	180	2.540
8V1900	9336-31900	4825	190	2.680
8V2000	9336-32000	5080	200	2.820
8V2120	9336-32120	5385	212	2.990
8V2240	9336-32240	5690	224	3.150
8V2360	9336-32360	5995	236	3.320
8V2500	9336-32500	6350	250	3.520
8V2650	9336-32650	6730	265	3.730
8V2800	9336-32800	7110	280	3.940
8V3000	9336-33000	7620	300	4.220
8V3150	9336-33150	8000	315	4.440
8V3350	9336-33350	8510	335	4.720
8V3550	9336-33550	9015	355	4.990
8V3750	9336-33750	9525	375	5.280
8V4000	9336-34000	10160	400	5.630
8V4250	9336-34250	10795	425	5.980
8V4500	9336-34500	11430	450	6.340
8V4750	9336-34750	12065	475	6.690
8V5000	9336-35000	12700	500	7.040
8V5600	9336-35600	14225	560	7.890

* THE ITEM IS MADE-TO-ORDER, NOT IN STOCK. PLEASE REFER TO GATES E-COMMERCE WEBSITE FOR UPDATED INFORMATION



13 SUPER HC MN XPZ

DESCRIPTION	PRODUCT NUMBER	DATUM LENGTH (MM)	WEIGHT (KG)
XPZ575/3VX228	9412-90575	575	0.029
XPZ615/3VX244	9412-90615	615	0.031
XPZ635/3VX252	9412-90635	635	0.032
XPZ710/3VX280	9412-90710*	710	0.036
XPZ755/3VX297	9412-90755	755	0.038
XPZ765/3VX300	9412-90765	765	0.039
XPZ800/3VX315	9412-90800	800	0.041
XPZ830/3VX326	9412-90830	830	0.042
XPZ850/3VX335	9412-90850	850	0.043
XPZ865/3VX342	9412-90865*	865	0.044
XPZ875/3VX344	9412-90875*	875	0.045
XPZ900/3VX355	9412-90900	900	0.046
XPZ925/3VX366	9412-90925	925	0.047
XPZ935/3VX370	9412-90935*	935	0.048
XPZ960/3VX375	9412-90960	960	0.049
XPZ975/3VX385	9412-90975	975	0.050
XPZ980/3VX390	9412-90980	980	0.051
XPZ1015/3VX400	9412-91015	1015	0.052
XPZ1035/3VX405	9412-91035	1035	0.053
XPZ1055/3VX415	9412-91055	1055	0.054
XPZ1080/3VX425	9412-91080*	1080	0.055
XPZ1120/3VX442	9412-91120	1120	0.058
XPZ1140/3VX450	9412-91140	1140	0.059
XPZ1162/3VX459	9412-91162*	1162	0.059
XPZ1180/3VX464	9412-91180	1180	0.060
XPZ1205/3VX475	9412-91205	1205	0.062
XPZ1212/3VX480	9412-91212*	1212	0.063
XPZ1237/3VX487	9412-91237	1237	0.064
XPZ1270/3VX500	9412-91270*	1270	0.065
XPZ1280/3VX505	9412-91280	1280	0.066
XPZ1312/3VX515	9412-91312*	1312	0.067
XPZ1320/3VX520	9412-91320	1320	0.068
XPZ1345/3VX530	9412-91345	1345	0.069
XPZ1350/3VX533	9412-91350	1350	0.069
XPZ1365/3VX540	9412-91365	1365	0.070
XPZ1400/3VX550	9412-91400	1400	0.072
XPZ1420/3VX560	9412-91420	1420	0.073
XPZ1437/3VX565	9412-91437	1437	0.073
XPZ1450/3VX570	9412-91450	1450	0.744
XPZ1470/3VX580	9412-91470	1470	0.076
XPZ1500/3VX590	9412-91500	1500	0.077
XPZ1520/3VX600	9412-91520	1520	0.078
XPZ1545/3VX610	9412-91545	1545	0.079
XPZ1562/3VX617	9412-91562	1562	0.080
XPZ1590/3VX628	9412-91590	1590	0.082
XPZ1600/3VX630	9412-91600	1600	0.082
XPZ1645/3VX649	9412-91645	1645	0.085
XPZ1650/3VX650	9412-91650	1650	0.085
XPZ1700/3VX670	9412-91700	1700	0.088

* THE ITEM IS MADE-TO-ORDER, NOT IN STOCK. PLEASE REFER TO GATES E-COMMERCE WEBSITE FOR UPDATED INFORMATION

SUPER HC MN



13 SUPER HC MN XPZ

DESCRIPTION	PRODUCT NUMBER	DATUM LENGTH (MM)	WEIGHT (KG)
XPZ1750/3VX690	9412-91750	1750	0.090
XPZ1800/3VX710	9412-91800	1800	0.093
XPZ1840/3VX726	9412-91840	1840	0.095
XPZ1875/3VX740	9412-91875	1875	0.097
XPZ1890/3VX742	9412-91890	1890	0.097
XPZ1930/3VX762	9412-91930*	1930	0.099
XPZ1950/3VX768	9412-91950	1950	0.100
XPZ1990/3VX785	9412-91990	1990	0.103
XPZ2030/3VX800	9412-92030	2030	0.105
XPZ2105/3VX830	9412-92105	2105	0.109
XPZ2120/3VX836	9412-92120	2120	0.109
XPZ2160/3VX850	9412-92160*	2160	0.112
XPZ2240/3VX885	9412-92240	2240	0.115
XPZ2290/3VX903	9412-92290*	2290	0.118
XPZ2415/3VX950	9412-92415*	2415	0.125
XPZ2540/3VX1000	9412-92540*	2540	0.117
XPZ2650/3VX1045	9412-92650*	2650	0.137
XPZ2690/3VX1060	9412-92690*	2690	0.139
XPZ2800/3VX1104	9412-92800*	2800	0.145

14 SUPER HC MN XPA

DESCRIPTION	PRODUCT NUMBER	DATUM LENGTH (MM)	WEIGHT (KG)
XPA760	9413-90760*	760	0.071
XPA805	9413-90805*	805	0.075
XPA855	9413-90855	855	0.079
XPA885	9413-90885	885	0.082
XPA905	9413-90905	905	0.084
XPA955	9413-90955	955	0.089
XPA985	9413-90985*	985	0.091
XPA1007	9413-91007	1007	0.094
XPA1030	9413-91030	1030	0.096
XPA1070	9413-91070	1070	0.100
XPA1085	9413-91085*	1085	0.101
XPA1115	9413-91115*	1115	0.104
XPA1120	9413-91120	1120	0.104
XPA1135	9413-91135	1135	0.106
XPA1155	9413-91155*	1155	0.108
XPA1190	9413-91190	1190	0.111
XPA1210	9413-91210	1210	0.113
XPA1235	9413-91235	1235	0.115
XPA1260	9413-91260	1260	0.118
XPA1280	9413-91280*	1280	0.119
XPA1310	9413-91310*	1310	0.123
XPA1320	9413-91320	1320	0.123

* THE ITEM IS MADE-TO-ORDER, NOT IN STOCK. PLEASE REFER TO GATES E-COMMERCE WEBSITE FOR UPDATED INFORMATION



14 SUPER HC MN XPA

DESCRIPTION	PRODUCT NUMBER	DATUM LENGTH (MM)	WEIGHT (KG)
XPA1345	9413-91345	1345	0.125
XPA1360	9413-91360*	1360	0.127
XPA1375	9413-91375	1375	0.128
XPA1405	9413-91405	1405	0.131
XPA1430	9413-91430	1430	0.134
XPA1455	9413-91455*	1455	0.136
XPA1485	9413-91485*	1485	0.139
XPA1510	9413-91510	1510	0.141
XPA1525	9413-91525*	1525	0.143
XPA1560	9413-91560*	1560	0.146
XPA1595	9413-91595	1595	0.149
XPA1605	9413-91605	1605	0.150
XPA1630	9413-91630*	1630	0.152
XPA1660	9413-91660*	1660	0.155
XPA1685	9413-91685	1685	0.158
XPA1705	9413-91705	1705	0.160
XPA1730	9413-91730	1730	0.162
XPA1750	9413-91750*	1750	0.164
XPA1760	9413-91760*	1760	0.165
XPA1780	9413-91780*	1780	0.166
XPA1805	9413-91805	1805	0.169
XPA1815	9413-91815	1815	0.152
XPA1850	9413-91850*	1850	0.154
XPA1875	9413-91875*	1875	0.157
XPA1890	9413-91890	1890	0.158
XPA1920	9413-91920*	1920	0.161
XPA1950	9413-91950*	1950	0.163
XPA1975	9413-91975*	1975	0.165
XPA2000	9413-92000	2000	0.167
XPA2025	9413-92025	2025	0.169
XPA2060	9413-92060*	2060	0.172
XPA2080	9413-92080*	2080	0.174
XPA2120	9413-92120	2120	0.177
XPA2185	9413-92185	2185	0.183
XPA2210	9413-92210*	2210	0.185
XPA2240	9413-92240	2240	0.187
XPA2275	9413-92275*	2275	0.190
XPA2285	9413-92285	2285	0.191
XPA2340	9413-92340	2340	0.196
XPA2360	9413-92360	2360	0.198
XPA2435	9413-92435*	2435	0.204
XPA2470	9413-92470*	2470	0.207
XPA2500	9413-92500	2500	0.209
XPA2535	9413-92535*	2535	0.212
XPA2570	9413-92570	2570	0.215
XPA2650	9413-92650	2650	0.222
XPA2682	9413-92682*	2682	0.224
XPA2715	9413-92715*	2715	0.227
XPA2800	9413-92800	2800	0.234

* THE ITEM IS MADE-TO-ORDER, NOT IN STOCK. PLEASE REFER TO GATES E-COMMERCE WEBSITE FOR UPDATED INFORMATION



14 SUPER HC MN XPA

DESCRIPTION	PRODUCT NUMBER	DATUM LENGTH (MM)	WEIGHT (KG)
XPA2895	9413-92895*	2895	0.242
XPA3000	9413-93000*	3000	0.251
XPA3150	9413-93150*	3150	0.264
XPA3550	9413-93550*	3550	0.298

15 SUPER HC MN XPB

DESCRIPTION	PRODUCT NUMBER	DATUM LENGTH (MM)	WEIGHT (KG)
XPB1260/5VX500	9414-91260	1260	0.190
XPB1310/5VX519	9414-91310	1310	0.198
XPB1340/5VX530	9414-91340*	1340	0.203
XPB1390/5VX550	9414-91390	1390	0.210
XPB1410/5VX560	9414-91410	1410	0.213
XPB1500/5VX595	9414-91500	1500	0.228
XPB1600/5VX634	9414-91600*	1600	0.242
XPB1700/5VX674	9414-91700*	1700	0.258
XPB1750/5VX693	9414-91750	1750	0.266
XPB1800/5VX713	9414-91800	1800	0.273
XPB1900/5VX750	9414-91900	1900	0.279
XPB2000/5VX790	9414-92000	2000	0.283
XPB2020/5VX800	9414-92020*	2020	0.287
XPB2120/5VX840	9414-92120	2120	0.301
XPB2150/5VX850	9414-92150	2150	0.305
XPB2170/5VX860	9414-92170	2170	0.308
XPB2250/5VX890	9414-92250	2250	0.320
XPB2280/5VX900	9414-92280	2280	0.323
XPB2350/5VX928	9414-92350	2350	0.334
XPB2400/5VX947	9414-92400	2400	0.341
XPB2500/5VX987	9414-92500	2500	0.355
XPB2530/5VX1000	9414-92530	2530	0.361
XPB2650/5VX1047	9414-92650	2650	0.377
XPB2680/5VX1060	9414-92680	2680	0.382
XPB2800/5VX1108	9414-92800	2800	0.398
XPB2840/5VX1123	9414-92840*	2840	0.404
XPB3000/5VX1186	9414-93000	3000	0.427
XPB3160/5VX1246	9414-93160	3160	0.449
XPB3350/5VX1320	9414-93350	3350	0.476
XPB3550/5VX1400	9414-93550	3550	0.491

* THE ITEM IS MADE-TO-ORDER, NOT IN STOCK. PLEASE REFER TO GATES E-COMMERCE WEBSITE FOR UPDATED INFORMATION



16 TRI-POWER - AX

DESCRIPTION	PRODUCT NUMBER	DATUM LENGTH (MM)	EFFECTIVE LENGTH (INCH)	WEIGHT (KG)
AX21	9012-02021*	578	23	0.055
AX22	9012-02022	602	24	0.056
AX23	9012-02023*	625	25	0.058
AX25	9012-02025	673	27	0.063
AX26	9012-02026	701	28	0.066
AX28	9012-02028	752	30	0.071
AX30	9012-02030	803	32	0.076
AX31	9012-02031	827	33	0.078
AX32	9012-02032	851	34	0.080
AX33	9012-02033	881	35	0.083
AX34	9012-02034	907	36	0.086
AX35	9012-02035	931	37	0.088
AX36	9012-02036	955	38	0.090
AX37	9012-02037	981	39	0.093
AX38	9012-02038	1007	40	0.095
AX39	9012-02039	1031	41	0.098
AX40	9012-02040	1057	42	0.100
AX41	9012-02041	1081	43	0.102
AX42	9012-02042	1108	44	0.105
AX43	9012-02043	1132	45	0.107
AX44	9012-02044	1159	46	0.110
AX45	9012-02045	1183	47	0.112
AX46	9012-02046	1210	48	0.115
AX47	9012-02047	1234	49	0.117
AX48	9012-02048	1261	50	0.120
AX49	9012-02049*	1286	51	0.122
AX50	9012-02050	1309	52	0.124
AX51	9012-02051*	1337	53	0.127
AX52	9012-02052*	1361	54	0.129
AX53	9012-02053*	1388	55	0.132
AX54	9012-02054	1412	56	0.134
AX55	9012-02055	1436	57	0.137
AX56	9012-02056	1463	58	0.139
AX57	9012-02057*	1487	59	0.014
AX58	9012-02058*	1514	60	0.144
AX61	9012-02061*	1589	63	0.151
AX62	9012-02062	1613	64	0.154
AX65	9012-02065*	1690	67	0.161
AX68	9012-02068*	1765	70	0.168

TRI-POWER

* THE ITEM IS MADE-TO-ORDER, NOT IN STOCK. PLEASE REFER TO GATES E-COMMERCE WEBSITE FOR UPDATED INFORMATION



17 TRI-POWER - BX

DESCRIPTION	PRODUCT NUMBER	DATUM LENGTH (MM)	EFFECTIVE LENGTH (INCH)	WEIGHT (KG)
BX33	9013-02033*	899	36	0.135
BX34	9013-02034*	920	37	0.138
BX35	9013-02035*	947	38	0.142
BX36	9013-02036	971	39	0.146
BX37	9013-02037	997	40	0.150
BX38	9013-02038	1023	41	0.154
BX39	9013-02039	1052	42	0.158
BX41	9013-02041	1097	44	0.165
BX42	9013-02042	1124	45	0.169
BX43	9013-02043	1145	46	0.172
BX44	9013-02044	1175	47	0.177
BX45	9013-02045	1205	48	0.181
BX46	9013-02046	1226	49	0.185
BX47	9013-02047	1250	50	0.188
BX48	9013-02048	1277	51	0.192
BX49	9013-02049	1301	52	0.196
BX50	9013-02050	1325	53	0.200
BX51	9013-02051*	1350	54	0.203
BX52	9013-02052	1377	55	0.208
BX53	9013-02053	1401	56	0.211
BX54	9013-02054	1425	57	0.215
BX55	9013-02055	1452	58	0.219
BX56	9013-02056*	1479	59	0.223
BX57	9013-02057*	1503	60	0.227
BX58	9013-02058*	1530	61	0.231
BX59	9013-02059*	1554	62	0.234
BX60	9013-02060	1578	63	0.238
BX61	9013-02061*	1605	64	0.242
BX62	9013-02062	1629	65	0.246
BX63	9013-02063*	1656	66	0.250
BX64	9013-02064*	1682	67	0.254
BX65	9013-02065*	1706	68	0.258
BX66	9013-02066*	1736	69	0.262
BX67	9013-02067*	1760	70	0.266
BX70	9013-02070*	1841	73	0.278
BX71	9013-02071*	1856	74	0.281
BX72	9013-02072*	1883	75	0.285
BX73	9013-02073*	1911	76	0.289
BX74	9013-02074*	1948	77	0.295
BX75	9013-02075	1953	78	0.295

* THE ITEM IS MADE-TO-ORDER, NOT IN STOCK. PLEASE REFER TO GATES E-COMMERCE WEBSITE FOR UPDATED INFORMATION



18 TRI-POWER - CX

DESCRIPTION	PRODUCT NUMBER	DATUM LENGTH (MM)	EFFECTIVE LENGTH (INCH)	WEIGHT (KG)
CX51	9014-02051*	1422	55	0.350
CX60	9014-02060*	1651	64	0.490
CX68	9014-02068*	1854	72	0.570
CX75	9014-02075*	2032	79	0.610
CX78	9014-02078*	2083	82	0.630
CX81	9014-02081*	2159	85	0.640
CX83	9014-02083*	2210	87	0.650
CX85	9014-02085*	2286	89	0.660
CX90	9014-02090*	2413	94	0.575
CX96	9014-02096*	2540	100	0.730
CX100	9014-02100*	2667	105	0.770
CX101	9014-02101*	2692	106	0.790
CX105	9014-02105*	2769	109	0.820
CX106	9014-02106*	2794	110	0.820
CX109	9014-02109*	2896	114	0.840
CX112	9014-02112*	2946	116	0.870
CX115	9014-02115*	3048	120	0.880
CX120	9014-02120*	3175	125	0.910
CX123	9014-02123*	3226	127	0.950
CX128	9014-02128*	3378	133	0.980
CX133	9014-02133*	3505	138	1.000
CX136	9014-02136*	3581	141	1.050
CX144	9014-02144*	3785	149	0.900
CX150	9014-02150*	3937	155	1.180
CX158	9014-02158*	4140	163	1.270
CX162	9014-02162*	4242	167	1.320
CX173	9014-02173*	4521	178	0.900
CX180	9014-02180*	4699	185	1.500
CX187	9014-02187*	4877	192	1.590
CX190	9014-02190*	4953	195	1.610
CX195	9014-02195*	5080	200	1.680
CX210	9014-02210*	5461	215	1.810
CX225	9014-02225*	5766	227	2.040
CX240	9014-02240*	6147	242	2.220
CX255	9014-02255*	6528	257	2.400
CX270	9014-02270*	6909	272	2.630
CX300	9014-02300*	7671	302	3.060
CX330	9014-02330*	8433	332	3.580
CX360	9014-02360*	9195	362	4.080

* THE ITEM IS MADE-TO-ORDER, NOT IN STOCK. PLEASE REFER TO GATES E-COMMERCE WEBSITE FOR UPDATED INFORMATION



19 HI-POWER - Z

DESCRIPTION	PRODUCT NUMBER	INSIDE LENGTH (MM)	DATUM LENGTH (MM)	WEIGHT (KG)
Z16	9001-10016	425	447	0.032
Z17.5	9001-20175	450	470	0.033
Z18.5	9001-20185	475	495	0.040
Z19	9001-10019	485	505	0.040
Z19.5	9001-20195	500	520	0.040
Z20	9001-10020	515	537	0.038
Z20.5	9001-20205	530	550	0.039
Z22	9001-10022	560	580	0.041
Z22.5	9001-20225	575	595	0.042
Z23.5	9001-20235	600	620	0.044
Z24	9001-10024	610	630	0.045
Z25	9001-10025	630	655	0.050
Z26	9001-10026	653	675	0.048
Z26.5	9001-20265	670	695	0.049
Z28	9001-10028	710	730	0.052
Z28.5	9001-20285	725	747	0.053
Z29	9001-10029	730	755	0.054
Z29.5	9001-20295	750	770	0.055
Z30.5	9001-20305	775	795	0.060
Z31	9001-10031	785	805	0.060
Z31.5	9001-20315	800	820	0.060
Z32.5	9001-20325	825	845	0.060
Z33.5	9001-20335	850	870	0.062
Z34	9001-10034	865	887	0.063
Z34.5	9001-20345	875	895	0.063
Z35.5	9001-20355	900	920	0.070
Z36	9001-10036	910	930	0.070
Z37	9001-10037	935	955	0.070
Z37.5	9001-20375	950	970	0.069
Z38.5	9001-20385	975	995	0.070
Z39	9001-10039	980	1005	0.071
Z39.5	9001-20395	1000	1020	0.072
Z40	9001-10040	1016	1038	0.074
Z41	9001-10041	1040	1063	0.076
Z41.5	9001-20415	1050	1070	0.080
Z42	9001-10042	1060	1080	0.080
Z44	9001-10044	1120	1140	0.054
Z45	9001-10045	1150	1170	0.081
Z45.5	9001-20455	1160	1180	0.084
Z46	9001-10046	1180	1200	0.085
Z47	9001-10047	1200	1220	0.084
Z48	9001-10048	1225	1245	0.088
Z48.5	9001-20485	1230	1255	0.090
Z49	9001-10049	1250	1270	0.090
Z50	9001-10050	1275	1295	0.092
Z51	9001-10051	1300	1320	0.091
Z52	9001-10052	1320	1340	0.095
Z53	9001-10053	1346	1368	0.100
Z54	9001-10054	1371	1393	0.100

* THE ITEM IS MADE-TO-ORDER, NOT IN STOCK. PLEASE REFER TO GATES E-COMMERCE WEBSITE FOR UPDATED INFORMATION



19 HI-POWER - Z

DESCRIPTION	PRODUCT NUMBER	INSIDE LENGTH (MM)	DATUM LENGTH (MM)	WEIGHT (KG)
Z55	9001-10055	1400	1420	0.101
Z56	9001-10056	1422	1444	0.100
Z57	9001-10057	1450	1470	0.100
Z58	9001-10058	1475	1497	0.100
Z59	9001-10059	1500	1520	0.110
Z60	9001-10060	1524	1546	0.110
Z61	9001-10061	1550	1572	0.110
Z62	9001-10062	1575	1597	0.110
Z63	9001-10063	1595	1622	0.110
Z63.5	9001-20635	1600	1630	0.110
Z64	9001-10064	1626	1648	0.110
Z65	9001-10065	1651	1673	0.120
Z66	9001-10066	1675	1697	0.120
Z67	9001-10067	1700	1720	0.120
Z68	9001-10068	1725	1747	0.120
Z69	9001-10069	1750	1772	0.120
Z70	9001-10070	1775	1797	0.130
Z71	9001-10071	1800	1820	0.130
Z73	9001-10073	1850	1872	0.130
Z75	9001-10075	1900	1920	0.130
Z78	9001-10078	1975	1997	0.140
Z79	9001-10079	2000	2022	0.140
Z83.5	9001-20835	2120	2142	0.150
Z88	9001-10088	2240	2262	0.160
Z93	9001-10093	2360	2382	0.170
Z98	9001-10098	2500	2522	0.180

HI POWER

* THE ITEM IS MADE-TO-ORDER, NOT IN STOCK. PLEASE REFER TO GATES E-COMMERCE WEBSITE FOR UPDATED INFORMATION



20 HI-POWER - A

DESCRIPTION	PRODUCT NUMBER	INSIDE LENGTH (MM)	DATUM LENGTH (MM)	WEIGHT (KG)
A18	9002-10018	457	487	0.061
A19	9002-10019	480	510	0.064
A20	9002-10020	508	538	0.067
A21	9002-10021	535	570	0.070
A22	9002-10022	560	595	0.070
A23	9002-10023	590	620	0.071
A23.5	9002-20235	600	630	0.072
A24	9002-10024	615	645	0.074
A24.5	9002-20245	630	655	0.080
A25	9002-10025	650	680	0.078
A26	9002-10026	670	705	0.081
A27	9002-10027	690	720	0.083
A27.5	9002-20275	700	730	0.084
A28	9002-10028	710	745	0.090
A28.5	9002-20285	725	755	0.090
A29.5	9002-20295	750	780	0.090
A30	9002-10030	775	805	0.093
A31	9002-10031	800	825	0.102
A32	9002-10032	825	850	0.105
A32.5	9002-20325	825	855	0.107
A33	9002-10033	850	875	0.108
A34	9002-10034	875	900	0.111
A35	9002-10035	900	925	0.114
A36	9002-10036	925	950	0.118
A37	9002-10037	950	975	0.121
A38	9002-10038	975	1000	0.124
A38.5	9002-20385	975	1005	0.126
A39	9002-10039	1000	1025	0.127
A40	9002-10040	1030	1055	0.130
A40.5	9002-20405	1030	1060	0.133
A41	9002-10041	1050	1080	0.133
A41.5	9002-20415	1060	1090	0.135
A42	9002-10042	1075	1105	0.140
A43	9002-10043	1100	1130	0.140
A44	9002-10044	1125	1155	0.143
A45	9002-10045	1150	1180	0.150
A46	9002-10046	1180	1205	0.149
A46.5	9002-20465	1180	1210	0.151
A47	9002-10047	1200	1230	0.152
A48	9002-10048	1225	1255	0.156
A49	9002-10049	1250	1280	0.159
A50	9002-10050	1275	1310	0.162
A51	9002-10051	1300	1330	0.165
A52	9002-10052	1320	1355	0.168
A53	9002-10053	1350	1385	0.171
A54	9002-10054	1375	1410	0.174
A55	9002-10055	1400	1435	0.178
A56	9002-10056	1430	1460	0.181
A57	9002-10057	1450	1485	0.184

* THE ITEM IS MADE-TO-ORDER, NOT IN STOCK. PLEASE REFER TO GATES E-COMMERCE WEBSITE FOR UPDATED INFORMATION



20 HI-POWER - A

DESCRIPTION	PRODUCT NUMBER	INSIDE LENGTH (MM)	DATUM LENGTH (MM)	WEIGHT (KG)
A58	9002-10058	1475	1510	0.187
A59	9002-10059	1500	1535	0.190
A60	9002-10060	1525	1560	0.193
A61	9002-10061	1550	1585	0.196
A62	9002-10062	1575	1610	0.200
A63	9002-10063	1600	1635	0.203
A64	9002-10064	1625	1660	0.206
A65	9002-10065	1655	1690	0.209
A66	9002-10066	1680	1715	0.212
A67	9002-10067	1700	1735	0.215
A68	9002-10068	1730	1765	0.219
A69	9002-10069	1760	1790	0.222
A70	9002-10070	1780	1815	0.225
A71	9002-10071	1800	1840	0.228
A72	9002-10072	1830	1865	0.231
A73	9002-10073	1860	1890	0.234
A74	9002-10074	1880	1915	0.237
A75	9002-10075	1900	1940	0.241
A76	9002-10076	1930	1965	0.250
A77	9002-10077	1960	1990	0.247
A78	9002-10078	1980	2020	0.250
A79	9002-10079	2000	2040	0.253
A80	9002-10080	2040	2070	0.256
A81	9002-10081	2060	2095	0.260
A82	9002-10082	2090	2120	0.263
A83	9002-10083	2120	2145	0.270
A83.5	9002-20835	2120	2150	0.270
A84	9002-10084	2140	2170	0.270
A84.5	9002-20845	2150	2180	0.270
A85	9002-10085	2160	2195	0.272
A86	9002-10086	2200	2220	0.280
A87	9002-10087	2215	2245	0.280
A88	9002-10088	2240	2270	0.280
A89	9002-10089	2265	2295	0.290
A90	9002-10090	2300	2325	0.290
A91	9002-10091	2320	2350	0.290
A92	9002-10092	2345	2375	0.300
A93	9002-10093	2360	2400	0.300
A94	9002-10094	2400	2425	0.300
A95	9002-10095	2420	2450	0.310
A96	9002-10096	2440	2475	0.310
A97	9002-10097	2475	2500	0.310
A98	9002-10098	2500	2525	0.320
A100	9002-10100	2540	2575	0.320
A102	9002-10102	2590	2625	0.330
A104	9002-10104	2650	2680	0.340
A105	9002-10105	2670	2705	0.340
A107	9002-10107	2725	2755	0.350
A108	9002-10108	2750	2780	0.350

* THE ITEM IS MADE-TO-ORDER, NOT IN STOCK. PLEASE REFER TO GATES E-COMMERCE WEBSITE FOR UPDATED INFORMATION

HI POWER



20 HI-POWER - A

DESCRIPTION	PRODUCT NUMBER	INSIDE LENGTH (MM)	DATUM LENGTH (MM)	WEIGHT (KG)
A110	9002-10110	2800	2830	0.360
A112	9002-10112	2850	2880	0.360
A114	9002-10114	2896	2926	0.370
A116	9002-10116	2946	2976	0.370
A118	9002-10118	3000	3035	0.380
A120	9002-10120	3050	3085	0.390
A124	9002-10124	3150	3185	0.400
A128	9002-10128	3250	3290	0.410
A130	9002-10130	3310	3340	0.420
A132	9002-10132	3350	3380	0.420
A134	9002-10134	3410	3440	0.430
A136	9002-10136	3455	3490	0.440
A140	9002-10140	3550	3590	0.450
A144	9002-10144	3660	3695	0.460
A147	9002-10147	3750	3770	0.470
A148	9002-10148	3750	3780	0.470
A158	9002-10158	4000	4050	0.510
A167	9002-10167	4250	4280	0.540
A173	9002-10173	4400	4430	0.560
A180	9002-10180	4575	4610	0.580
A187	9002-10187	4750	4780	0.600
A195	9002-10195*	4915	4950	0.620
A197	9002-10197	5000	5030	0.630

* THE ITEM IS MADE-TO-ORDER, NOT IN STOCK. PLEASE REFER TO GATES E-COMMERCE WEBSITE FOR UPDATED INFORMATION



21 HI-POWER - B

DESCRIPTION	PRODUCT NUMBER	INSIDE LENGTH (MM)	DATUM LENGTH (MM)	WEIGHT (KG)
B25	9003-10025	650	695	0.139
B26	9003-10026	670	710	0.142
B27	9003-10027	695	735	0.147
B27.5	9003-20275	710	745	0.149
B28	9003-10028	725	770	0.154
B29	9003-10029	750	795	0.159
B30	9003-10030	775	815	0.164
B31	9003-10031	800	845	0.169
B32	9003-10032	825	870	0.174
B32.5	9003-20325	825	865	0.180
B33	9003-10033	850	895	0.179
B34	9003-10034	875	920	0.184
B35	9003-10035	900	940	0.195
B36	9003-10036	925	965	0.199
B37	9003-10037	950	990	0.205
B38	9003-10038	975	1015	0.211
B38.5	9003-20385	975	1015	0.212
B39	9003-10039	1000	1040	0.215
B40	9003-10040	1030	1065	0.220
B41	9003-10041	1060	1095	0.226
B42	9003-10042	1075	1120	0.232
B43	9003-10043	1100	1145	0.236
B44	9003-10044	1120	1170	0.242
B45	9003-10045	1150	1195	0.247
B46	9003-10046	1180	1220	0.253
B47	9003-10047	1200	1245	0.258
B48	9003-10048	1225	1270	0.263
B49	9003-10049	1250	1295	0.268
B50	9003-10050	1275	1320	0.274
B51	9003-10051	1300	1345	0.279
B52	9003-10052	1335	1370	0.284
B53	9003-10053	1360	1395	0.289
B54	9003-10054	1385	1425	0.295
B55	9003-10055	1400	1450	0.300
B56	9003-10056	1435	1475	0.305
B57	9003-10057	1460	1500	0.311
B58	9003-10058	1485	1525	0.316
B59	9003-10059	1500	1550	0.321
B60	9003-10060	1535	1575	0.326
B61	9003-10061	1560	1600	0.332
B62	9003-10062	1585	1625	0.337
B63	9003-10063	1600	1650	0.342
B64	9003-10064	1625	1675	0.348
B65	9003-10065	1650	1700	0.353
B66	9003-10066	1700	1730	0.358
B67	9003-10067	1725	1755	0.363
B68	9003-10068	1750	1780	0.369
B69	9003-10069	1765	1805	0.374
B69.5	9003-20695	1760	1800	0.370

* THE ITEM IS MADE-TO-ORDER, NOT IN STOCK. PLEASE REFER TO GATES E-COMMERCE WEBSITE FOR UPDATED INFORMATION

21 HI-POWER - B

DESCRIPTION	PRODUCT NUMBER	INSIDE LENGTH (MM)	DATUM LENGTH (MM)	WEIGHT (KG)
B70	9003-10070	1800	1830	0.379
B71	9003-10071	1815	1855	0.385
B72	9003-10072	1850	1880	0.390
B73	9003-10073	1865	1905	0.395
B74	9003-10074	1900	1930	0.400
B75	9003-10075	1915	1955	0.406
B76	9003-10076	1950	1980	0.411
B77	9003-10077	1970	2005	0.416
B78	9003-10078	2000	2030	0.421
B79	9003-10079	2020	2060	0.430
B80	9003-10080	2040	2085	0.432
B81	9003-10081	2060	2110	0.437
B82	9003-10082	2100	2135	0.443
B83	9003-10083	2120	2160	0.448
B84	9003-10084	2145	2185	0.450
B85	9003-10085	2160	2210	0.458
B86	9003-10086	2200	2235	0.464
B87	9003-10087	2220	2260	0.470
B88	9003-10088	2240	2285	0.470
B89	9003-10089	2270	2310	0.480
B90	9003-10090	2300	2335	0.484
B91	9003-10091	2325	2365	0.490
B92	9003-10092	2360	2390	0.490
B93	9003-10093	2375	2415	0.500
B94	9003-10094	2400	2440	0.500
B95	9003-10095	2425	2465	0.510
B96	9003-10096	2450	2490	0.520
B97	9003-10097	2475	2515	0.520
B98	9003-10098	2500	2540	0.530
B99	9003-10099	2525	2565	0.530
B100	9003-10100	2540	2590	0.540
B101	9003-10101	2565	2605	0.540
B102	9003-10102	2600	2640	0.550
B103	9003-10103	2625	2665	0.550
B104	9003-10104	2650	2695	0.560
B105	9003-10105	2680	2720	0.560
B106	9003-10106	2700	2745	0.570
B107	9003-10107	2718	2758	0.570
B108	9003-10108	2755	2795	0.580
B110	9003-10110	2800	2845	0.590
B112	9003-10112	2850	2895	0.600
B114	9003-10114	2900	2945	0.610
B115	9003-10115	2921	2961	0.610
B116	9003-10116	2950	3000	0.620
B118	9003-10118	3000	3050	0.630
B120	9003-10120	3060	3100	0.640
B122	9003-10122	3100	3150	0.650
B124	9003-10124	3150	3200	0.660
B126	9003-10126	3200	3240	0.670

* THE ITEM IS MADE-TO-ORDER, NOT IN STOCK. PLEASE REFER TO GATES E-COMMERCE WEBSITE FOR UPDATED INFORMATION



21 HI-POWER - B

DESCRIPTION	PRODUCT NUMBER	INSIDE LENGTH (MM)	DATUM LENGTH (MM)	WEIGHT (KG)
B128	9003-10128	3250	3300	0.680
B130	9003-10130	3310	3350	0.690
B131	9003-10131	3350	3380	0.700
B132	9003-10132	3350	3390	0.700
B133	9003-10133	3390	3430	0.710
B134	9003-10134	3415	3455	0.720
B136	9003-10136	3460	3505	0.730
B138	9003-10138	3505	3545	0.730
B140	9003-10140	3550	3610	0.750
B142	9003-10142	3600	3640	0.750
B144	9003-10144	3670	3710	0.770
B146	9003-10146	3700	3740	0.770
B147	9003-10147	3750	3785	0.780
B148	9003-10148	3770	3810	0.790
B150	9003-10150	3810	3850	0.800
B151	9003-10151	3850	3890	0.810
B152	9003-10152	3870	3910	0.810
B154	9003-10154	3912	3952	0.820
B155	9003-10155	3950	3990	0.830
B156	9003-10156	3962	4002	0.830
B157	9003-10157	4000	4040	0.840
B158	9003-10158	4025	4065	0.840
B160	9003-10160	4064	4104	0.850
B162	9003-10162	4125	4165	0.860
B165	9003-10165	4200	4240	0.880
B167	9003-10167	4250	4295	0.890
B173	9003-10173	4400	4445	0.920
B175	9003-10175	4450	4495	0.930
B177	9003-10177	4500	4545	0.940
B180	9003-10180	4580	4625	0.960
B186	9003-10186	4750	4775	0.990
B187	9003-10187	4750	4790	0.990
B195	9003-10195	4960	5005	1.040
B196	9003-10196	5000	5030	1.040
B197	9003-10197	5000	5040	1.040
B204	9003-10204	5200	5235	1.080
B208	9003-10208	5300	5335	1.110
B210	9003-10210	5345	5385	1.120
B220	9003-10220	5600	5640	1.170
B221	9003-10221	5600	5625	1.170
B225	9003-10225	5690	5730	1.190
B236	9003-10236	6000	6040	1.250
B240	9003-10240	6070	6110	1.270
B248	9003-10248	6300	6340	1.310
B249	9003-10249	6300	6340	1.310
B264	9003-10264	6700	6740	1.400
B270	9003-10270	6830	6870	1.420
B276	9003-10276	7000	7040	1.460
B280	9003-10280	7100	7140	1.480
B300	9003-10300	7620	7635	1.580

* THE ITEM IS MADE-TO-ORDER, NOT IN STOCK. PLEASE REFER TO GATES E-COMMERCE WEBSITE FOR UPDATED INFORMATION



22 HI-POWER - C

DESCRIPTION	PRODUCT NUMBER	INSIDE LENGTH (MM)	DATUM LENGTH (MM)	WEIGHT (KG)
C42	9004-10042	1080	1145	0.428
C43	9004-10043	1100	1165	0.435
C46	9004-10046	1180	1245	0.406
C47	9004-10047	1200	1258	0.399
C48	9004-10048	1230	1290	0.456
C49	9004-10049	1250	1320	0.494
C51	9004-10051	1320	1370	0.512
C52	9004-10052	1320	1378	0.500
C53	9004-10053	1350	1420	0.530
C54	9004-10054	1375	1445	0.520
C55	9004-10055	1400	1470	0.550
C56	9004-10056	1425	1483	0.530
C57	9004-10057	1450	1508	0.540
C58	9004-10058	1475	1533	0.550
C59	9004-10059	1500	1570	0.589
C60	9004-10060	1525	1595	0.590
C61	9004-10061	1550	1608	0.580
C62	9004-10062	1600	1650	0.580
C63	9004-10063	1600	1658	0.590
C65	9004-10065	1665	1725	0.610
C66	9004-10066	1700	1750	0.620
C67	9004-10067	1700	1758	0.630
C68	9004-10068	1750	1800	0.674
C69	9004-10069	1750	1808	0.650
C70	9004-10070	1800	1850	0.650
C71	9004-10071	1830	1875	0.660
C72	9004-10072	1840	1900	0.670
C73	9004-10073*	1854	1912	0.690
C74	9004-10074	1900	1950	0.690
C75	9004-10075	1920	1980	0.700
C76	9004-10076	1930	1988	0.710
C77	9004-10077	1956	2014	0.730
C78	9004-10078	2000	2055	0.750
C79	9004-10079	2000	2058	0.740
C80	9004-10080	2032	2090	0.760
C81	9004-10081	2070	2130	0.770
C82	9004-10082	2100	2155	0.780
C83	9004-10083	2120	2180	0.780
C84	9004-10084	2134	2192	0.790
C85	9004-10085	2170	2230	0.800
C86	9004-10086	2184	2242	0.810
C87	9004-10087	2210	2268	0.820
C88	9004-10088	2240	2310	0.840
C89	9004-10089	2261	2319	0.840
C90	9004-10090	2300	2360	0.860
C92	9004-10092	2360	2410	0.880
C93	9004-10093	2375	2435	0.870
C94	9004-10094	2388	2446	0.890
C95	9004-10095	2425	2485	0.900

* THE ITEM IS MADE-TO-ORDER, NOT IN STOCK. PLEASE REFER TO GATES E-COMMERCE WEBSITE FOR UPDATED INFORMATION



22 HI-POWER - C

DESCRIPTION	PRODUCT NUMBER	INSIDE LENGTH (MM)	DATUM LENGTH (MM)	WEIGHT (KG)
C96	9004-10096	2460	2510	0.910
C97	9004-10097	2475	2535	0.910
C98	9004-10098	2500	2560	0.910
C99	9004-10099	2525	2590	0.920
C100	9004-10100	2560	2615	0.950
C101	9004-10101*	2580	2640	0.940
C102	9004-10102	2600	2665	0.970
C104	9004-10104	2650	2715	0.970
C105	9004-10105	2675	2740	1.000
C106	9004-10106	2692	2750	1.000
C108	9004-10108	2750	2815	1.020
C110	9004-10110	2800	2865	1.050
C112	9004-10112	2860	2920	1.070
C114	9004-10114	2896	2954	1.080
C115	9004-10115	2935	2995	1.100
C116	9004-10116	2965	3020	1.110
C117	9004-10117	2965	3023	1.100
C118	9004-10118	3000	3070	1.110
C120	9004-10120	3050	3120	1.120
C122	9004-10122	3099	3157	1.150
C124	9004-10124	3150	3225	1.160
C125	9004-10125*	3175	3250	1.170
C126	9004-10126	3200	3258	1.190
C128	9004-10128	3250	3325	1.200
C130	9004-10130	3300	3375	1.230
C132	9004-10132	3350	3425	1.230
C134	9004-10134	3415	3475	1.250
C136	9004-10136	3450	3525	1.270
C138	9004-10138	3505	3563	1.300
C140	9004-10140	3550	3630	1.310
C142	9004-10142	3607	3665	1.340
C144	9004-10144	3670	3730	1.340
C146	9004-10146	3700	3758	1.370
C147	9004-10147	3750	3805	1.370
C148	9004-10148	3750	3808	1.390
C150	9004-10150	3810	3868	1.410
C153	9004-10153	3900	3960	1.430
C158	9004-10158	4000	4085	1.470
C162	9004-10162	4130	4190	1.510
C165	9004-10165	4200	4265	1.540
C166	9004-10166	4216	4274	1.560
C167	9004-10167	4250	4308	1.570
C168	9004-10168	4267	4325	1.580
C170	9004-10170	4318	4376	1.600
C173	9004-10173	4400	4465	1.690
C175	9004-10175	4445	4503	1.650
C177	9004-10177	4500	4570	1.650
C180	9004-10180	4575	4645	1.700
C187	9004-10187	4750	4808	1.720

* THE ITEM IS MADE-TO-ORDER, NOT IN STOCK. PLEASE REFER TO GATES E-COMMERCE WEBSITE FOR UPDATED INFORMATION

HI POWER



22 HI-POWER - C

DESCRIPTION	PRODUCT NUMBER	INSIDE LENGTH (MM)	DATUM LENGTH (MM)	WEIGHT (KG)
C190	9004-10190	4826	4884	1.740
C195	9004-10195	4980	5025	1.790
C197	9004-10197	5000	5058	1.800
C208	9004-10208	5300	5355	1.910
C209	9004-10209*	5309	5367	1.910
C210	9004-10210	5340	5405	1.930
C220	9004-10220	5600	5658	2.020
C222	9004-10222	5600	5660	2.020
C225	9004-10225	5675	5735	2.130
C236	9004-10236	6000	6058	2.290
C238	9004-10238	6000	6065	2.160
C240	9004-10240	6050	6120	2.180
C248	9004-10248*	6250	6325	2.350
C250	9004-10250	6300	6370	2.370
C255	9004-10255	6440	6500	2.450
C264	9004-10264	6700	6758	2.550
C265	9004-10265	6700	6755	2.410
C270	9004-10270	6820	6880	2.560
C280	9004-10280	7100	7135	2.650
C285	9004-10285	7200	7260	2.700
C295	9004-10295	7500	7558	2.850
C300	9004-10300	7580	7640	2.840
C315	9004-10315	8000	8058	3.040
C330	9004-10330	8340	8405	3.130

* THE ITEM IS MADE-TO-ORDER, NOT IN STOCK. PLEASE REFER TO GATES E-COMMERCE WEBSITE FOR UPDATED INFORMATION



23 HI-POWER - D

DESCRIPTION	PRODUCT NUMBER	INSIDE LENGTH (MM)	DATUM LENGTH (MM)	WEIGHT (KG)
D98	9005-10098	2500	2570	1.760
D104	9005-10104	2650	2720	1.860
D110	9005-10110	2800	2875	1.960
D112	9005-02112*	2850	2925	2.550
D120	9005-10120	3050	3130	2.130
D124	9005-10124	3150	3230	2.200
D128	9005-10128	3250	3330	2.270
D137	9005-10137	3480	3560	2.430
D140	9005-10140	3550	3635	2.480
D144	9005-10144	3660	3740	2.550
D158	9005-10158	4000	4095	2.790
D162	9005-10162	4115	4195	2.860
D170	9005-10170	4320	4400	3.000
D173	9005-10173	4400	4475	3.050
D177	9005-10177	4500	4575	3.120
D180	9005-10180	4570	4650	3.170
D187	9005-10187	4750	4830	3.300
D195	9005-10195	4955	5035	3.430
D197	9005-10197	5000	5085	3.470
D204	9005-10204	5180	5260	3.590
D210	9005-10210	5335	5415	3.690
D223	9005-10223	5600	5680	3.880
D240	9005-10240	6035	6115	4.170
D250	9005-10250	6300	6365	4.320
D270	9005-10270	6800	6875	4.690
D282	9005-10282	7100	7180	4.900
D298	9005-10298	7500	7585	5.180
D300	9005-10300	7555	7635	5.210
D316	9005-10316*	7967	8042	5.490
D315	9005-02315*	8007	8082	6.360
D330	9005-10330	8320	8400	5.730
D345	9005-02345*	8770	8845	6.910
D360	9005-10360	9080	9160	6.250
D390	9005-02390*	9910	9982	7.700
D420	9005-02420*	10672	10747	8.220
D441	9005-02441*	11207	11282	8.590
D450	9005-02450*	11435	11510	8.760
D480	9005-02480*	12197	12272	9.330
D540	9005-02540*	13721	13796	10.460
D600	9005-02600*	15246	15321	11.740
D660	9005-02660*	16771	16846	12.750

* THE ITEM IS MADE-TO-ORDER, NOT IN STOCK. PLEASE REFER TO GATES E-COMMERCE WEBSITE FOR UPDATED INFORMATION



24 HI-POWER - E

DESCRIPTION	PRODUCT NUMBER	INSIDE LENGTH (MM)	DATUM LENGTH (MM)	WEIGHT (KG)
E180	9006-02180*	4574	4656	4.831
E195	9006-02195*	4955	5037	5.516
E240	9006-02240*	6098	6180	6.790
E270	9006-02270*	6861	6943	7.670
E300	9006-02300*	7623	7705	8.546
E330	9006-02330*	8385	8467	9.400
E360	9006-02360*	9148	9230	10.215
E390	9006-02390*	9910	9992	10.454
E420	9006-02420*	10672	10754	11.946
E540	9006-02540*	13721	13803	14.520
E600	9006-02600*	15246	15328	34.970

25 DELTA CLASSIC - Z

DESCRIPTION	PRODUCT NUMBER	INSIDE LENGTH (MM)	DATUM LENGTH (MM)	WEIGHT (KG)
Z16DELTA	9620-60160	413	435	0.029
Z17.5DELTA	9620-60175	438	460	0.030
Z18.5DELTA	9620-60185	478	500	0.026
Z19.5DELTA	9620-60195	493	515	0.027
Z20DELTA	9620-60200	508	530	0.028
Z20.5DELTA	9620-60205	521	543	0.028
Z21DELTA	9620-60210	533	555	0.029
Z22.5DELTA	9620-60225	568	590	0.037
Z23DELTA	9620-60230	578	600	0.038
Z24DELTA	9620-60240	608	630	0.033
Z25DELTA	9620-60250	635	657	0.041
Z25.5DELTA	9620-60255	648	670	0.035
Z26.5DELTA	9620-60265	668	690	0.045
Z27DELTA	9620-60270	688	710	0.037
Z28DELTA	9620-60280	703	725	0.047
Z29DELTA	9620-60290	733	755	0.049
Z30DELTA	9620-60300	765	787	0.041
Z30.5DELTA	9620-60305	778	800	0.042
Z31DELTA	9620-60310	788	810	0.051
Z32.5DELTA	9620-60325	828	850	0.044
Z33.5DELTA	9620-60335	853	875	0.046
Z34.5DELTA	9620-60345	878	900	0.055
Z36DELTA	9620-60360	913	935	0.059
Z36.5DELTA	9620-60365	928	950	0.061
Z37.5DELTA	9620-60375	948	970	0.064
Z38.5DELTA	9620-60385	978	1000	0.052
Z39.5DELTA	9620-60395	998	1020	0.065
Z41DELTA	9620-60410	1038	1060	0.055
Z41.5DELTA	9620-60415	1050	1072	0.067
Z43DELTA	9620-60430	1098	1120	0.058

* THE ITEM IS MADE-TO-ORDER, NOT IN STOCK. PLEASE REFER TO GATES E-COMMERCE WEBSITE FOR UPDATED INFORMATION



25 DELTA CLASSIC - Z

DESCRIPTION	PRODUCT NUMBER	INSIDE LENGTH (MM)	DATUM LENGTH (MM)	WEIGHT (KG)
Z44DELTA	9620-60440	1123	1145	0.060
Z45DELTA	9620-60450	1143	1165	0.074
Z45.5DELTA	9620-60455	1158	1180	0.061
Z46DELTA	9620-60460	1168	1190	0.076
Z47DELTA	9620-60470	1193	1215	0.078
Z48DELTA	9620-60480	1223	1245	0.080
Z48.5DELTA	9620-60485	1228	1250	0.074
Z49DELTA	9620-60490	1245	1267	0.066
Z50DELTA	9620-60500	1273	1295	0.076
Z51DELTA	9620-60510	1298	1320	0.069
Z52DELTA	9620-60520	1318	1340	0.082
Z53DELTA	9620-60530	1348	1370	0.084
Z54DELTA	9620-60540	1378	1400	0.083
Z55DELTA	9620-60550	1398	1420	0.090
Z57DELTA	9620-60570	1448	1470	0.087
Z58DELTA	9620-60580	1478	1500	0.089
Z59DELTA	9620-60590	1498	1520	0.090
Z60DELTA	9620-60600	1523	1545	0.080
Z61DELTA	9620-60610	1553	1575	0.093
Z62DELTA	9620-60620	1578	1600	0.094
Z63DELTA	9620-60630	1603	1625	0.096
Z65DELTA	9620-60650	1653	1675	0.099
Z66DELTA	9620-60660	1678	1700	0.100
Z67DELTA	9620-60670	1703	1725	0.102
Z69DELTA	9620-60690	1753	1775	0.105
Z70DELTA	9620-60700	1778	1800	0.106
Z71DELTA	9620-60710	1803	1825	0.108

26 DELTA CLASSIC - A

DESCRIPTION	PRODUCT NUMBER	INSIDE LENGTH (MM)	DATUM LENGTH (MM)	WEIGHT (KG)
A18DELTA	9621-60180	457	487	0.046
A19DELTA	9621-60190	480	510	0.048
A20DELTA	9621-60200	510	540	0.051
A21DELTA	9621-60210	530	560	0.053
A22DELTA	9621-60220	560	590	0.056
A23DELTA	9621-60230	590	620	0.059
A23.5DELTA	9621-60235	600	630	0.059
A24DELTA	9621-60240	610	640	0.060
A25DELTA	9621-60250	640	670	0.063
A26DELTA	9621-60260	670	700	0.066
A27DELTA	9621-60270	690	720	0.068
A27.5DELTA	9621-60275	700	730	0.069
A28DELTA	9621-60280	710	740	0.071
A28.5DELTA	9621-60285	720	750	0.071

* THE ITEM IS MADE-TO-ORDER, NOT IN STOCK. PLEASE REFER TO GATES E-COMMERCE WEBSITE FOR UPDATED INFORMATION



26 DELTA CLASSIC - A

DESCRIPTION	PRODUCT NUMBER	INSIDE LENGTH (MM)	DATUM LENGTH (MM)	WEIGHT (KG)
A29DELTA	9621-60290	735	765	0.072
A29.5DELTA	9621-60295	750	780	0.074
A30DELTA	9621-60300	770	800	0.076
A31DELTA	9621-60310	795	825	0.078
A32DELTA	9621-60320	820	850	0.080
A32.5DELTA	9621-60325	830	860	0.081
A33DELTA	9621-60330	840	870	0.082
A34DELTA	9621-60340	870	900	0.085
A35DELTA	9621-60350	890	920	0.087
A36DELTA	9621-60360	920	950	0.090
A37DELTA	9621-60370	940	970	0.092
A38DELTA	9621-60380	960	990	0.093
A38.5DELTA	9621-60385	970	1000	0.094
A39DELTA	9621-60390	990	1020	0.096
A40DELTA	9621-60400	1010	1040	0.118
A40.5DELTA	9621-60405	1030	1060	0.100
A41DELTA	9621-60410	1040	1070	0.118
A42DELTA	9621-60420	1070	1100	0.126
A43DELTA	9621-60430	1090	1120	0.126
A44DELTA	9621-60440	1120	1150	0.109
A45DELTA	9621-60450	1150	1180	0.131
A46DELTA	9621-60460	1170	1200	0.113
A46.5DELTA	9621-60465	1180	1210	0.114
A47DELTA	9621-60470	1200	1230	0.139
A48DELTA	9621-60480	1220	1250	0.118
A49DELTA	9621-60490	1250	1280	0.147
A50DELTA	9621-60500	1270	1300	0.123
A51DELTA	9621-60510	1300	1330	0.126
A52DELTA	9621-60520	1320	1350	0.148
A53DELTA	9621-60530	1350	1380	0.153
A54DELTA	9621-60540	1370	1400	0.132
A55DELTA	9621-60550	1400	1430	0.135
A56DELTA	9621-60560	1425	1455	0.137
A57DELTA	9621-60570	1450	1480	0.165
A58DELTA	9621-60580	1470	1500	0.142
A59DELTA	9621-60590	1500	1530	0.166
A60DELTA	9621-60600	1520	1550	0.146
A61DELTA	9621-60610	1550	1580	0.178
A62DELTA	9621-60620	1580	1610	0.180
A63DELTA	9621-60630	1610	1640	0.182
A64DELTA	9621-60640	1630	1660	0.181
A65DELTA	9621-60650	1660	1690	0.189
A65.5DELTA	9621-60655	1670	1700	0.187
A66DELTA	9621-60660	1680	1710	0.177
A67DELTA	9621-60670	1710	1740	0.181
A68DELTA	9621-60680	1730	1760	0.198
A69DELTA	9621-60690	1760	1790	0.182
A69.5DELTA	9621-60695	1770	1800	0.182
A70DELTA	9621-60700	1780	1810	0.200

* THE ITEM IS MADE-TO-ORDER, NOT IN STOCK. PLEASE REFER TO GATES E-COMMERCE WEBSITE FOR UPDATED INFORMATION



26 DELTA CLASSIC - A

DESCRIPTION	PRODUCT NUMBER	INSIDE LENGTH (MM)	DATUM LENGTH (MM)	WEIGHT (KG)
A71DELTA	9621-60710	1810	1840	0.207
A72DELTA	9621-60720	1830	1860	0.212
A73DELTA	9621-60730	1860	1890	0.178
A73.5DELTA	9621-60735	1870	1900	0.198
A74DELTA	9621-60740	1890	1920	0.216
A75DELTA	9621-60750	1910	1940	0.183
A76DELTA	9621-60760	1930	1960	0.204
A77DELTA	9621-60770	1960	1990	0.188
A77.5DELTA	9621-60775	1970	2000	0.208
A78DELTA	9621-60780	1980	2010	0.190
A79DELTA	9621-60790	2010	2040	0.193
A80DELTA	9621-60800	2032	2062	0.195
A81DELTA	9621-60810	2060	2090	0.197
A82DELTA	9621-60820	2090	2120	0.200
A83DELTA	9621-60830	2110	2140	0.202
A84DELTA	9621-60840	2140	2170	0.205
A85DELTA	9621-60850	2170	2200	0.244
A86DELTA	9621-60860	2190	2220	0.210
A87DELTA	9621-60870	2210	2240	0.211
A88DELTA	9621-60880	2240	2270	0.250
A89DELTA	9621-60890	2270	2300	0.239
A90DELTA	9621-60900	2290	2320	0.219
A91DELTA	9621-60910	2320	2350	0.267
A92DELTA	9621-60920	2340	2370	0.246
A93DELTA	9621-60930	2370	2400	0.227
A94DELTA	9621-60940	2390	2420	0.228
A95DELTA	9621-60950	2420	2450	0.254
A96DELTA	9621-60960	2450	2480	0.234
A97DELTA	9621-60970	2470	2500	0.236
A98DELTA	9621-60980	2500	2530	0.263
A99DELTA	9621-60990*	2520	2550	0.264
A100DELTA	9621-61000	2540	2570	0.267
A102DELTA	9621-61020	2590	2620	0.272
A103DELTA	9621-61030	2620	2650	0.276
A104DELTA	9621-61040	2650	2680	0.279
A105DELTA	9621-61050	2670	2700	0.282
A107DELTA	9621-61070	2720	2750	0.286
A108DELTA	9621-61080	2745	2775	0.289
A109DELTA	9621-61090	2770	2800	0.291
A110DELTA	9621-61100	2800	2830	0.294
A112DELTA	9621-61120	2850	2880	0.300
A114DELTA	9621-61140	2896	2926	0.304
A115DELTA	9621-61150	2930	2960	0.307
A116DELTA	9621-61160	2950	2980	0.310
A118DELTA	9621-61180	3000	3030	0.315
A120DELTA	9621-61200	3050	3080	0.321
A123DELTA	9621-61230	3120	3150	0.328
A124DELTA	9621-61240	3150	3180	0.331
A128DELTA	9621-61280	3250	3280	0.342

* THE ITEM IS MADE-TO-ORDER, NOT IN STOCK. PLEASE REFER TO GATES E-COMMERCE WEBSITE FOR UPDATED INFORMATION



26 DELTA CLASSIC - A

DESCRIPTION	PRODUCT NUMBER	INSIDE LENGTH (MM)	DATUM LENGTH (MM)	WEIGHT (KG)
A130DELTA	9621-61300	3305	3335	0.347
A132DELTA	9621-61320	3350	3380	0.440
A136DELTA	9621-61360	3455	3485	0.362
A140DELTA	9621-61400	3555	3585	0.373
A144DELTA	9621-61440	3660	3690	0.478
A148DELTA	9621-61480	3750	3780	0.470
A158DELTA	9621-61580	4015	4045	0.421
A167DELTA	9621-61670	4245	4275	0.445
A187DELTA	9621-61870	4750	4780	0.492
A197DELTA	9621-61970	5000	5030	0.643

27 DELTA CLASSIC - B

DESCRIPTION	PRODUCT NUMBER	INSIDE LENGTH (MM)	DATUM LENGTH (MM)	WEIGHT (KG)
B26DELTA	9622-60260	660	700	0.133
B27DELTA	9622-60270	690	730	0.145
B28DELTA	9622-60280	710	750	0.131
B29DELTA	9622-60290	730	770	0.134
B30DELTA	9622-60300	760	800	0.139
B31DELTA	9622-60310	790	830	0.145
B32DELTA	9622-60320	820	860	0.150
B33DELTA	9622-60330	840	880	0.153
B33.5DELTA	9622-60335	850	890	0.155
B34DELTA	9622-60340	865	905	0.158
B35DELTA	9622-60350	890	930	0.176
B35.5DELTA	9622-60355	905	945	0.165
B36DELTA	9622-60360	920	960	0.167
B36.5DELTA	9622-60365	930	970	0.187
B37DELTA	9622-60370	950	990	0.193
B37.5DELTA	9622-60375	960	1000	0.174
B38DELTA	9622-60380	970	1010	0.199
B38.5DELTA	9622-60385	980	1020	0.178
B39DELTA	9622-60390	990	1030	0.180
B40DELTA	9622-60400	1020	1060	0.208
B41DELTA	9622-60410	1040	1080	0.188
B41.5DELTA	9622-60415	1060	1100	0.192
B42DELTA	9622-60420	1070	1110	0.211
B42.5DELTA	9622-60425	1080	1120	0.195
B43DELTA	9622-60430	1090	1130	0.221
B43.5DELTA	9622-60435	1105	1145	0.200
B44DELTA	9622-60440	1120	1160	0.202
B45DELTA	9622-60450	1150	1190	0.225
B46DELTA	9622-60460	1170	1210	0.231
B47DELTA	9622-60470	1200	1240	0.235
B47.5DELTA	9622-60475	1210	1250	0.241

* THE ITEM IS MADE-TO-ORDER, NOT IN STOCK. PLEASE REFER TO GATES E-COMMERCE WEBSITE FOR UPDATED INFORMATION



27 DELTA CLASSIC - B

DESCRIPTION	PRODUCT NUMBER	INSIDE LENGTH (MM)	DATUM LENGTH (MM)	WEIGHT (KG)
B48DELTA	9622-60480	1220	1260	0.240
B49DELTA	9622-60490	1250	1290	0.247
B50DELTA	9622-60500	1280	1320	0.230
B51DELTA	9622-60510	1300	1340	0.234
B52DELTA	9622-60520	1330	1370	0.252
B53DELTA	9622-60530	1350	1390	0.242
B54DELTA	9622-60540	1370	1410	0.269
B55DELTA	9622-60550	1400	1440	0.251
B56DELTA	9622-60560	1420	1460	0.286
B57DELTA	9622-60570	1450	1490	0.280
B57.5DELTA	9622-60575	1460	1500	0.261
B58DELTA	9622-60580	1470	1510	0.288
B59DELTA	9622-60590	1500	1540	0.292
B60DELTA	9622-60600	1520	1560	0.296
B61DELTA	9622-60610	1550	1590	0.308
B61.5DELTA	9622-60615	1560	1600	0.309
B62DELTA	9622-60620	1580	1620	0.282
B63DELTA	9622-60630	1600	1640	0.286
B64DELTA	9622-60640	1630	1670	0.291
B65DELTA	9622-60650	1660	1700	0.296
B66DELTA	9622-60660	1680	1720	0.325
B67DELTA	9622-60670	1700	1740	0.339
B68DELTA	9622-60680	1730	1770	0.309
B69DELTA	9622-60690	1760	1800	0.314
B70DELTA	9622-60700	1780	1820	0.317
B71DELTA	9622-60710	1810	1850	0.322
B72DELTA	9622-60720	1830	1870	0.348
B73DELTA	9622-60730	1860	1900	0.349
B74DELTA	9622-60740	1880	1920	0.358
B75DELTA	9622-60750	1910	1950	0.358
B76DELTA	9622-60760	1930	1970	0.362
B77DELTA	9622-60770	1960	2000	0.386
B78DELTA	9622-60780	1980	2020	0.368
B79DELTA	9622-60790	2010	2050	0.396
B80DELTA	9622-60800	2030	2070	0.361
B81DELTA	9622-60810	2060	2100	0.392
B81.5DELTA	9622-60815	2080	2120	0.409
B82DELTA	9622-60820	2090	2130	0.394
B83DELTA	9622-60830	2110	2150	0.375
B84DELTA	9622-60840	2140	2180	0.380
B85DELTA	9622-60850	2160	2200	0.383
B86DELTA	9622-60860	2190	2230	0.389
B86.5DELTA	9622-60865	2200	2240	0.432
B87DELTA	9622-60870	2210	2250	0.392
B88DELTA	9622-60880	2240	2280	0.397
B89DELTA	9622-60890	2260	2300	0.428
B90DELTA	9622-60900	2290	2330	0.445
B91DELTA	9622-60910	2310	2350	0.434
B92DELTA	9622-60920	2340	2380	0.440

* THE ITEM IS MADE-TO-ORDER, NOT IN STOCK. PLEASE REFER TO GATES E-COMMERCE WEBSITE FOR UPDATED INFORMATION

27 DELTA CLASSIC - B

DESCRIPTION	PRODUCT NUMBER	INSIDE LENGTH (MM)	DATUM LENGTH (MM)	WEIGHT (KG)
B93DELTA	9622-60930	2360	2400	0.418
B94DELTA	9622-60940	2380	2420	0.449
B95DELTA	9622-60950	2410	2450	0.458
B96DELTA	9622-60960	2440	2480	0.462
B97DELTA	9622-60970	2460	2500	0.468
B98DELTA	9622-60980	2490	2530	0.489
B99DELTA	9622-60990	2520	2560	0.494
B100DELTA	9622-61000	2540	2580	0.499
B101DELTA	9622-61010	2570	2610	0.504
B102DELTA	9622-61020	2590	2630	0.509
B103DELTA	9622-61030	2610	2650	0.512
B104DELTA	9622-61040	2640	2680	0.518
B105DELTA	9622-61050	2660	2700	0.524
B106DELTA	9622-61060	2700	2740	0.529
B107DELTA	9622-61070*	2725	2765	0.533
B108DELTA	9622-61080	2750	2790	0.538
B108.5DELTA	9622-61085	2760	2800	0.540
B110DELTA	9622-61100	2800	2840	0.548
B112DELTA	9622-61120	2850	2890	0.558
B114DELTA	9622-61140	2900	2940	0.567
B115DELTA	9622-61150	2925	2965	0.572
B116DELTA	9622-61160	2950	2990	0.577
B116.5DELTA	9622-61165	2960	3000	0.579
B118DELTA	9622-61180	3000	3040	0.587
B120DELTA	9622-61200	3050	3090	0.597
B122.5DELTA	9622-61225	3110	3150	0.608
B124DELTA	9622-61240	3150	3190	0.616
B126DELTA	9622-61260	3200	3240	0.667
B128DELTA	9622-61280	3250	3290	0.687
B130DELTA	9622-61300	3310	3350	0.700
B132DELTA	9622-61320	3360	3400	0.655
B134DELTA	9622-61340	3410	3450	0.666
B136DELTA	9622-61360	3460	3500	0.710
B138DELTA	9622-61380	3510	3550	0.730
B140DELTA	9622-61400	3560	3600	0.695
B141DELTA	9622-61410*	3585	3625	0.699
B142DELTA	9622-61420*	3610	3650	0.704
B144DELTA	9622-61440	3660	3700	0.753
B146DELTA	9622-61460	3710	3750	0.724
B147DELTA	9622-61470	3740	3780	0.730
B148DELTA	9622-61480	3760	3800	0.733
B152DELTA	9622-61520	3860	3900	0.754
B154DELTA	9622-61540	3910	3950	0.763
B158DELTA	9622-61580	4020	4060	0.784
B160DELTA	9622-61600*	4070	4110	0.793
B162DELTA	9622-61620	4120	4160	0.829
B167DELTA	9622-61670	4240	4280	0.607
B173DELTA	9622-61730	4400	4440	0.927
B175DELTA	9622-61750	4450	4490	0.930

* THE ITEM IS MADE-TO-ORDER, NOT IN STOCK. PLEASE REFER TO GATES E-COMMERCE WEBSITE FOR UPDATED INFORMATION



27 DELTA CLASSIC - B

DESCRIPTION	PRODUCT NUMBER	INSIDE LENGTH (MM)	DATUM LENGTH (MM)	WEIGHT (KG)
B180DELTA	9622-61800	4570	4610	0.938
B187DELTA	9622-61870	4750	4790	0.970
B192DELTA	9622-61920	4880	4920	0.950
B195DELTA	9622-61950	4960	5000	0.965
B208DELTA	9622-62080*	5280	5320	1.026
B210DELTA	9622-62100	5330	5370	1.085
B240DELTA	9622-62400	6100	6140	1.260
B248DELTA	9622-62480	6300	6340	1.295
B270DELTA	9622-62700	6860	6900	1.410
B280DELTA	9622-62800	7110	7150	1.487

28 DELTA CLASSIC - C

DESCRIPTION	PRODUCT NUMBER	INSIDE LENGTH (MM)	DATUM LENGTH (MM)	WEIGHT (KG)
C43DELTA	9623-60430	1092	1150	0.348
C47DELTA	9623-60470	1192	1250	0.398
C48DELTA	9623-60480	1222	1280	0.407
C49DELTA	9623-60490	1242	1300	0.413
C51DELTA	9623-60510	1292	1350	0.429
C52DELTA	9623-60520	1320	1378	0.438
C53DELTA	9623-60530	1342	1400	0.445
C55DELTA	9623-60550	1392	1450	0.461
C56DELTA	9623-60560	1422	1480	0.471
C57DELTA	9623-60570	1442	1500	0.477
C58DELTA	9623-60580	1472	1530	0.487
C59DELTA	9623-60590	1502	1560	0.496
C60DELTA	9623-60600	1522	1580	0.502
C61DELTA	9623-60610	1542	1600	0.509
C62DELTA	9623-60620	1572	1630	0.518
C63DELTA	9623-60630	1592	1650	0.525
C64DELTA	9623-60640*	1617	1675	0.533
C65DELTA	9623-60650	1642	1700	0.541
C66DELTA	9623-60660	1672	1730	0.550
C67DELTA	9623-60670	1702	1760	0.560
C68DELTA	9623-60680	1727	1785	0.568
C69DELTA	9623-60690	1752	1810	0.576
C70DELTA	9623-60700	1772	1830	0.582
C71DELTA	9623-60710	1802	1860	0.591
C72DELTA	9623-60720	1829	1887	0.600
C72.5DELTA	9623-60725	1842	1900	0.604
C75DELTA	9623-60750	1907	1965	0.625
C76DELTA	9623-60760	1932	1990	0.633
C77DELTA	9623-60770	1952	2010	0.639
C78DELTA	9623-60780	1982	2040	0.649
C80DELTA	9623-60800	2032	2090	0.665

* THE ITEM IS MADE-TO-ORDER, NOT IN STOCK. PLEASE REFER TO GATES E-COMMERCE WEBSITE FOR UPDATED INFORMATION



28 DELTA CLASSIC - C

DESCRIPTION	PRODUCT NUMBER	INSIDE LENGTH (MM)	DATUM LENGTH (MM)	WEIGHT (KG)
C81DELTA	9623-60810	2052	2110	0.671
C82DELTA	9623-60820	2082	2140	0.681
C83DELTA	9623-60830	2102	2160	0.687
C84DELTA	9623-60840	2132	2190	0.696
C85DELTA	9623-60850	2162	2220	0.706
C86DELTA	9623-60860	2182	2240	0.712
C88DELTA	9623-60880	2232	2290	0.728
C89DELTA	9623-60890	2262	2320	0.738
C90DELTA	9623-60900	2282	2340	0.744
C93DELTA	9623-60930	2362	2420	0.770
C94DELTA	9623-60940	2382	2440	0.776
C95DELTA	9623-60950	2412	2470	0.785
C96DELTA	9623-60960	2432	2490	0.792
C97DELTA	9623-60970	2462	2520	0.801
C98DELTA	9623-60980	2492	2550	0.811
C99DELTA	9623-60990	2512	2570	0.817
C100DELTA	9623-61000	2542	2600	0.827
C101DELTA	9623-61010	2562	2620	0.833
C102DELTA	9623-61020	2592	2650	0.843
C103DELTA	9623-61030*	2617	2675	0.851
C104DELTA	9623-61040	2642	2700	0.859
C105DELTA	9623-61050	2662	2720	0.865
C106DELTA	9623-61060	2692	2750	0.875
C108DELTA	9623-61080	2742	2800	0.890
C110DELTA	9623-61100	2792	2850	0.906
C111DELTA	9623-61110*	2817	2875	0.914
C112DELTA	9623-61120	2842	2900	0.922
C114DELTA	9623-61140	2892	2950	0.938
C115DELTA	9623-61150	2922	2980	0.948
C116DELTA	9623-61160	2942	3000	0.954
C117DELTA	9623-61170*	2967	3025	0.962
C118DELTA	9623-61180	2992	3050	0.970
C120DELTA	9623-61200	3042	3100	0.986
C122DELTA	9623-61220	3092	3150	1.002
C124DELTA	9623-61240	3152	3210	1.021
C125DELTA	9623-61250*	3177	3235	1.029
C128DELTA	9623-61280	3252	3310	1.053
C130DELTA	9623-61300	3302	3360	1.068
C132DELTA	9623-61320	3352	3410	1.084
C134DELTA	9623-61340	3402	3460	1.100
C136DELTA	9623-61360	3462	3520	1.119
C140DELTA	9623-61400	3552	3610	1.148
C144DELTA	9623-61440	3652	3710	1.333
C148DELTA	9623-61480	3762	3820	1.407
C153DELTA	9623-61530	3887	3945	1.413
C158DELTA	9623-61580	4002	4060	1.467
C162DELTA	9623-61620	4112	4170	1.487
C165DELTA	9623-61650	4192	4250	1.352
C167DELTA	9623-61670	4242	4300	1.367

* THE ITEM IS MADE-TO-ORDER, NOT IN STOCK. PLEASE REFER TO GATES E-COMMERCE WEBSITE FOR UPDATED INFORMATION



28 DELTA CLASSIC - C

DESCRIPTION	PRODUCT NUMBER	INSIDE LENGTH (MM)	DATUM LENGTH (MM)	WEIGHT (KG)
C170DELTA	9623-61700	4318	4376	1.530
C173DELTA	9623-61730	4392	4450	1.563
C174DELTA	9623-61740*	4417	4475	1.423
C175DELTA	9623-61750	4442	4500	1.593
C177DELTA	9623-61770	4502	4560	1.617
C180DELTA	9623-61800	4572	4630	1.687
C184DELTA	9623-61840*	4672	4730	1.504
C185DELTA	9623-61850*	4702	4760	1.514
C187DELTA	9623-61870	4752	4810	1.690
C190DELTA	9623-61900	4822	4880	1.737
C195DELTA	9623-61950	4952	5010	1.807
C197DELTA	9623-61970	5002	5060	1.609
C200DELTA	9623-62000*	5082	5140	1.635
C204DELTA	9623-62040	5182	5240	1.666
C208DELTA	9623-62080	5282	5340	1.698
C210DELTA	9623-62100	5334	5392	1.715
C220DELTA	9623-62200*	5592	5650	1.797
C221DELTA	9623-62210*	5617	5675	1.805
C222DELTA	9623-62220	5642	5700	1.813
C225DELTA	9623-62250	5712	5770	2.083
C230DELTA	9623-62300*	5842	5900	1.877
C238DELTA	9623-62380	6042	6100	2.143
C240DELTA	9623-62400	6092	6150	2.203
C245DELTA	9623-62450*	6222	6280	2.040
C250DELTA	9623-62500	6352	6410	2.083
C255DELTA	9623-62550*	6477	6535	2.123
C260DELTA	9623-62600*	6602	6660	2.163
C265DELTA	9623-62650	6732	6790	2.207
C270DELTA	9623-62700	6852	6910	2.246
C275DELTA	9623-62750*	6982	7040	2.287
C280DELTA	9623-62800	7112	7170	2.330
C285DELTA	9623-62850*	7242	7300	2.373
C300DELTA	9623-63000*	7622	7680	2.494
C305DELTA	9623-63050*	7747	7805	2.535
C317DELTA	9623-63170*	8052	8110	2.636
C324DELTA	9623-63240*	8232	8290	2.694
C327DELTA	9623-63270*	8307	8365	2.717
C336DELTA	9623-63360*	8532	8590	2.792

* THE ITEM IS MADE-TO-ORDER, NOT IN STOCK. PLEASE REFER TO GATES E-COMMERCE WEBSITE FOR UPDATED INFORMATION



29 DELTA CLASSIC - D

DESCRIPTION	PRODUCT NUMBER	INSIDE LENGTH (MM)	DATUM LENGTH (MM)	WEIGHT (KG)
D79DELTA	9628-60790	2000	2075	1.365
D91DELTA	9628-60910	2300	2375	1.563
D93DELTA	9628-60930	2360	2435	1.602
D96DELTA	9628-60960	2440	2515	1.655
D98DELTA	9628-60980	2500	2575	1.694
D104DELTA	9628-61040	2650	2725	1.793
D110DELTA	9628-61100	2800	2875	1.892
D118DELTA	9628-61180	3000	3075	2.023
D120DELTA	9628-61200	3050	3125	2.056
D124DELTA	9628-61240	3150	3225	2.122
D126DELTA	9628-61260*	3200	3275	2.155
D128DELTA	9628-61280	3250	3325	2.188
D132DELTA	9628-61320	3350	3425	2.254
D136DELTA	9628-61360	3450	3525	1.445
D140DELTA	9628-61400	3550	3625	2.385
D144DELTA	9628-61440	3660	3735	2.553
D148DELTA	9628-61480	3750	3825	2.570
D154DELTA	9628-61540	3925	4000	2.730
D156DELTA	9628-61560*	3960	4035	2.655
D158DELTA	9628-61580	4000	4075	2.790
D162DELTA	9628-61620	4115	4190	2.847
D163DELTA	9628-61630*	4140	4215	2.773
D167DELTA	9628-61670	4250	4325	2.953
D173DELTA	9628-61730	4395	4470	3.040
D177DELTA	9628-61770	4500	4575	3.130
D180DELTA	9628-61800	4570	4645	3.187
D181DELTA	9628-61810	4595	4670	3.073
D187DELTA	9628-61870	4750	4825	3.175
D195DELTA	9628-61950	4953	5028	3.432
D197DELTA	9628-61970	5000	5075	3.339
D208DELTA	9628-62080	5300	5375	3.537
D210DELTA	9628-62100	5335	5410	3.560
D220DELTA	9628-62200	5600	5675	3.870
D225DELTA	9628-62250	5715	5790	3.810
D233DELTA	9628-62330	5925	6000	3.948
D236DELTA	9628-62360	6000	6075	4.150
D240DELTA	9628-62400	6100	6175	4.063
D248DELTA	9628-62480	6300	6375	4.350
D250DELTA	9628-62500	6350	6425	4.228
D255DELTA	9628-62550	6480	6555	4.313
D264DELTA	9628-62640	6700	6775	4.458
D270DELTA	9628-62700	6860	6935	4.650
D280DELTA	9628-62800	7110	7185	4.728
D285DELTA	9628-62850	7240	7315	4.813
D295DELTA	9628-62950	7500	7575	4.984
D300DELTA	9628-63000	7620	7695	5.063
D315DELTA	9628-63150	8000	8075	5.313
D330DELTA	9628-63300	8382	8457	5.565
D335DELTA	9628-63350	8500	8575	5.642

* THE ITEM IS MADE-TO-ORDER, NOT IN STOCK. PLEASE REFER TO GATES E-COMMERCE WEBSITE FOR UPDATED INFORMATION



29 DELTA CLASSIC - D

DESCRIPTION	PRODUCT NUMBER	INSIDE LENGTH (MM)	DATUM LENGTH (MM)	WEIGHT (KG)
D345DELTA	9628-63450	8765	8840	5.817
D354DELTA	9628-63540	9000	9075	5.971
D360DELTA	9628-63600	9145	9220	6.067
D374DELTA	9628-63740	9500	9575	6.300
D390DELTA	9628-63900	9900	9975	6.564
D394DELTA	9628-63940	10000	10075	6.629
D418DELTA	9628-64180	10615	10690	7.034
D441DELTA	9628-64410	11200	11275	7.419
D478DELTA	9628-64780	12140	12215	8.037
D492DELTA	9628-64920	12500	12575	8.274
D540DELTA	9628-65400	13715	13790	9.074
D600DELTA	9628-66000	15240	15315	10.077

30 DELTA NARROW - SPZ

DESCRIPTION	PRODUCT NUMBER	DATUM LENGTH (MM)	WEIGHT (KG)
SPZ562DELTA	9624-60562	562	0.038
SPZ587DELTA	9624-60587	587	0.039
SPZ600DELTA	9624-60600*	600	0.04
SPZ612DELTA	9624-60612	612	0.041
SPZ630DELTA	9624-60630	630	0.042
SPZ637DELTA	9624-60637	637	0.043
SPZ662DELTA	9624-60662	662	0.044
SPZ670DELTA	9624-60670	670	0.045
SPZ687DELTA	9624-60687	687	0.046
SPZ710DELTA	9624-60710	710	0.047
SPZ722DELTA	9624-60722	722	0.048
SPZ737DELTA	9624-60737	737	0.049
SPZ750DELTA	9624-60750	750	0.050
SPZ762DELTA	9624-60762	762	0.051
SPZ772DELTA	9624-60772	772	0.052
SPZ787DELTA	9624-60787	787	0.053
SPZ800DELTA	9624-60800	800	0.053
SPZ812DELTA	9624-60812	812	0.054
SPZ825DELTA	9624-60825	825	0.055
SPZ837DELTA	9624-60837	837	0.056
SPZ850DELTA	9624-60850	850	0.057
SPZ862DELTA	9624-60862	862	0.058
SPZ875DELTA	9624-60875	875	0.058
SPZ887DELTA	9624-60887	887	0.059
SPZ900DELTA	9624-60900	900	0.06
SPZ912DELTA	9624-60912	912	0.061
SPZ925DELTA	9624-60925	925	0.062
SPZ937DELTA	9624-60937	937	0.063
SPZ950DELTA	9624-60950	950	0.063

* THE ITEM IS MADE-TO-ORDER, NOT IN STOCK. PLEASE REFER TO GATES E-COMMERCE WEBSITE FOR UPDATED INFORMATION

30 DELTA NARROW - SPZ

DESCRIPTION	PRODUCT NUMBER	DATUM LENGTH (MM)	WEIGHT (KG)
SPZ962DELTA	9624-60962	962	0.064
SPZ975DELTA	9624-60975	975	0.065
SPZ987DELTA	9624-60987	987	0.066
SPZ1000DELTA	9624-61000	1000	0.067
SPZ1010DELTA	9624-61010*	1010	0.067
SPZ1012DELTA	9624-61012	1012	0.068
SPZ1024DELTA	9624-61024	1024	0.068
SPZ1030DELTA	9624-61030	1030	0.069
SPZ1037DELTA	9624-61037	1037	0.077
SPZ1047DELTA	9624-61047	1047	0.070
SPZ1060DELTA	9624-61060	1060	0.071
SPZ1077DELTA	9624-61077	1077	0.072
SPZ1087DELTA	9624-61087	1087	0.073
SPZ1112DELTA	9624-61112	1112	0.074
SPZ1120DELTA	9624-61120	1120	0.083
SPZ1137DELTA	9624-61137	1137	0.089
SPZ1150DELTA	9624-61150*	1150	0.077
SPZ1162DELTA	9624-61162	1162	0.078
SPZ1180DELTA	9624-61180	1180	0.092
SPZ1187DELTA	9624-61187	1187	0.079
SPZ1202DELTA	9624-61202	1202	0.093
SPZ1212DELTA	9624-61212	1212	0.092
SPZ1237DELTA	9624-61237	1237	0.094
SPZ1250DELTA	9624-61250	1250	0.097
SPZ1262DELTA	9624-61262	1262	0.096
SPZ1270DELTA	9624-61270*	1270	0.085
SPZ1287DELTA	9624-61287	1287	0.086
SPZ1300DELTA	9624-61300*	1300	0.087
SPZ1312DELTA	9624-61312	1312	0.097
SPZ1320DELTA	9624-61320	1320	0.103
SPZ1337DELTA	9624-61337	1337	0.089
SPZ1347DELTA	9624-61347	1347	0.105
SPZ1362DELTA	9624-61362	1362	0.101
SPZ1387DELTA	9624-61387	1387	0.103
SPZ1400DELTA	9624-61400	1400	0.104
SPZ1412DELTA	9624-61412	1412	0.094
SPZ1420DELTA	9624-61420*	1420	0.104
SPZ1437DELTA	9624-61437	1437	0.106
SPZ1450DELTA	9624-61450	1450	0.107
SPZ1462DELTA	9624-61462	1462	0.098
SPZ1487DELTA	9624-61487	1487	0.110
SPZ1500DELTA	9624-61500	1500	0.111
SPZ1512DELTA	9624-61512	1512	0.101
SPZ1520DELTA	9624-61520*	1520	0.112
SPZ1537DELTA	9624-61537	1537	0.114
SPZ1550DELTA	9624-61550	1550	0.115
SPZ1562DELTA	9624-61562	1562	0.116
SPZ1587DELTA	9624-61587	1587	0.117
SPZ1600DELTA	9624-61600	1600	0.118

* THE ITEM IS MADE-TO-ORDER, NOT IN STOCK. PLEASE REFER TO GATES E-COMMERCE WEBSITE FOR UPDATED INFORMATION



30 DELTA NARROW - SPZ

DESCRIPTION	PRODUCT NUMBER	DATUM LENGTH (MM)	WEIGHT (KG)
SPZ1612DELTA	9624-61612	1612	0.119
SPZ1620DELTA	9624-61620*	1620	0.119
SPZ1637DELTA	9624-61637	1637	0.121
SPZ1650DELTA	9624-61650	1650	0.122
SPZ1662DELTA	9624-61662	1662	0.123
SPZ1687DELTA	9624-61687	1687	0.125
SPZ1700DELTA	9624-61700	1700	0.126
SPZ1737DELTA	9624-61737	1737	0.129
SPZ1750DELTA	9624-61750	1750	0.13
SPZ1762DELTA	9624-61762	1762	0.13
SPZ1787DELTA	9624-61787	1787	0.132
SPZ1800DELTA	9624-61800	1800	0.133
SPZ1812DELTA	9624-61812	1812	0.134
SPZ1837DELTA	9624-61837	1837	0.136
SPZ1850DELTA	9624-61850	1850	0.137
SPZ1862DELTA	9624-61862	1862	0.138
SPZ1887DELTA	9624-61887	1887	0.140
SPZ1900DELTA	9624-61900	1900	0.141
SPZ1937DELTA	9624-61937	1937	0.143
SPZ1950DELTA	9624-61950	1950	0.143
SPZ1987DELTA	9624-61987	1987	0.147
SPZ2000DELTA	9624-62000	2000	0.148
SPZ2030DELTA	9624-62030*	2030	0.149
SPZ2037DELTA	9624-62037	2037	0.136
SPZ2060DELTA	9624-62060	2060	0.152
SPZ2120DELTA	9624-62120	2120	0.157
SPZ2137DELTA	9624-62137	2137	0.158
SPZ2180DELTA	9624-62180	2180	0.161
SPZ2187DELTA	9624-62187	2187	0.162
SPZ2240DELTA	9624-62240	2240	0.166
SPZ2287DELTA	9624-62287	2287	0.169
SPZ2300DELTA	9624-62300*	2300	0.169
SPZ2360DELTA	9624-62360	2360	0.175
SPZ2437DELTA	9624-62437*	2437	0.179
SPZ2500DELTA	9624-62500	2500	0.185
SPZ2650DELTA	9624-62650	2650	0.196
SPZ2800DELTA	9624-62800	2800	0.207
SPZ3000DELTA	9624-63000	3000	0.222
SPZ3150DELTA	9624-63150	3150	0.233
SPZ3350DELTA	9624-63350	3350	0.248
SPZ3550DELTA	9624-63550	3550	0.263

* THE ITEM IS MADE-TO-ORDER, NOT IN STOCK. PLEASE REFER TO GATES E-COMMERCE WEBSITE FOR UPDATED INFORMATION



31 DELTA NARROW - SPA

DESCRIPTION	PRODUCT NUMBER	DATUM LENGTH (MM)	WEIGHT (KG)
SPA732DELTA	9625-60732	732	0.094
SPA757DELTA	9625-60757	757	0.090
SPA782DELTA	9625-60782	782	0.100
SPA800DELTA	9625-60800	800	0.102
SPA825DELTA	9625-60825	825	0.095
SPA832DELTA	9625-60832	832	0.107
SPA850DELTA	9625-60850	850	0.109
SPA857DELTA	9625-60857	857	0.110
SPA875DELTA	9625-60875	875	0.112
SPA900DELTA	9625-60900	900	0.115
SPA932DELTA	9625-60932	932	0.119
SPA950DELTA	9625-60950	950	0.114
SPA975DELTA	9625-60975	975	0.125
SPA1000DELTA	9625-61000	1000	0.128
SPA1007DELTA	9625-61007	1007	0.117
SPA1030DELTA	9625-61030	1030	0.132
SPA1032DELTA	9625-61032	1032	0.132
SPA1050DELTA	9625-61050*	1050	0.135
SPA1057DELTA	9625-61057	1057	0.135
SPA1060DELTA	9625-61060*	1060	0.136
SPA1082DELTA	9625-61082	1082	0.139
SPA1100DELTA	9625-61100*	1100	0.141
SPA1107DELTA	9625-61107	1107	0.142
SPA1120DELTA	9625-61120	1120	0.135
SPA1132DELTA	9625-61132	1132	0.145
SPA1150DELTA	9625-61150	1150	0.147
SPA1157DELTA	9625-61157	1157	0.148
SPA1162DELTA	9625-61162*	1162	0.149
SPA1180DELTA	9625-61180	1180	0.140
SPA1187DELTA	9625-61187*	1187	0.152
SPA1200DELTA	9625-61200*	1200	0.154
SPA1207DELTA	9625-61207	1207	0.155
SPA1220DELTA	9625-61220*	1220	0.156
SPA1232DELTA	9625-61232	1232	0.158
SPA1250DELTA	9625-61250	1250	0.150
SPA1257DELTA	9625-61257	1257	0.197
SPA1272DELTA	9625-61272	1272	0.149
SPA1285DELTA	9625-61285	1285	0.151
SPA1287DELTA	9625-61287*	1287	0.165
SPA1300DELTA	9625-61300*	1300	0.153
SPA1307DELTA	9625-61307	1307	0.167
SPA1320DELTA	9625-61320	1320	0.155
SPA1332DELTA	9625-61332	1332	0.171
SPA1357DELTA	9625-61357	1357	0.155
SPA1360DELTA	9625-61360	1360	0.174
SPA1382DELTA	9625-61382	1382	0.177
SPA1400DELTA	9625-61400	1400	0.179
SPA1407DELTA	9625-61407	1407	0.180
SPA1425DELTA	9625-61425	1425	0.167

* THE ITEM IS MADE-TO-ORDER, NOT IN STOCK. PLEASE REFER TO GATES E-COMMERCE WEBSITE FOR UPDATED INFORMATION



31 DELTA NARROW - SPA

DESCRIPTION	PRODUCT NUMBER	DATUM LENGTH (MM)	WEIGHT (KG)
SPA1432DELTA	9625-61432	1432	0.169
SPA1450DELTA	9625-61450	1450	0.178
SPA1482DELTA	9625-61482	1482	0.190
SPA1500DELTA	9625-61500	1500	0.176
SPA1520DELTA	9625-61520*	1520	0.179
SPA1532DELTA	9625-61532	1532	0.196
SPA1550DELTA	9625-61550	1550	0.182
SPA1557DELTA	9625-61557*	1557	0.183
SPA1582DELTA	9625-61582	1582	0.203
SPA1600DELTA	9625-61600	1600	0.188
SPA1620DELTA	9625-61620*	1620	0.190
SPA1632DELTA	9625-61632	1632	0.187
SPA1637DELTA	9625-61637*	1637	0.210
SPA1650DELTA	9625-61650	1650	0.191
SPA1657DELTA	9625-61657	1657	0.195
SPA1675DELTA	9625-61675*	1675	0.197
SPA1682DELTA	9625-61682	1682	0.193
SPA1700DELTA	9625-61700	1700	0.200
SPA1707DELTA	9625-61707	1707	0.219
SPA1732DELTA	9625-61732	1732	0.203
SPA1750DELTA	9625-61750	1750	0.205
SPA1757DELTA	9625-61757	1757	0.206
SPA1782DELTA	9625-61782	1782	0.208
SPA1787DELTA	9625-61787*	1787	0.210
SPA1800DELTA	9625-61800	1800	0.208
SPA1832DELTA	9625-61832	1832	0.214
SPA1837DELTA	9625-61837*	1837	0.216
SPA1857DELTA	9625-61857	1857	0.217
SPA1882DELTA	9625-61882	1882	0.220
SPA1900DELTA	9625-61900	1900	0.225
SPA1932DELTA	9625-61932	1932	0.226
SPA1957DELTA	9625-61957	1957	0.229
SPA1982DELTA	9625-61982	1982	0.232
SPA2000DELTA	9625-62000	2000	0.233
SPA2032DELTA	9625-62032	2032	0.238
SPA2057DELTA	9625-62057	2057	0.241
SPA2060DELTA	9625-62060	2060	0.264
SPA2082DELTA	9625-62082	2082	0.244
SPA2120DELTA	9625-62120	2120	0.246
SPA2132DELTA	9625-62132	2132	0.249
SPA2182DELTA	9625-62182	2182	0.255
SPA2207DELTA	9625-62207	2207	0.258
SPA2232DELTA	9625-62232	2232	0.286
SPA2240DELTA	9625-62240	2240	0.262
SPA2282DELTA	9625-62282	2282	0.267
SPA2300DELTA	9625-62300	2300	0.269
SPA2307DELTA	9625-62307	2307	0.270
SPA2332DELTA	9625-62332	2332	0.273
SPA2360DELTA	9625-62360	2360	0.302

* THE ITEM IS MADE-TO-ORDER, NOT IN STOCK. PLEASE REFER TO GATES E-COMMERCE WEBSITE FOR UPDATED INFORMATION



31 DELTA NARROW - SPA

DESCRIPTION	PRODUCT NUMBER	DATUM LENGTH (MM)	WEIGHT (KG)
SPA2382DELTA	9625-62382	2382	0.279
SPA2430DELTA	9625-62430	2430	0.284
SPA2432DELTA	9625-62432	2432	0.285
SPA2482DELTA	9625-62482	2482	0.290
SPA2500DELTA	9625-62500	2500	0.320
SPA2532DELTA	9625-62532	2532	0.296
SPA2580DELTA	9625-62580	2580	0.302
SPA2582DELTA	9625-62582	2582	0.302
SPA2607DELTA	9625-62607	2607	0.305
SPA2632DELTA	9625-62632	2632	0.308
SPA2650DELTA	9625-62650	2650	0.310
SPA2682DELTA	9625-62682	2682	0.314
SPA2720DELTA	9625-62720	2720	0.318
SPA2732DELTA	9625-62732	2732	0.320
SPA2782DELTA	9625-62782	2782	0.325
SPA2800DELTA	9625-62800	2800	0.328
SPA2832DELTA	9625-62832	2832	0.331
SPA2840DELTA	9625-62840*	2840	0.334
SPA2847DELTA	9625-62847	2847	0.333
SPA2882DELTA	9625-62882	2882	0.337
SPA2900DELTA	9625-62900	2900	0.339
SPA2932DELTA	9625-62932	2932	0.343
SPA2982DELTA	9625-62982	2982	0.349
SPA3000DELTA	9625-63000	3000	0.351
SPA3032DELTA	9625-63032	3032	0.355
SPA3082DELTA	9625-63082	3082	0.361
SPA3150DELTA	9625-63150	3150	0.369
SPA3182DELTA	9625-63182	3182	0.372
SPA3282DELTA	9625-63282	3282	0.384
SPA3350DELTA	9625-63350	3350	0.448
SPA3550DELTA	9625-63550	3550	0.472
SPA3750DELTA	9625-63750	3750	0.507
SPA4000DELTA	9625-64000	4000	0.530
SPA4250DELTA	9625-64250	4250	0.497
SPA4500DELTA	9625-64500	4500	0.527

* THE ITEM IS MADE-TO-ORDER, NOT IN STOCK. PLEASE REFER TO GATES E-COMMERCE WEBSITE FOR UPDATED INFORMATION



32 DELTA NARROW - SPB

DESCRIPTION	PRODUCT NUMBER	DATUM LENGTH (MM)	WEIGHT (KG)
SPB1250DELTA	9626-61250	1250	0.245
SPB1280DELTA	9626-61280	1280	0.275
SPB1320DELTA	9626-61320	1320	0.262
SPB1360DELTA	9626-61360	1360	0.264
SPB1400DELTA	9626-61400	1400	0.274
SPB1450DELTA	9626-61450	1450	0.284
SPB1500DELTA	9626-61500	1500	0.294
SPB1550DELTA	9626-61550	1550	0.303
SPB1600DELTA	9626-61600	1600	0.321
SPB1650DELTA	9626-61650	1650	0.324
SPB1700DELTA	9626-61700	1700	0.342
SPB1720DELTA	9626-61720	1720	0.370
SPB1750DELTA	9626-61750	1750	0.341
SPB1800DELTA	9626-61800	1800	0.359
SPB1850DELTA	9626-61850	1850	0.398
SPB1900DELTA	9626-61900	1900	0.372
SPB1950DELTA	9626-61950	1950	0.419
SPB2000DELTA	9626-62000	2000	0.370
SPB2020DELTA	9626-62020*	2020	0.410
SPB2060DELTA	9626-62060	2060	0.443
SPB2120DELTA	9626-62120	2120	0.438
SPB2180DELTA	9626-62180	2180	0.469
SPB2200DELTA	9626-62200	2200	0.440
SPB2240DELTA	9626-62240	2240	0.450
SPB2250DELTA	9626-62250*	2250	0.457
SPB2300DELTA	9626-62300	2300	0.425
SPB2360DELTA	9626-62360	2360	0.456
SPB2400DELTA	9626-62400*	2400	0.488
SPB2430DELTA	9626-62430	2430	0.522
SPB2450DELTA	9626-62450	2450	0.490
SPB2500DELTA	9626-62500	2500	0.482
SPB2580DELTA	9626-62580	2580	0.555
SPB2600DELTA	9626-62600	2600	0.520
SPB2650DELTA	9626-62650	2650	0.570
SPB2680DELTA	9626-62680*	2680	0.544
SPB2720DELTA	9626-62720	2720	0.585
SPB2800DELTA	9626-62800	2800	0.602
SPB2900DELTA	9626-62900	2900	0.624
SPB3000DELTA	9626-63000	3000	0.645
SPB3150DELTA	9626-63150	3150	0.677
SPB3250DELTA	9626-63250	3250	0.704
SPB3350DELTA	9626-63350	3350	0.740
SPB3450DELTA	9626-63450	3450	0.763
SPB3550DELTA	9626-63550	3550	0.778
SPB3650DELTA	9626-63650	3650	0.800
SPB3750DELTA	9626-63750	3750	0.832
SPB3870DELTA	9626-63870	3870	0.847
SPB4000DELTA	9626-64000	4000	0.878
SPB4120DELTA	9626-64120	4120	0.910

* THE ITEM IS MADE-TO-ORDER, NOT IN STOCK. PLEASE REFER TO GATES E-COMMERCE WEBSITE FOR UPDATED INFORMATION



32 DELTA NARROW - SPB

DESCRIPTION	PRODUCT NUMBER	DATUM LENGTH (MM)	WEIGHT (KG)
SPB4250DELTA	9626-64250	4250	0.932
SPB4370DELTA	9626-64370	4370	0.950
SPB4500DELTA	9626-64500	4500	0.987
SPB4560DELTA	9626-64560	4560	1.003
SPB4620DELTA	9626-64620	4620	1.007
SPB4750DELTA	9626-64750	4750	1.036
SPB4870DELTA	9626-64870	4870	1.047
SPB5000DELTA	9626-65000	5000	1.083
SPB5300DELTA	9626-65300	5300	1.167
SPB5600DELTA	9626-65600	5600	1.223
SPB6000DELTA	9626-66000	6000	1.310
SPB6300DELTA	9626-66300	6300	1.365
SPB6700DELTA	9626-66700	6700	1.457
SPB7100DELTA	9626-67100	7100	1.547
SPB7500DELTA	9626-67500	7500	1.463
SPB8000DELTA	9626-68000	8000	1.735

33 DELTA NARROW - SPC

DESCRIPTION	PRODUCT NUMBER	DATUM LENGTH (MM)	WEIGHT (KG)
SPC10000DELTA	9627-60100	10000	4.070
SPC10600DELTA	9627-60106	10600	4.049
SPC11200DELTA	9627-60112	11200	4.278
SPC2000DELTA	9627-62000	2000	0.800
SPC2120DELTA	9627-62120	2120	0.848
SPC2240DELTA	9627-62240	2240	0.896
SPC2360DELTA	9627-62360	2360	0.944
SPC2500DELTA	9627-62500	2500	1.000
SPC2600DELTA	9627-62600*	2600	0.997
SPC2650DELTA	9627-62650	2650	1.060
SPC2800DELTA	9627-62800	2800	1.120
SPC3000DELTA	9627-63000	3000	1.200
SPC3150DELTA	9627-63150	3150	1.260
SPC3350DELTA	9627-63350	3350	1.300
SPC3550DELTA	9627-63550	3550	1.390
SPC3600DELTA	9627-63600*	3600	1.380
SPC3750DELTA	9627-63750	3750	1.457
SPC4000DELTA	9627-64000	4000	1.528
SPC4250DELTA	9627-64250	4250	1.624
SPC4380DELTA	9627-64380	4380	1.623
SPC4500DELTA	9627-64500	4500	1.773
SPC4750DELTA	9627-64750	4750	1.877
SPC5000DELTA	9627-65000	5000	1.977
SPC5300DELTA	9627-65300	5300	2.025
SPC5600DELTA	9627-65600	5600	2.139

* THE ITEM IS MADE-TO-ORDER, NOT IN STOCK. PLEASE REFER TO GATES E-COMMERCE WEBSITE FOR UPDATED INFORMATION



33 DELTA NARROW - SPC

DESCRIPTION	PRODUCT NUMBER	DATUM LENGTH (MM)	WEIGHT (KG)
SPC5800DELTA	9627-65800*	5800	2.223
SPC6000DELTA	9627-66000	6000	2.400
SPC6300DELTA	9627-66300	6300	2.487
SPC6700DELTA	9627-66700	6700	2.559
SPC7100DELTA	9627-67100	7100	2.875
SPC7500DELTA	9627-67500	7500	2.960
SPC8000DELTA	9627-68000	8000	3.240
SPC8500DELTA	9627-68500	8500	3.405
SPC9000DELTA	9627-69000	9000	3.438
SPC9500DELTA	9627-69500	9500	3.850

* THE ITEM IS MADE-TO-ORDER, NOT IN STOCK. PLEASE REFER TO GATES E-COMMERCE WEBSITE FOR UPDATED INFORMATION



* THE ITEM IS MADE-TO-ORDER, NOT IN STOCK. PLEASE REFER TO GATES E-COMMERCE WEBSITE FOR UPDATED INFORMATION



34 PREDATOR PB 5VP-15JP

DESCRIPTION	DATUM LENGTH (MM)	EFFECTIVE LENGTH (INCH)	WEIGHT/ STRAND (KG)	NUMBER OF STRANDS			
				2 STRAND	3 STRAND	4 STRAND	5 STRAND
				9195-	9195-	9195-	9195-
5VP560 15JP1420	1420	56	0.37	14202	14203	14204	14205
5VP600 15JP1525	1525	60	0.40	15252	15253	15254	15255
5VP630 15JP1600	1600	63	0.43	16002	16003	16004	16005
5VP670 15JP1700	1700	67	0.45	17002	17003	17004	17005
5VP710 15JP1800	1800	71	0.48	18002	18003	18004	18005
5VP750 15JP1900	1900	75	0.51	19002	19003	19004	19005
5VP800 15JP2030	2030	80	0.54	20302	20303	20304	20305
5VP850 15JP2160	2160	85	0.57	21602	21603	21604	21605
5VP900 15JP2285	2285	90	0.60	22852	22853	22854	22855
5VP950 15JP2415	2415	95	0.63	24152	24153	24154	24155
5VP1000 15JP2540	2540	100	0.67	25402	25403	25404	25405
5VP1060 15JP2690	2690	106	0.71	26902	26903	26904	26905
5VP1120 15JP2845	2845	112	0.83	28452	28453	28454	28455
5VP1180 15JP3000	3000	118	0.89	30002	30003	30004	30005
5VP1250 15JP3175	3175	125	0.93	31752	31753	31754	31755
5VP1320 15JP3350	3350	132	0.99	33502	33503	33504	33505
5VP1400 15JP3550	3550	140	1.05	35502	35503	35504	35505
5VP1500 15JP3810	3810	150	1.11	38102	38103	38104	38105
5VP1600 15JP4065	4065	160	1.18	40652	40653	40654	40655
5VP1700 15JP4315	4315	170	1.26	43152	43153	43154	43155
5VP1800 15JP4570	4570	180	1.33	45702	45703	45704	45705
5VP1900 15JP4825	4825	190	1.41	48252	48253	48254	48255
5VP2000 15JP5080	5080	200	1.48	50802	50803	50804	50805
5VP2120 15JP5385	5385	212	1.57	53852	53853	53854	53855
5VP2240 15JP5690	5690	224	1.66	56902	56903	56904	56905
5VP2360 15JP6000	6000	236	1.78	60002	60003	60004	60005
5VP2500 15JP6350	6350	250	1.87	63502	63503	63504	63505
5VP2650 15JP6730	6730	265	1.99	67302	67303	67304	67305
5VP2800 15JP7100	7100	280	2.11	71002	71003	71004	71005
5VP3000 15JP7620	7620	300	2.23	76202	76203	76204	76205
5VP3150 15JP8000	8000	315	2.38	80002	80003	80004	80005
5VP3350 15JP8500	8500	335	2.53	85002	85003	85004	85005
5VP3550 15JP9000	9000	355	2.67	90002	90003	90004	90005

* THE ITEM IS MADE-TO-ORDER, NOT IN STOCK. PLEASE REFER TO GATES E-COMMERCE WEBSITE FOR UPDATED INFORMATION



NUMBER OF STRANDS							
6 STRAND	7 STRAND	8 STRAND	9 STRAND	10 STRAND	11 STRAND	12 STRAND	"13 TO 16 STRAND MAXIMUM (##=STRANDS)"
9195-	9195-	9195-	9195-	9195-	9195-	9195-	9195-
14206	14207	14208	14209	14210	14211	14212	142##
15256	15257	15258	15259	15210	15211	15212	152##
16006	16007	16008	16009	16010	16011	16012	160##
17006	17007	17008	17009	17010	17011	17012	170##
18006	18007	18008	18009	18010	18011	18012	180##
19006	19007	19008	19009	19010	19011	19012	190##
20306	20307	20308	20309	20310	20311	20312	203##
21606	21607	21608	21609	21610	21611	21612	216##
22856	22857	22858	22859	22810	22811	22812	228##
24156	24157	24158	24159	24110	24111	24112	241##
25406	25407	25408	25409	25410	25411	25412	254##
26906	26907	26908	26909	26910	26911	26912	269##
28456	28457	28458	28459	28410	28411	28412	284##
30006	30007	30008	30009	30010	30011	30012	300##
31756	31757	31758	31759	31710	31711	31712	317##
33506	33507	33508	33509	33510	33511	33512	335##
35506	35507	35508	35509	35510	35511	35512	355##
38106	38107	38108	38109	38110	38111	38112	381##
40656	40657	40658	40659	40610	40611	40612	406##
43156	43157	43158	43159	43110	43111	43112	431##
45706	45707	45708	45709	45710	45711	45712	457##
48256	48257	48258	48259	48210	48211	48212	482##
50806	50807	50808	50809	50810	50811	50812	508##
53856	53857	53858	53859	53810	53811	53812	538##
56906	56907	56908	56909	56910	56911	56912	569##
60006	60007	60008	60009	60010	60011	60012	600##
63506	63507	63508	63509	63510	63511	63512	635##
67306	67307	67308	67309	67310	67311	67312	673##
71006	71007	71008	71009	71010	71011	71012	710##
76206	76207	76208	76209	76210	76211	76212	762##
80006	80007	80008	80009	80010	80011	80012	800##
85006	85007	85008	85009	85010	85011	85012	850##
90006	90007	90008	90009	90010	90011	90012	900##

* THE ITEM IS MADE-TO-ORDER, NOT IN STOCK. PLEASE REFER TO GATES E-COMMERCE WEBSITE FOR UPDATED INFORMATION



35 PREDATOR PB SPBP

DESCRIPTION	DATUM LENGTH (MM)	WEIGHT/STRAND (KG)	NUMBER OF STRANDS			
			2 STRAND	3 STRAND	4 STRAND	5 STRAND
			9193-	9193-	9193-	9193-
SPBP2120	2120	0.68	92102	92103	92104	92105
SPBP2240	2240	0.72	92202	92203	92204	92205
SPBP2360	2360	0.76	92302	92303	92304	92305
SPBP2400	2400	0.78	92402	92403	92404	92405
SPBP2500	2500	0.81	92502	92503	92504	92505
SPBP2650	2650	0.85	92602	92603	92604	92605
SPBP2800	2800	0.90	92802	92803	92804	92805
SPBP2900	2900	0.90	92902	92903	92904	92905
SPBP3000	3000	0.97	93002	93003	93004	93005
SPBP3150	3150	1.02	93102	93103	93104	93105
SPBP3250	3250	1.03	93202	93203	93204	93205
SPBP3350	3350	1.08	93302	93303	93304	93305
SPBP3550	3550	1.14	93502	93503	93504	93505
SPBP3650	3650	1.16	93602	93603	93604	93605
SPBP3750	3750	1.21	93702	93703	93704	93705
SPBP3800	3800	1.26	93802	93803	93804	93805
SPBP4000	4000	1.29	94002	94003	94004	94005
SPBP4250	4250	1.38	94202	94203	94204	94205
SPBP4500	4500	1.46	94502	94503	94504	94505
SPBP4750	4750	1.50	94702	94703	94704	94705
SPBP5000	5000	1.62	95002	95003	95004	95005
SPBP5300	5300	1.72	95302	95303	95304	95305
SPBP5600	5600	1.81	95602	95603	95604	95605
SPBP6000	6000	1.94	96002	96003	96004	96005
SPBP6300	6300	2.04	96302	96303	96304	96305
SPBP6700	6700	2.17	96702	96703	96704	96705
SPBP7100	7100	2.30	97102	97103	97104	97105
SPBP7500	7500	2.43	97502	97503	97504	97505
SPBP8000	8000	2.59	98002	98003	98004	98005

* THE ITEM IS MADE-TO-ORDER, NOT IN STOCK. PLEASE REFER TO GATES E-COMMERCE WEBSITE FOR UPDATED INFORMATION



NUMBER OF STRANDS							
6 STRAND	7 STRAND	8 STRAND	9 STRAND	10 STRAND	11 STRAND	12 STRAND	"13 TO 16 STRAND MAXIMUM (##=STRANDS)"
9193-	9193-	9193-	9193-	9193-	9193-	9193-	9193-
92106	92107	92108	92109	92110	92111	92112	921##
92206	92207	92208	92209	92210	92211	92212	922##
92306	92307	92308	92309	92310	92311	92312	923##
92406	92407	92408	92409	92410	92411	92412	924##
92506	92507	92508	92509	92510	92511	92512	925##
92606	92607	92608	92609	92610	92611	92612	926##
92806	92807	92808	92809	92810	92811	92812	928##
92906	92907	92908	92909	92910	92911	92912	929##
93006	93007	93008	93009	93010	93011	93012	930##
93106	93107	93108	93109	93110	93111	93112	931##
93206	93207	93208	93209	93210	93211	93212	932##
93306	93307	93308	93309	93310	93311	93312	933##
93506	93507	93508	93509	93510	93511	93512	935##
93606	93607	93608	93609	93610	93611	93612	936##
93706	93707	93708	93709	93710	93711	93712	937##
93806	93807	93808	93809	93810	93811	93812	938##
94006	94007	94008	94009	94010	94011	94012	940##
94206	94207	94208	94209	94210	94211	94212	942##
94506	94507	94508	94509	94510	94511	94512	945##
94706	94707	94708	94709	94710	94711	94712	947##
95006	95007	95008	95009	95010	95011	95012	950##
95306	95307	95308	95309	95310	95311	95312	953##
95606	95607	95608	95609	95610	95611	95612	956##
96006	96007	96008	96009	96010	96011	96012	960##
96306	96307	96308	96309	96310	96311	96312	963##
96706	96707	96708	96709	96710	96711	96712	967##
97106	97107	97108	97109	97110	97111	97112	971##
97506	97507	97508	97509	97510	97511	97512	975##
98006	98007	98008	98009	98010	98011	98012	980##

* THE ITEM IS MADE-TO-ORDER, NOT IN STOCK. PLEASE REFER TO GATES E-COMMERCE WEBSITE FOR UPDATED INFORMATION



36 PREDATOR PB SPCP

DESCRIPTION	DATUM LENGTH (MM)	WEIGHT/STRAND (KG)	NUMBER OF STRANDS		
			2 STRAND	3 STRAND	4 STRAND
			9194-	9194-	9194-
SPCP3000	3000	1.39	53002	53003	53004
SPCP3150	3150	1.46	53102	53103	53104
SPCP3350	3350	1.56	53302	53303	53304
SPCP3550	3550	1.65	53502	53503	53504
SPCP3750	3750	1.74	53702	53703	53704
SPCP4000	4000	1.86	54002	54003	54004
SPCP4250	4250	1.98	54202	54203	54204
SPCP4500	4500	2.09	54502	54503	54504
SPCP4750	4750	2.23	54702	54703	54704
SPCP5000	5000	2.35	55002	55003	55004
SPCP5300	5300	2.49	55302	55303	55304
SPCP5600	5600	2.63	55602	55603	55604
SPCP6000	6000	2.82	56002	56003	56004
SPCP6300	6300	2.92	56302	56303	56304
SPCP6700	6700	3.14	56702	56703	56704
SPCP7100	7100	3.33	57102	57103	57104
SPCP7500	7500	3.52	57502	57503	57504
SPCP8000	8000	3.76	58002	58003	58004
SPCP8500	8500	3.99	58502	58503	58504
SPCP9000	9000	4.23	59002	59003	59004
SPCP9500	9500	4.61	59502	59503	59504
SPCP10000	10000	4.70	51002	51003	51004
SPCP10600	10600	4.98	51062	51063	51064
SPCP11200	11200	5.26	51122	51123	51124

* THE ITEM IS MADE-TO-ORDER, NOT IN STOCK. PLEASE REFER TO GATES E-COMMERCE WEBSITE FOR UPDATED INFORMATION



NUMBER OF STRANDS							
5 STRAND	6 STRAND	7 STRAND	8 STRAND	9 STRAND	10 STRAND	11 STRAND	12 STRAND
9194-	9194-	9194-	9194-	9194-	9194-	9194-	9194-
53005	53006	53007	53008	53009	53010	53011	53012
53105	53106	53107	53108	53109	53110	53111	53112
53305	53306	53307	53308	53309	53310	53311	53312
53505	53506	53507	53508	53509	53510	53511	53512
53705	53706	53707	53708	53709	53710	53711	53712
54005	54006	54007	54008	54009	54010	54011	54012
54205	54206	54207	54208	54209	54210	54211	54212
54505	54506	54507	54508	54509	54510	54511	54512
54705	54706	54707	54708	54709	54710	54711	54712
55005	55006	55007	55008	55009	55010	55011	55012
55305	55306	55307	55308	55309	55310	55311	55312
55605	55606	55607	55608	55609	55610	55611	55612
56005	56006	56007	56008	56009	56010	56011	56012
56305	56306	56307	56308	56309	56310	56311	56312
56705	56706	56707	56708	56709	56710	56711	56712
57105	57106	57107	57108	57109	57110	57111	57112
57505	57506	57507	57508	57509	57510	57511	57512
58005	58006	58007	58008	58009	58010	58011	58012
58505	58506	58507	58508	58509	58510	58511	58512
59005	59006	59007	59008	59009	59010	59011	59012
59505	59506	59507	59508	59509	59510	59511	59512
51005	51006	51007	51008	51009	51010	51011	51012
51065	51066	51067	51068	51069	51070	51071	51072
51125	51126	51127	51128	51129	51130	51131	51132

* THE ITEM IS MADE-TO-ORDER, NOT IN STOCK. PLEASE REFER TO GATES E-COMMERCE WEBSITE FOR UPDATED INFORMATION



37 PREDATOR PB 8VP

DESCRIPTION (# = STRANDS)	EFFECTIVE LENGTH		WEIGHT/STRAND (KG)	NUMBER OF STRANDS		
	MM	INCH		2 STRAND	3 STRAND	4 STRAND
				9182-	9182-	9182-
8VP2000/#	5080	200	3.63	02212	03200	04200
8VP2120	5385	212	3.85		03212	04212
8VP2240	5690	224	4.08	02236	03224	04224
8VP2360	5994	236	4.28	02250	03236	04236
8VP2500	6350	250	4.56		03250	04250
8VP2650	6731	265	4.82	02280	03265	04265
8VP2800	7112	280	5.15	02300	03280	04280
8VP3000	7620	300	5.48		03315	04300
8VP3150	8001	315	5.71	02315		04315
8VP3350	8509	335	6.16	02335	03335	04335
8VP3550	9017	355	6.43	02355	03355	04355
8VP3750	9525	375	6.87	02375	03375	04375
8VP4000	10160	400	7.25	02400	03400	04400
8VP4250	10795	425	7.73	02425	03425	04425

* THE ITEM IS MADE-TO-ORDER, NOT IN STOCK. PLEASE REFER TO GATES E-COMMERCE WEBSITE FOR UPDATED INFORMATION



NUMBER OF STRANDS							
5 STRAND	6 STRAND	7 STRAND	8 STRAND	9 STRAND	10 STRAND	11 STRAND	12 STRAND
9182-	9182-	9182-	9182-	9182-	9182-	9182-	9182-
05200	06200	07212	08200	09200	10200	11200	12200
05212	06212		08224	09212	10212	11212	12212
05224	06224	07224		09224	10224	11224	12224
05236	06236	07236	08250	09236	10236	11236	12236
05250	06250	07250		09265	10250	11250	12250
05265	06265	07265	08265		10265	11265	12265
05280	06280	07300	08280	09280	10280	11280	12280
05300	06300		08300	09300	10300	11300	12300
05315	06315	07315	08315	09315	10315	11315	12315
05335	06335	07335	08335	09335	10335	11335	12335
05355	06355	07355	08375	09355	10355	11355	12355
05375	06375	07375		09375	10375	11375	12375
05400	06400	07400	08400	09400	10400	11400	12400
05425	06425	07425	08425	09425	10425	11425	12425

* THE ITEM IS MADE-TO-ORDER, NOT IN STOCK. PLEASE REFER TO GATES E-COMMERCE WEBSITE FOR UPDATED INFORMATION



38 QUAD-POWER 4 POWERBAND - XPZ

QUAD POWER 4
POWERBAND

DESCRIPTION (# = STRANDS)	DATUM LENGTH (MM)	WEIGHT/STRAND (KG)	NUMBER OF STRANDS		
			2 STRAND	3 STRAND	4 STRAND
XPZ800/#	800	0.07	9683-08002*	9683-08003*	9683-08004*
XPZ850	850	0.07	9683-08502*	9683-08503*	9683-08504*
XPZ900	900	0.08	9683-09002*	9683-09003*	9683-09004*
XPZ950	950	0.08	9683-09502*	9683-09503*	9683-09504*
XPZ1000	1000	0.09	9683-10002*	9683-10003*	9683-10004*
XPZ1030	1030	0.08	9683-10202*	9683-10303*	9683-10304*
XPZ1060	1060	0.09	9683-10602*	9683-10603*	9683-10604*
XPZ1090	1090	0.09	9683-10902*	9683-10903*	9683-10904*
XPZ1120	1120	0.10	9683-11202*	9683-11203*	9683-11204*
XPZ1150	1150	0.10	9683-11502*	9683-11503*	9683-11504*
XPZ1180	1180	0.10	9683-11802*	9683-11803*	9683-11804*
XPZ1212	1212	0.10	9683-12122*	9683-12123*	9683-12124*
XPZ1250	1250	0.11	9683-12502*	9683-12503*	9683-12504*
XPZ1270	1270	0.10	9683-12702*	9683-12703*	9683-12704*
XPZ1320	1320	0.11	9683-13202*	9683-13203*	9683-13204*
XPZ1340	1340	0.12	9683-13402*	9683-13403*	9683-13404*
XPZ1362	1362	0.12	9683-13622*	9683-13623*	9683-13624*
XPZ1400	1400	0.12	9683-14002*	9683-14003*	9683-14004*
XPZ1420	1420	0.12	9683-14202*	9683-14203*	9683-14204*
XPZ1450	1450	0.12	9683-14502*	9683-14503*	9683-14504*
XPZ1487	1487	0.13	9683-14872*	9683-14873*	9683-14874*
XPZ1500	1500	0.12	9683-15002*	9683-15003*	9683-15004*
XPZ1550	1550	0.13	9683-15502*	9683-15503*	9683-15504*
XPZ1600	1600	0.14	9683-16002*	9683-16003*	9683-16004*
XPZ1650	1650	0.14	9683-16502*	9683-16503*	9683-16504*
XPZ1700	1700	0.15	9683-17002*	9683-17003*	9683-17004*
XPZ1750	1750	0.15	9683-17502*	9683-17503*	9683-17504*
XPZ1800	1800	0.16	9683-18002*	9683-18003*	9683-18004*
XPZ1850	1850	0.14	9683-18502*	9683-18503*	9683-18504*
XPZ1900	1900	0.15	9683-19002*	9683-19003*	9683-19004*
XPZ1950	1950	0.15	9683-19502*	9683-19503*	9683-19504*
XPZ2000	2000	0.15	9683-20002*	9683-20003*	9683-20004*
XPZ2030	2030	0.16	9683-20202*	9683-20303*	9683-20304*
XPZ2120	2120	0.16	9683-21202*	9683-21203*	9683-21204*
XPZ2160	2160	0.17	9683-21602*	9683-21603*	9683-21604*
XPZ2240	2240	0.17	9683-22402*	9683-22403*	9683-22404*
XPZ2360	2360	0.18	9683-23602*	9683-23603*	9683-23604*
XPZ2500	2500	0.19	9683-25002*	9683-25003*	9683-25004*
XPZ2650	2650	0.21	9683-26502*	9683-26503*	9683-26504*
XPZ2800	2800	0.22	9683-28002*	9683-28003*	9683-28004*
XPZ3000	3000	0.23	9683-30002*	9683-30003*	9683-30004*
XPZ3150	3150	0.24	9683-31502*	9683-31503*	9683-31504*
XPZ3350	3350	0.22	9683-33502*	9683-33503*	9683-33504*
XPZ3550	3550	0.24	9683-35502*	9683-35503*	9683-35504*

* THE ITEM IS MADE-TO-ORDER, NOT IN STOCK. PLEASE REFER TO GATES E-COMMERCE WEBSITE FOR UPDATED INFORMATION



39 QUAD-POWER 4 POWERBAND - XPA

QUAD POWER 4
POWERBAND

DESCRIPTION (# = STRANDS)	DATUM LENGTH (MM)	WEIGHT/STRAND (KG)	NUMBER OF STRANDS	
			2 STRAND	3 STRAND
XPA800 /#	800	0.11	9684-08002*	9684-08003*
XPA850	850	0.12	9684-08502*	9684-08503*
XPA900	900	0.13	9684-09002*	9684-09003*
XPA950	950	0.13	9684-09502*	9684-09503*
XPA1000	1000	0.14	9684-10002*	9684-10003*
XPA1030	1030	0.14	9684-10302*	9684-10303*
XPA1060	1060	0.15	9684-10602*	9684-10603*
XPA1090	1090	0.15	9684-10902*	9684-10903*
XPA1120	1120	0.16	9684-11202*	9684-11203*
XPA1150	1150	0.16	9684-11502*	9684-11503*
XPA1180	1180	0.17	9684-11802*	9684-11803*
XPA1250	1250	0.17	9684-12502*	9684-12503*
XPA1320	1320	0.18	9684-13202*	9684-13203*
XPA1360	1360	0.19	9684-13602*	9684-13603*
XPA1400	1400	0.20	9684-14002*	9684-14003*
XPA1450	1450	0.20	9684-14502*	9684-14503*
XPA1500	1500	0.21	9684-15002*	9684-15003*
XPA1550	1550	0.22	9684-15502*	9684-15503*
XPA1600	1600	0.22	9684-16002*	9684-16003*
XPA1650	1650	0.23	9684-16502*	9684-16503*
XPA1700	1700	0.24	9684-17002*	9684-17003*
XPA1750	1750	0.25	9684-17502*	9684-17503*
XPA1800	1800	0.25	9684-18002*	9684-18003*
XPA1850	1850	0.23	9684-18502*	9684-18503*
XPA1900	1900	0.24	9684-19002*	9684-19003*
XPA1950	1950	0.24	9684-19502*	9684-19503*
XPA2000	2000	0.25	9684-20002*	9684-20003*
XPA2060	2060	0.26	9684-20602*	9684-20603*
XPA2120	2120	0.26	9684-21202*	9684-21203*
XPA2240	2240	0.28	9684-22402*	9684-22403*
XPA2360	2360	0.29	9684-23602*	9684-23603*
XPA2430	2430	0.30	9684-24302*	9684-24303*
XPA2500	2500	0.31	9684-25002*	9684-25003*
XPA2650	2650	0.33	9684-26502*	9684-26503*
XPA2800	2800	0.35	9684-28002*	9684-28003*
XPA3000	3000	0.37	9684-30002*	9684-30003*
XPA3150	3150	0.39	9684-31502*	9684-31503*
XPA3350	3350	0.36	9684-33502*	9684-33503*
XPA3550	3550	0.38	9684-35502*	9684-35503*
XPA3750	3750	0.40	9684-37502*	9684-37503*
XPA4000	4000	0.43	9684-40002*	9684-40003*

* THE ITEM IS MADE-TO-ORDER, NOT IN STOCK. PLEASE REFER TO GATES E-COMMERCE WEBSITE FOR UPDATED INFORMATION



40 QUAD-POWER 4 POWERBAND - XPB

DESCRIPTION (# = STRANDS)	DATUM LENGTH (MM)	WEIGHT/STRAND (KG)	NUMBER OF STRANDS	
			2 STRAND	3 STRAND
XPB1250 /#	1250	0.29	9685-12502*	9685-12503*
XPB1320	1320	0.30	9685-13202*	9685-13203*
XPB1400	1400	0.32	9685-14002*	9685-14003*
XPB1450	1450	0.33	9685-14502*	9685-14503*
XPB1500	1500	0.35	9685-15002*	9685-15003*
XPB1550	1550	0.36	9685-15502*	9685-15503*
XPB1600	1600	0.37	9685-16002*	9685-16003*
XPB1650	1650	0.38	9685-16502*	9685-16503*
XPB1700	1700	0.39	9685-17002*	9685-17003*
XPB1750	1750	0.40	9685-17502*	9685-17503*
XPB1800	1800	0.42	9685-18002*	9685-18003*
XPB1850	1850	0.38	9685-18502*	9685-18503*
XPB1900	1900	0.39	9685-19002*	9685-19003*
XPB1950	1950	0.40	9685-19502*	9685-19503*
XPB2000	2000	0.41	9685-20002*	9685-20003*
XPB2120	2120	0.43	9685-21202*	9685-21203*
XPB2150	2150	0.44	9685-21502*	9685-21503*
XPB2240	2240	0.46	9685-22402*	9685-22403*
XPB2280	2280	0.47	9685-22802*	9685-22803*
XPB2360	2360	0.48	9685-23602*	9685-23603*
XPB2410	2410	0.50	9685-24102*	9685-24103*
XPB2500	2500	0.51	9685-25002*	9685-25003*
XPB2530	2530	0.52	9685-25302*	9685-25303*
XPB2650	2650	0.54	9685-26502*	9685-26503*
XPB2680	2680	0.55	9685-26802*	9685-26803*
XPB2800	2800	0.57	9685-28002*	9685-28003*
XPB2840	2840	0.58	9685-28402*	9685-28403*
XPB3000	3000	0.61	9685-30002*	9685-30003*
XPB3150	3150	0.65	9685-31502*	9685-31503*
XPB3350	3350	0.59	9685-33502*	9685-33503*
XPB3550	3550	0.63	9685-35502*	9685-35503*
XPB3750	3750	0.66	9685-37502*	9685-37503*
XPB4000	4000	0.71	9685-40002*	9685-40003*
XPB4250	4250	0.75	9685-42502*	9685-42503*
XPB4500	4500	0.79	9685-45002*	9685-45003*
XPB4750	4750	0.84	9685-47502*	9685-47503*

* THE ITEM IS MADE-TO-ORDER, NOT IN STOCK. PLEASE REFER TO GATES E-COMMERCE WEBSITE FOR UPDATED INFORMATION



41 SUPER HC MN POWERBAND



For technical data, [CLICK HERE](#) or use the QR-code.

SUPER HC MN
POWERBAND



42 SUPER HC POWERBAND - SPB

DESCRIPTION (# = STRANDS)	DATUM LENGTH (MM)	WEIGHT/STRAND (KG)	NUMBER OF STRANDS			
			2 STRAND	3 STRAND	4 STRAND	5 STRAND
			9381-	9381-	9381-	9381-
SPB2120 /#	2120	0.65	92102	92103	92104	92105
SPB2240	2240	0.69	92202	92203	92204	92205
SPB2360	2360	0.73	92302	92303	92304	92305
SPB2500	2500	0.77	92502	92503	92504	92505
SPB2650	2650	0.81	92602	92603	92604	92605
SPB2800	2800	0.86	92802	92803	92804	92805
SPB3000	3000	0.92	93002	93003	93004	93005
SPB3150	3150	0.97	93102	93103	93104	93105
SPB3350	3350	1.04	93302	93303	93304	93305
SPB3550	3550	1.09	93502	93503	93504	93505
SPB3750	3750	1.16	93702	93703	93704	93705
SPB4000	4000	1.23	94002	94003	94004	94005
SPB4250	4250	1.31	94202	94203	94204	94205
SPB4500	4500	1.39	94502	94503	94504	94505
SPB4750	4750	1.46	94702	94703	94704	94705
SPB5000	5000	1.54	95002	95003	95004	95005
SPB5300	5300	1.64	95302	95303	95304	95305
SPB5600	5600	1.73	95602	95603	95604	95605
SPB6000	6000	1.85	96002	96003	96004	96005
SPB6300	6300	1.94	96302	96303	96304	96305
SPB6700	6700	2.07	96702	96703	96704	96705
SPB7100	7100	2.19	97102	97103	97104	97105
SPB7500	7500	2.32	97502	97503	97504	97505
SPB8000	8000	2.47	98002	98003	98004	98005

SUPER HC POWERBAND

* THE ITEM IS MADE-TO-ORDER, NOT IN STOCK. PLEASE REFER TO GATES E-COMMERCE WEBSITE FOR UPDATED INFORMATION



NUMBER OF STRANDS							
6 STRAND	7 STRAND	8 STRAND	9 STRAND	10 STRAND	11 STRAND	12 STRAND	"13 TO 16 STRAND MAXIMUM (##=STRANDS)"
9381-	9381-	9381-	9381-	9381-	9381-	9381-	9381-
92106	92107	92108	92109	92110	92111	92112	921##
92206	92207	92208	92209	92210	92211	92212	922##
92306	92307	92308	92309	92310	92311	92312	923##
92506	92507	92508	92509	92510	92511	92512	925##
92606	92607	92608	92609	92610	92611	92612	926##
92806	92807	92808	92809	92810	92811	92812	928##
93006	93007	93008	93009	93010	93011	93012	930##
93106	93107	93108	93109	93110	93111	93112	931##
93306	93307	93308	93309	93310	93311	93312	933##
93506	93507	93508	93509	93510	93511	93512	935##
93706	93707	93708	93709	93710	93711	93712	937##
94006	94007	94008	94009	94010	94011	94012	940##
94206	94207	94208	94209	94210	94211	94212	942##
94506	94507	94508	94509	94510	94511	94512	945##
94706	94707	94708	94709	94710	94711	94712	947##
95006	95007	95008	95009	95010	95011	95012	950##
95306	95307	95308	95309	95310	95311	95312	953##
95606	95607	95608	95609	95610	95611	95612	956##
96006	96007	96008	96009	96010	96011	96012	960##
96306	96307	96308	96309	96310	96311	96312	963##
96706	96707	96708	96709	96710	96711	96712	967##
97106	97107	97108	97109	97110	97111	97112	971##
97506	97507	97508	97509	97510	97511	97512	975##
98006	98007	98008	98009	98010	98011	98012	980##

SUPER HC
POWERBAND

* THE ITEM IS MADE-TO-ORDER, NOT IN STOCK. PLEASE REFER TO GATES E-COMMERCE WEBSITE FOR UPDATED INFORMATION



43 SUPER HC POWERBAND - SPC

DESCRIPTION (# = STRANDS)	DATUM LENGT (MM)	WEIGHT/STRAND (KG)	NUMBER OF STRANDS		
			2 STRAND	3 STRAND	4 STRAND
			9381-	9381-	9381-
SPC3000 /#	3000	1.33	53002	53003	53004
SPC3150	3150	1.39	53102	53103	53104
SPC3350	3350	1.48	53302	53303	53304
SPC3550	3550	1.57	53502	53503	53504
SPC3750	3750	1.66	53702	53703	53704
SPC4000	4000	1.77	54002	54003	54004
SPC4250	4250	1.88	54202	54203	54204
SPC4500	4500	1.99	54502	54503	54504
SPC4750	4750	2.12	54702	54703	54704
SPC5000	5000	2.23	55002	55003	55004
SPC5300	5300	2.37	55302	55303	55304
SPC5600	5600	2.50	55602	55603	55604
SPC6000	6000	2.68	56002	56003	56004
SPC6300	6300	2.82	56302	56303	56304
SPC6700	6700	3.00	56702	56703	56704
SPC7100	7100	3.17	57102	57103	57104
SPC7500	7500	3.35	57502	57503	57504
SPC8000	8000	3.58	58002	58003	58004
SPC8500	8500	3.80	58502	58503	58504
SPC9000	9000	4.03	59002	59003	59004
SPC9500	9500	4.25	59502	59503	59504
SPC10000	10000	4.47	51002	51003	51004
SPC10600	10600	4.74	51062	51063	51064
SPC11200	11200	5.01	51122	51123	51124

SUPER HC
POWERBAND

* THE ITEM IS MADE-TO-ORDER, NOT IN STOCK. PLEASE REFER TO GATES E-COMMERCE WEBSITE FOR UPDATED INFORMATION



NUMBER OF STRANDS							
5 STRAND	6 STRAND	7 STRAND	8 STRAND	9 STRAND	10 STRAND	11 STRAND	12 STRAND
9381-	9381-	9381-	9381-	9381-	9381-	9381-	9381-
53005	53006	53007	53008	53009	53010	53011	53012
53105	53106	53107	53108	53109	53110	53111	
53305	53306	53307	53308	53309	53310	53311	53312
53505	53506	53507	53508	53509	53510	53511	
53705	53706	53707	53708	53709	53710	53711	53712
54005	54006	54007	54008	54009	54010	54011	
54205	54206	54207	54208	54209	54210	54211	54212
54505	54506	54507	54508	54509	54510	54511	54512
54705	54706	54707	54708	54709	54710	54711	54712
55005	55006	55007	55008	55009	55010	55011	55012
55305	55306	55307	55308	55309	55310	55311	55312
55605	55606	55607	55608	55609	55610	55611	55612
56005	56006	56007	56008	56009	56010	56011	56012
56305	56306	56307	56308	56309	56310	56311	56312
56705	56706	56707	56708	56709	56710	56711	56712
57105	57106	57107	57108	57109	57110	57111	57112
57505	57506	57507	57508	57509	57510	57511	57512
58005	58006	58007	58008	58009	58010	58011	58012
58505	58506	58507	58508	58509	58510	58511	58512
59005	59006	59007	59008	59009	59010	59011	59012
59505	59506	59507	59508	59509	59510	59511	59512
51005	51006	51007	51008	51009	51010	51011	51012
51065	51066	51067	51068	51069	51070	51071	51072
51125	51126	51127	51128	51129	51130	51131	51132

SUPER HC
POWERBAND

* THE ITEM IS MADE-TO-ORDER, NOT IN STOCK. PLEASE REFER TO GATES E-COMMERCE WEBSITE FOR UPDATED INFORMATION



44 SUPER HC POWERBAND - 3V-9J

DESCRIPTION (# = STRANDS)	EFFECTIVE LENGTH		WEIGHT/STRAND (KG)	NUMBER OF STRANDS			
	(MM)	(INCH)		2 STRAND	3 STRAND	4 STRAND	5 STRAND
				9385-	9385-	9385-	9385-
3V300 9J762	762	30.0	0.08	02030*	03030*	04030*	05030*
3V315 9J800	800	31.5	0.08	02031*	03031*	04031*	05031*
3V335 9J850	850	33.5	0.09				05033*
3V355 9J901	901	35.5	0.10	02035*	03035*	04035*	
3V375 9J952	952	37.5	0.10	02037*	03037*	04037*	05037*
3V400 9J1016	1016	40.0	0.11	02040*	03040*	04040*	
3V425 9J1079	1079	42.5	0.12	02042*	03042*	04042*	
3V450 9J1143	1143	45.0	0.13	02045*	03045*	04045*	
3V475 9J1206	1206	47.5	0.13	02047*	03047*	04047*	05047*
3V500 9J1270	1270	50.0	0.14	02050*	03050*	04050*	
3V530 9J1346	1346	53.0	0.15		03053*	04053*	05053*
3V560 9J1420	1420	56.0	0.16	14202	14203	14204	14205
3V600 9J1525	1525	60.0	0.17	15252	15253	15254	15255
3V630 9J1600	1600	63.0	0.18	16002	16003	16004	16005
3V670 9J1700	1700	67.0	0.19	17002	17003	17004	17005
3V710 9J1800	1800	71.0	0.20	18002	18003	18004	18005
3V750 9J1900	1900	75.0	0.21	19002	19003	19004	19005
3V800 9J2030	2030	80.0	0.23	20302	20303	20304	20305
3V850 9J2160	2160	85.0	0.24	21602	21603	21604	21605
3V900 9J2285	2285	90.0	0.25	22852	22853	22854	22855
3V950 9J2415	2415	95.0	0.27	24152	24153	24154	24155
3V1000 9J2540	2540	100.0	0.28	25402	25403	25404	25405
3V1060 9J2690	2690	106.0	0.30	26902	26903	26904	26905
3V1120 9J2845	2845	112.0	0.32	28452	28453	28454	28455
3V1180 9J3000	3000	118.0	0.34	30002	30003	30004	30005
3V1250 9J3175	3175	125.0	0.36	31752	31753	31754	31755
3V1320 9J3350	3350	132.0	0.38	33502	33503	33504	33505
3V1400 9J3550	3550	140.0	0.40	35502	35503	35504	35505

SUPER HC POWERBAND

* THE ITEM IS MADE-TO-ORDER, NOT IN STOCK. PLEASE REFER TO GATES E-COMMERCE WEBSITE FOR UPDATED INFORMATION



NUMBER OF STRANDS							
6 STRAND	7 STRAND	8 STRAND	9 STRAND	10 STRAND	11 STRAND	12 STRAND	### TO 16 STRAND MAXIMUM (##=STRANDS)"
9385-	9385-	9385-	9385-	9385-	9385-	9385-	9385-
06030*	07030*	08030*	09030*	10030*	11030*		##030*
06031*	07031*	08031*	09031*	10031*	11031*		##031*
06033*	07033*	08033*	09033*	10033*	11033*	12033*	##033*
	07035*	08035*	09035*	10035*	11035*		##035*
06037*	07037*	08037*	09037*	10037*	11037*	12037*	##037*
	07040*	08040*	09040*	10040*	11040*		##040*
	07042*	08042*	09042*	10042*	11042*		##042*
06045*	07045*		09045*	10045*	11045*		##045*
06047*	07047*	08047*	09047*		11047*		##047*
06050*		08050*	09050*	10050*	11050*	12050*	##050*
	07053*	08053*	09053*	10053*	11053*		##053*
14206	14207	14208	14209	14210	14211	14212	142##
15256	15257	15258	15259	15210	15211	15212	152##
16006	16007	16008	16009	16010	16011	16012	160##
17006	17007	17008	17009	17010	17011	17012	170##
18006	18007	18008	18009	18010	18011	18012	180##
19006	19007	19008	19009	19010	19011	19012	190##
20306	20307	20308	20309	20310	20311	20312	203##
21606	21607	21608	21609	21610	21611	21612	216##
22856	22857	22858	22859	22810	22811	22812	228##
24156	24157	24158	24159	24110	24111	24112	241##
25406	25407	25408	25409	25410	25411	25412	254##
26906	26907	26908	26909	26910	26911	26912	269##
28456	28457	28458	28459	28410	28411	28412	284##
30006	30007	30008	30009	30010	30011	30012	300##
31756	31757	31758	31759	31710	31711	31712	317##
33506	33507	33508	33509	33510	33511	33512	335##
35506	35507	35508	35509	35510	35511	35512	355##

SUPER HC
POWERBAND

* THE ITEM IS MADE-TO-ORDER, NOT IN STOCK. PLEASE REFER TO GATES E-COMMERCE WEBSITE FOR UPDATED INFORMATION



45 SUPER HC POWERBAND 5V-15J

DESCRIPTION (# = STRANDS)	EFFECTIVE LENGTH		WEIGHT/STRAND (KG)	NUMBER OF STRANDS			
	(MM)	(INCH)		2 STRAND	3 STRAND	4 STRAND	5 STRAND
				9386-	9386-	9386-	9386-
5V560 15J1420 /#	1420	56	0.35	14202	14203	14204	14205
5V600 15J1525	1525	60	0.38	15252	15253	15254	15255
5V630 15J1600	1600	63	0.41	16002	16003	16004	16005
5V670 15J1700	1700	67	0.43	17002	17003	17004	17005
5V710 15J1800	1800	71	0.46	18002	18003	18004	18005
5V750 15J1900	1900	75	0.49	19002	19003	19004	19005
5V800 15J2030	2030	80	0.51	20302	20303	20304	20305
5V850 15J2160	2160	85	0.54	21602	21603	21604	21605
5V900 15J2285	2285	90	0.57	22852	22853	22854	22855
5V950 15J2415	2415	95	0.60	24152	24153	24154	24155
5V1000 15J2540	2540	100	0.64	25402	25403	25404	25405
5V1060 15J2690	2690	106	0.68	26902	26903	26904	26905
5V1120 15J2845	2845	112	0.79	28452	28453	28454	28455
5V1180 15J3000	3000	118	0.84	30002	30003	30004	30005
5V1210 15J3075	3075	121	0.84	30752	30753	30754	30755
5V1250 15J3175	3175	125	0.89	31752	31753	31754	31755
5V1320 15J3350	3350	132	0.94	33502	33503	33504	33505
5V1400 15J3550	3550	140	1.00	35502	35503	35504	35505
5V1500 15J3810	3810	150	1.05	38102	38103	38104	38105
5V1600 15J4065	4065	160	1.13	40652	40653	40654	40655
5V1700 15J4315	4315	170	1.20	43152	43153	43154	43155
5V1800 15J4570	4570	180	1.27	45702	45703	45704	45705
5V1900 15J4825	4825	190	1.34	48252	48253	48254	48255
5V2000 15J5080	5080	200	1.41	50802	50803	50804	50805
5V2120 15J5385	5385	212	1.50	53852	53853	53854	53855
5V2240 15J5690	5690	224	1.58	56902	56903	56904	56905
5V2360 15J6000	6000	236	1.70	60002	60003	60004	60005
5V2500 15J6350	6350	250	1.78	63502	63503	63504	63505
5V2650 15J6730	6730	265	1.90	67302	67303	67304	67305
5V2800 15J7100	7100	280	2.01	71002	71003	71004	71005
5V3000 15J7620	7620	300	2.13	76202	76203	76204	76205
5V3150 15J8000	8000	315	2.27	80002	80003	80004	80005
5V3350 15J8500	8500	335	2.41	85002	85003	85004	85005
5V3550 15J9000	9000	355	2.55	90002	90003	90004	90005

SUPER HC POWERBAND

* THE ITEM IS MADE-TO-ORDER, NOT IN STOCK. PLEASE REFER TO GATES E-COMMERCE WEBSITE FOR UPDATED INFORMATION



NUMBER OF STRANDS							
6 STRAND	7 STRAND	8 STRAND	9 STRAND	10 STRAND	11 STRAND	12 STRAND	### TO 16 STRAND MAXIMUM (##=STRANDS)"
9386-	9386-	9386-	9386-	9386-	9386-	9386-	9386-
14206	14207	14208	14209	14210	14211	14212	142##*
15256	15257	15258	15259	15210	15211	15212	152##*
16006	16007	16008	16009	16010	16011	16012	160##
17006	17007	17008	17009	17010	17011	17012	170##
18006	18007	18008	18009	18010	18011	18012	180##
19006	19007	19008	19009	19010	19011	19012	190##
20306	20307	20308	20309	20310	20311	20312	203##*
21606	21607	21608	21609	21610	21611	21612	216##*
22856	22857	22858	22859	22810	22811	22812	228##*
24156	24157	24158	24159	24110	24111	24112	241##*
25406	25407	25408	25409	25410	25411	25412	254##*
26906	26907	26908	26909	26910	26911	26912	269##*
28456	28457	28458	28459	28410	28411	28412	284##*
30006	30007	30008	30009	30010	30011	30012	300##*
30756	30757	30758	30759	30710	30711	30712	307##*
31756	31757	31758	31759	31710	31711	31712	317##*
33506	33507	33508	33509	33510	33511	33512	335##
35506	35507	35508	35509	35510	35511	35512	355##
38106	38107	38108	38109	38110	38111	38112	381##*
40656	40657	40658	40659	40610	40611	40612	406##*
43156	43157	43158	43159	43110	43111	43112	431##*
45706	45707	45708	45709	45710	45711	45712	457##
48256	48257	48258	48259	48210	48211	48212	482##*
50806	50807	50808	50809	50810	50811	50812	508##*
53856	53857	53858	53859	53810	53811	53812	538##
56906	56907	56908	56909	56910	56911	56912	569##*
60006	60007	60008	60009	60010	60011	60012	600##
63506	63507	63508	63509	63510	63511	63512	635##*
67306	67307	67308	67309	67310	67311	67312	673##*
71006	71007	71008	71009	71010	71011	71012	710##
76206	76207	76208	76209	76210	76211	76212	762##*
80006	80007	80008	80009	80010	80011	80012	800##
85006	85007	85008	85009	85010	85011	85012	850##
90006	90007	90008	90009	90010	90011	90012	900##*

SUPER HC
POWERBAND

* THE ITEM IS MADE-TO-ORDER, NOT IN STOCK. PLEASE REFER TO GATES E-COMMERCE WEBSITE FOR UPDATED INFORMATION



46 SUPER HC POWERBAND 8V

DESCRIPTION (# = STRANDS)	EFFECTIVE LENGTH		WEIGHT/STRAND (KG)	NUMBER OF STRANDS			
	(MM)	(INCH)		2 STRAND	3 STRAND	4 STRAND	5 STRAND
				9387-	9387-	9387-	9387-
8V1000	2540	100	1.77	02100	03100	04100	05100
8V1060	2690	106	1.88	02106	03106	04106	
8V1120	2845	112	2.00		03112	04112	05112
8V1180	3000	118	2.12		03118	04118	05118
8V1250	3175	125	2.27	02125	03125	04125	05125
8V1320	3350	132	2.38		03132	04132	05132
8V1400	3550	140	2.53	02140	03140	04140	05140
8V1500	3810	150	2.72	02150	03150	04150	05150
8V1600	4065	160	2.87	02160	03160	04160	05160
8V1700	4315	170	3.06	02170	03170	04170	05170
8V1800	4570	180	3.29	02180	03180	04180	05180
8V1900	4825	190	3.48	02190	03190	04190	05190
8V2000	5080	200	3.63	02200	03200	04200	05200
8V2120	5385	212	3.86	02212	03212	04212	05212
8V2240	5690	224	4.08	02224	03224	04224	05224
8V2360	6000	236	4.27		03236	04236	05236
8V2500	6350	250	4.54	02250	03250	04250	05250
8V2650	6730	265	4.80	02265	03265	04265	05265
8V2800	7100	280	5.14	02280	03280	04280	05280
8V3000	7620	300	5.48	02300	03300	04300	05300
8V3150	8000	315	5.78	02315	03315	04315	05315
8V3350	8500	335	6.16	02335	03335	04335	05335
8V3550	9000	355	6.50		03355	04355	05355
8V3750	9525	375	6.84	02375	03375	04375	05375
8V4000	10160	400	7.29		03400	04400	05400
8V4250	10795	425	7.75		03425	04425	05425
8V4500	11430	450	8.20	02450	03450	04450	05450
8V4750	12065	475	8.70	02475	03475	04475	05475
8V5000	12700	500	9.15		03500	04500	05500
8V5600	14224	560	10.32	02560	03560	04560	
8V6000	15240	600	11.08	02600	03600	04600	05600

SUPER HC POWERBAND

* THE ITEM IS MADE-TO-ORDER, NOT IN STOCK. PLEASE REFER TO GATES E-COMMERCE WEBSITE FOR UPDATED INFORMATION



NUMBER OF STRANDS						
6 STRAND	7 STRAND	8 STRAND	9 STRAND	10 STRAND	11 STRAND	12 STRAND
9387-	9387-	9387-	9387-	9387-	9387-	9387-
06100	07100	08100	09100	10100	11100	12100
06106	07106		09106	10106	11106	12106
	07112	08112	09112	10112	11112	12112
06118	07118		09118	10118	11118	12118
06125	07125	08125	09125	10125	11125	12125
	07132		09132	10132	11132	12132
06140	07140	08140	09140	10140	11140	12140
06150	07150	08150	09150	10150	11150	12150
06160	07160	08160	09160	10160	11160	12160
06170	07170		09170	10170	11170	12170
06180	07180	08180	09180	10180	11180	12180
06190	07190	08190	09190	10190	11190	12190
06200	07200	08200	09200	10200	11200	12200
06212	07212	08212	09212	10212	11212	12212
06224	07224	08224	09224	10224	11224	12224
06236	07236	08236	09236	10236	11236	12236
06250	07250	08250	09250	10250	11250	12250
06265	07265	08265		10265	11265	12265
06280	07280	08280	09280	10280	11280	12280
06300	07300	08300	09300	10300	11300	12300
06315	07315	08315	09315	10315	11315	12315
06335	07335	08335	09335	10335	11335	12335
	07355	08355	09355	10355	11355	12355
06375		08375	09375	10375	11375	12375
06400	07400	08400	09400	10400	11400	12400
06425	07425		09425	10425	11425	12425
06450	07450	08450	09450	10450	11450	12450
06475	07475	08475	09475	10475	11475	12475
06500	07500	08500	09500	10500	11500	12500
06560	07560	08560	09560	10560	11560	12560
06600	07600	08600	09600	10600	11600	12600

SUPER HC
POWERBAND

* THE ITEM IS MADE-TO-ORDER, NOT IN STOCK. PLEASE REFER TO GATES E-COMMERCE WEBSITE FOR UPDATED INFORMATION



47 HI-POWER POWERBAND



For technical data, [CLICK HERE](#) or use the QR-code.

48 HI-POWER DUBL-V



For technical data, [CLICK HERE](#) or use the QR-code.

49 MULTI-SPEED



For technical data, [CLICK HERE](#) or use the QR-code.



50 POWERATED



For technical data, [CLICK HERE](#) or use the QR-code.

51 POLYFLEX



For technical data, [CLICK HERE](#) or use the QR-code.

52 POLYFLEX JB



For technical data, [CLICK HERE](#) or use the QR-code.



53 MICRO-V - PJ

DESCRIPTION DIN 7867	RMA	EFFECTIVE LENGTH (MM)	WEIGHT(KG)
PJ356	140J	356	0.003
PJ381	150J	381	0.003
PJ406	160J	406	0.004
PJ432	170J	432	0.004
PJ457	180J	457	0.004
PJ483	190J	483	0.004
PJ508	200J	508	0.005
PJ559	220J	559	0.005
PJ584	230J	584	0.005
PJ610	240J	610	0.006
PJ660	260J	660	0.006
PJ711	280J	711	0.007
PJ723	285J	723	0.007
PJ737	290J	737	0.007
PJ762	300J	762	0.007
PJ813	320J	813	0.008
PJ838	330J	838	0.008
PJ864	340J	864	0.008
PJ914	360J	914	0.009
PJ955	376J	955	0.009
PJ965	380J	965	0.009
PJ1016	400J	1016	0.010
PJ1041	410J	1041	0.010
PJ1067	420J	1067	0.010
PJ1092	430J	1092	0.010
PJ1105	435J	1105	0.010
PJ1110	437J	1110	0.010
PJ1118	440J	1118	0.010
PJ1123	442J	1123	0.010
PJ1130	445J	1130	0.011
PJ1136	447J	1136	0.011
PJ1150	453J	1150	0.011
PJ1168	460J	1168	0.011
PJ1194	470J	1194	0.011
PJ1200	473J	1200	0.011
PJ1222	480J	1222	0.012
PJ1233	485J	1233	0.012
PJ1244	490J	1244	0.012
PJ1262	497J	1262	0.012
PJ1270	500J	1270	0.012
PJ1280	504J	1280	0.012
PJ1300	512J	1300	0.012
PJ1309	515J	1309	0.012
PJ1321	520J	1321	0.012
PJ1333	525J	1333	0.013
PJ1355	534J	1355	0.013
PJ1371	540J	1371	0.013
PJ1397	550J	1397	0.013

* THE ITEM IS MADE-TO-ORDER, NOT IN STOCK. PLEASE REFER TO GATES E-COMMERCE WEBSITE FOR UPDATED INFORMATION



53 MICRO-V - PJ

DESCRIPTION DIN 7867	RMA	EFFECTIVE LENGTH (MM)	WEIGHT(KG)
PJ1428	562J	1428	0.013
PJ1439	567J	1439	0.013
PJ1473	580J	1473	0.014
PJ1549	610J	1549	0.014
PJ1600	630J	1600	0.016
PJ1651	650J	1651	0.016
PJ1663	655J	1663	0.016
PJ1752	690J	1752	0.017
PJ1854	730J	1854	0.017
PJ1895	746J	1895	0.018
PJ1910	752J	1910	0.018
PJ1930	760J	1930	0.018
PJ1956	770J	1956	0.018
PJ1981	780J	1981	0.019
PJ1992	784J	1992	0.019
PJ2083	820J	2083	0.020
PJ2210	870J	2210	0.022
PJ2337	920J	2337	0.022
PJ2489	980J	2489	0.023

STANDARD AVAILABLE IN NUMBER OF RIBS														
# of ribs	4	5	6	7	8	9	10	12	14	15	16	18	20	24
PJ	x	x	x	x	x	x	x	x	x	x	x	x	x	x
PL	x	x	x	x	x	x	x	x	x	x	x	x	x	x
PM	x	x	x	x	x	x	x	x	x	x	x	x	x	x

* THE ITEM IS MADE-TO-ORDER, NOT IN STOCK. PLEASE REFER TO GATES E-COMMERCE WEBSITE FOR UPDATED INFORMATION



54 MICRO-V - PK

DESCRIPTION DIN 7867	EFFECTIVE LENGTH (MM)	WEIGHT (KG)
PK630	630	0.010
PK650	650	0.010
PK675	675	0.011
PK698	698	0.011
PK700	700	0.011
PK730	730	0.012
PK755	755	0.012
PK775	775	0.012
PK800	800	0.013
PK812	812	0.013
PK830	830	0.013
PK845	845	0.013
PK865	865	0.014
PK870	870	0.014
PK875	875	0.014
PK885	885	0.014
PK890	890	0.014
PK920	920	0.014
PK925	925	0.015
PK950	950	0.015
PK954	954	0.015
PK963	963	0.015
PK970	970	0.016
PK1000	1000	0.016
PK1015	1015	0.016
PK1035	1035	0.016
PK1060	1060	0.017
PK1080	1080	0.017
PK1090	1090	0.017
PK1125	1125	0.018
PK1145	1145	0.018
PK1150	1150	0.018
PK1165	1165	0.018
PK1190	1190	0.019
PK1200	1200	0.019
PK1222	1222	0.019
PK1230	1230	0.019
PK1245	1245	0.020
PK1270	1270	0.020
PK1300	1300	0.020
PK1330	1330	0.021
PK1335	1335	0.021
PK1345	1345	0.021
PK1385	1385	0.022
PK1420	1420	0.022
PK1460	1460	0.023
PK1470	1470	0.023

DESCRIPTION DIN 7867	EFFECTIVE LENGTH (MM)	WEIGHT (KG)
PK1480	1480	0.023
PK1490	1490	0.023
PK1520	1520	0.024
PK1555	1555	0.024
PK1560	1560	0.025
PK1570	1570	0.025
PK1610	1610	0.025
PK1655	1655	0.026
PK1690	1690	0.027
PK1700	1700	0.027
PK1725	1725	0.027
PK1755	1755	0.028
PK1800	1800	0.028
PK1860	1860	0.029
PK1885	1885	0.030
PK1890	1890	0.030
PK1900	1900	0.030
PK1930	1930	0.030
PK1980	1980	0.031
PK2050	2050	0.032
PK2080	2080	0.033
PK2120	2120	0.033
PK2145	2145	0.034
PK2235	2235	0.035
PK2280	2280	0.036
PK2330	2330	0.037
PK2420	2420	0.038
PK2490	2490	0.039

Only available as slabs.

* THE ITEM IS MADE-TO-ORDER, NOT IN STOCK. PLEASE REFER TO GATES E-COMMERCE WEBSITE FOR UPDATED INFORMATION



55 MICRO-V - PL

DESCRIPTION DIN 7867	RMA	EFFECTIVE LENGTH (MM)	WEIGHT (KG)
PL954	375L	954	0.033
PL991	390L	991	0.035
PL1075	423L	1075	0.038
PL1270	500L	1270	0.045
PL1333	525L	1333	0.046
PL1371	540L	1371	0.048
PL1397	550L	1397	0.049
PL1422	560L	1422	0.049
PL1562	615L	1562	0.054
PL1613	635L	1613	0.057
PL1664	655L	1664	0.057
PL1715	675L	1715	0.060
PL1765	695L	1765	0.061
PL1803	710L	1803	0.065
PL1842	725L	1842	0.066
PL1943	765L	1943	0.067
PL1981	780L	1981	0.068
PL2019	795L	2019	0.069
PL2070	815L	2070	0.071
PL2096	825L	2096	0.075
PL2134	840L	2134	0.077
PL2197	865L	2197	0.077
PL2235	880L	2235	0.077
PL2324	915L	2324	0.064
PL2362	930L	2362	0.064
PL2476	975L	2476	0.068
PL2515	990L	2515	0.072
PL2705	1065L	2705	0.077
PL2743	1080L	2743	0.080
PL2845	1120L	2845	0.080
PL2895	1140L	2895	0.080
PL2921	1150L	2921	0.080
PL2997	1180L	2997	0.085
PL3086	1215L	3086	0.089
PL3125	1230L	3125	0.093
PL3289	1295L	3289	0.093
PL3327	1310L	3327	0.386
PL3493	1375L	3493	0.097
PL3696	1455L	3696	0.106

STANDARD AVAILABLE IN NUMBER OF RIBS														
# of ribs	4	5	6	7	8	9	10	12	14	15	16	18	20	24
PJ	x	x	x	x	x	x	x	x	x	x	x	x	x	x
PL	x	x	x	x	x	x	x	x	x	x	x	x	x	x
PM	x	x	x	x	x	x	x	x	x	x	x	x	x	x

* THE ITEM IS MADE-TO-ORDER, NOT IN STOCK. PLEASE REFER TO GATES E-COMMERCE WEBSITE FOR UPDATED INFORMATION



56 MICRO-V - PM

DESCRIPTION DIN 7867	RMA	EFFECTIVE LENGTH (MM)	WEIGHT (KG)
PM2286	900M	2286	0.263
PM2388	940M	2388	0.276
PM2515	990M	2515	0.288
PM2693	1060M	2693	0.293
PM2832	1115M	2832	0.325
PM2921	1150M	2921	0.335
PM3010	1185M	3010	0.348
PM3124	1230M	3124	0.361
PM3327	1310M	3327	0.386
PM3531	1390M	3531	0.407
PM3734	1470M	3734	0.433
PM4089	1610M	4089	0.471
PM4191	1650M	4191	0.484
PM4470	1760M	4470	0.517
PM4648	1830M	4648	0.539
PM5029	1980M	5029	0.581
PM5410	2130M	5410	0.628
PM6121	2410M	6121	0.708
PM6502	2560M	6502	0.751
PM6883	2710M	6883	0.798
PM7646	3010M	7646	0.887
PM8408	3310M	8408	0.976
PM9169	3610M	9169	1.061
PM9931	3910M	9931	1.149

STANDARD AVAILABLE IN NUMBER OF RIBS														
# of Ribs	4	5	6	7	8	9	10	12	14	15	16	18	20	24
PJ	x	x	x	x	x	x	x	x	x	x	x	x	x	x
PL	x	x	x	x	x	x	x	x	x	x	x	x	x	x
PM	x	x	x	x	x	x	x	x	x	x	x	x	x	x

* THE ITEM IS MADE-TO-ORDER, NOT IN STOCK. PLEASE REFER TO GATES E-COMMERCE WEBSITE FOR UPDATED INFORMATION





7. SYNCHRONOUS BELTS SIZE LIST



POLY CHAIN CARBON VOLT BELTS - 8MGT AND 14MGT

Recommended Sprockets

Use Taper-Lock type Poly Chain GT Sprockets when designing a new Poly Chain Carbon VOLT belt drive system.

NOTES: 8M and 14M Poly Chain Carbon VOLT belts are static conductive in accordance with ISO 9653 and for conditions described in the Directive 2014/34/EU-ATEX. Poly Chain Carbon VOLT belt part numbers follow a similar notation to Poly Chain GT Carbon belts: part number 14GTV-4410-20 denotes a 14mm pitch, V: Poly Chain Carbon VOLT antistatic construction, 4410mm pitch length and 20mm width. Poly Chain Carbon VOLT belts can be used on existing drives as replacement for previous generation Poly Chain GT Carbon or Poly Chain GT2 belts. Synchronous pitch length is always a multiple of the belt pitch.

WARNING: Always utilize Taper-Lock type Poly Chain GT Sprockets when designing a new Poly Chain GT Carbon VOLT belt drive system. Use of non-Gates manufactured sprockets is not recommended: Gates Poly Chain GT sprockets are manufactured, specified and tested to fully support the maximum capabilities of the Poly Chain GT Carbon VOLT belt. Product performance cannot be guaranteed when non-Gates sprockets are used.

Item description build up: pitch-length-width

8MM PITCH - 12 MM WIDE					
Item description	Product Number	Teeth	Pitch Length (mm)	Weight (kg)	Stock
8MGTV-640-12	9239-00080	80	640	0.035	Y
8MGTV-720-12	9239-00090	90	720	0.040	Y
8MGTV-800-12	9239-00100	100	800	0.044	Y
8MGTV-896-12	9239-00112	112	896	0.050	Y
8MGTV-960-12	9239-00120	120	960	0.054	Y
8MGTV-1000-12	9239-00125	125	1000	0.056	Y
8MGTV-1040-12	9239-00130	130	1040	0.058	Y
8MGTV-1120-12	9239-00140	140	1120	0.062	Y
8MGTV-1200-12	9239-00150	150	1200	0.070	Y
8MGTV-1224-12	9239-00153	153	1224	0.069	Y
8MGTV-1280-12	9239-00160	160	1280	0.071	Y
8MGTV-1440-12	9239-00180	180	1440	0.080	Y
8MGTV-1600-12	9239-00200	200	1600	0.089	Y
8MGTV-1760-12	9239-00220	220	1760	0.097	Y
8MGTV-1792-12	9239-00224	224	1792	0.099	Y
8MGTV-2000-12	9239-00250	250	2000	0.112	Y
8MGTV-2200-12	9239-00275	275	2200	0.123	Y
8MGTV-2240-12	9239-00280	280	2240	0.125	Y
8MGTV-2400-12	9239-00300	300	2400	0.133	Y
8MGTV-2520-12	9239-00315	315	2520	0.140	Y
8MGTV-2600-12	9239-00325	325	2600	0.144	Y
8MGTV-2800-12	9239-00350	350	2800	0.155	Y
8MGTV-2840-12	9239-00355	355	2840	0.157	Y
8MGTV-3048-12	9239-00381	381	3048	0.170	Y
8MGTV-3200-12	9239-00400	400	3200	0.178	Y
8MGTV-3280-12	9239-00410	410	3280	0.183	Y
8MGTV-3600-12	9239-00450	450	3600	0.200	Y
8MGTV-4000-12	9239-00500	500	4000	0.221	Y
8MGTV-4400-12	9239-00550	550	4400	0.245	Y
8MGTV-4480-12	9239-00560	560	4480	0.249	Y

8MM PITCH - 21 MM WIDE					
Item description	Product Number	Teeth	Pitch Length (mm)	Weight (kg)	Stock
8MGTV-640-21	9239-01080	80	640	0.062	Y
8MGTV-720-21	9239-01090	90	720	0.070	Y
8MGTV-800-21	9239-01100	100	800	0.080	Y
8MGTV-896-21	9239-01112	112	896	0.090	Y
8MGTV-960-21	9239-01120	120	960	0.094	Y
8MGTV-1000-21	9239-01125	125	1000	0.100	Y
8MGTV-1040-21	9239-01130	130	1040	0.102	Y
8MGTV-1120-21	9239-01140	140	1120	0.109	Y
8MGTV-1200-21	9239-01150	150	1200	0.117	Y
8MGTV-1224-21	9239-01153	153	1224	0.121	Y
8MGTV-1280-21	9239-01160	160	1280	0.124	Y
8MGTV-1440-21	9239-01180	180	1440	0.144	Y
8MGTV-1600-21	9239-01200	200	1600	0.160	Y
8MGTV-1760-21	9239-01220	220	1760	0.169	Y
8MGTV-1792-21	9239-01224	224	1792	0.190	Y
8MGTV-2000-21	9239-01250	250	2000	0.194	Y
8MGTV-2200-21	9239-01275	275	2200	0.214	Y
8MGTV-2240-21	9239-01280	280	2240	0.218	Y
8MGTV-2400-21	9239-01300	300	2400	0.233	Y
8MGTV-2520-21	9239-01315	315	2520	0.244	Y
8MGTV-2600-21	9239-01325	325	2600	0.252	Y
8MGTV-2800-21	9239-01350	350	2800	0.271	Y
8MGTV-2840-21	9239-01355	355	2840	0.274	Y
8MGTV-3048-21	9239-01381	381	3048	0.297	Y
8MGTV-3200-21	9239-01400	400	3200	0.312	Y
8MGTV-3280-21	9239-01410	410	3280	0.319	Y
8MGTV-3600-21	9239-01450	450	3600	0.349	Y
8MGTV-4000-21	9239-01500	500	4000	0.387	Y
8MGTV-4400-21	9239-01550	550	4400	0.428	Y
8MGTV-4480-21	9239-01560	560	4480	0.436	Y

POLY CHAIN CARBON VOLT



POLY CHAIN CARBON VOLT BELTS - 8MGT AND 14MGT

8MM PITCH - 36 MM WIDE					
Item description	Product Number	Teeth	Pitch Length (mm)	Weight (kg)	Stock
8MGTV-640-36	9239-02080	80	640	0.106	Y
8MGTV-720-36	9239-02090	90	720	0.120	Y
8MGTV-800-36	9239-02100	100	800	0.133	Y
8MGTV-896-36	9239-02112	112	896	0.160	Y
8MGTV-960-36	9239-02120	120	960	0.161	Y
8MGTV-1000-36	9239-02125	125	1000	0.180	Y
8MGTV-1040-36	9239-02130	130	1040	0.174	Y
8MGTV-1120-36	9239-02140	140	1120	0.186	Y
8MGTV-1200-36	9239-02150	150	1200	0.200	Y
8MGTV-1224-36	9239-02153	153	1224	0.206	Y
8MGTV-1280-36	9239-02160	160	1280	0.230	Y
8MGTV-1440-36	9239-02180	180	1440	0.260	Y
8MGTV-1600-36	9239-02200	200	1600	0.280	Y
8MGTV-1760-36	9239-02220	220	1760	0.290	Y
8MGTV-1792-36	9239-02224	224	1792	0.296	Y
8MGTV-2000-36	9239-02250	250	2000	0.360	Y
8MGTV-2200-36	9239-02275	275	2200	0.367	Y
8MGTV-2240-36	9239-02280	280	2240	0.373	Y
8MGTV-2400-36	9239-02300	300	2400	0.399	Y
8MGTV-2520-36	9239-02315	315	2520	0.418	Y
8MGTV-2600-36	9239-02325	325	2600	0.431	Y
8MGTV-2800-36	9239-02350	350	2800	0.463	Y
8MGTV-2840-36	9239-02355	355	2840	0.470	Y
8MGTV-3048-36	9239-02381	381	3048	0.508	Y
8MGTV-3200-36	9239-02400	400	3200	0.534	Y
8MGTV-3280-36	9239-02410	410	3280	0.547	Y
8MGTV-3600-36	9239-02450	450	3600	0.598	Y
8MGTV-4000-36	9239-02500	500	4000	0.663	Y
8MGTV-4400-36	9239-02550	550	4400	0.733	Y
8MGTV-4480-36	9239-02560	560	4480	0.746	Y

8MM PITCH - 62 MM WIDE					
Item description	Product Number	Teeth	Pitch Length (mm)	Weight (kg)	Stock
8MGTV-640-62	9239-03080	80	640	0.200	Y
8MGTV-720-62	9239-03090	90	720	0.211	Y
8MGTV-800-62	9239-03100	100	800	0.233	Y
8MGTV-896-62	9239-03112	112	896	0.255	Y
8MGTV-960-62	9239-03120	120	960	0.277	Y
8MGTV-1000-62	9239-03125	125	1000	0.288	Y
8MGTV-1040-62	9239-03130	130	1040	0.299	Y
8MGTV-1120-62	9239-03140	140	1120	0.322	Y
8MGTV-1200-62	9239-03150	150	1200	0.344	Y
8MGTV-1224-62	9239-03153	153	1224	0.355	Y
8MGTV-1280-62	9239-03160	160	1280	0.366	Y
8MGTV-1440-62	9239-03180	180	1440	0.410	Y
8MGTV-1600-62	9239-03200	200	1600	0.490	Y
8MGTV-1760-62	9239-03220	220	1760	0.499	Y
8MGTV-1792-62	9239-03224	224	1792	0.510	Y
8MGTV-2000-62	9239-03250	250	2000	0.576	Y
8MGTV-2200-62	9239-03275	275	2200	0.632	Y
8MGTV-2240-62	9239-03280	280	2240	0.643	Y
8MGTV-2400-62	9239-03300	300	2400	0.687	Y
8MGTV-2520-62	9239-03315	315	2520	0.720	Y
8MGTV-2600-62	9239-03325	325	2600	0.742	Y
8MGTV-2800-62	9239-03350	350	2800	0.798	Y
8MGTV-2840-62	9239-03355	355	2840	0.809	Y
8MGTV-3048-62	9239-03381	381	3048	0.875	Y
8MGTV-3200-62	9239-03400	400	3200	0.919	Y
8MGTV-3280-62	9239-03410	410	3280	0.942	Y
8MGTV-3600-62	9239-03450	450	3600	1.030	Y
8MGTV-4000-62	9239-03500	500	4000	1.141	Y
8MGTV-4400-62	9239-03550	550	4400	1.263	Y
8MGTV-4480-62	9239-03560	560	4480	1.285	Y

POLY CHAIN
CARBON VOLT

POLY CHAIN CARBON VOLT BELTS - 8MGT AND 14MGT

14MM PITCH - 20 MM WIDE						14MM PITCH - 37 MM WIDE					
Item description	Product Number	Teeth	Pitch Length (mm)	Weight (kg)	Stock	Item description	Product Number	Teeth	Pitch Length (mm)	Weight (kg)	Stock
14MGTV-994-20	9239-04071	71	994	0.158	Y	14MGTV-994-37	9239-05071	71	994	0.291	Y
14MGTV-1120-20	9239-04080	80	1120	0.176	Y	14MGTV-1120-37	9239-05080	80	1120	0.324	Y
14MGTV-1190-20	9239-04085	85	1190	0.186	Y	14MGTV-1190-37	9239-05085	85	1190	0.344	Y
14MGTV-1260-20	9239-04090	90	1260	0.197	Y	14MGTV-1260-37	9239-05090	90	1260	0.364	Y
14MGTV-1400-20	9239-04100	100	1400	0.218	Y	14MGTV-1400-37	9239-05100	100	1400	0.218	Y
14MGTV-1568-20	9239-04112	112	1568	0.247	Y	14MGTV-1568-37	9239-05112	112	1568	0.440	Y
14MGTV-1610-20	9239-04115	115	1610	0.251	Y	14MGTV-1610-37	9239-05115	115	1610	0.463	Y
14MGTV-1750-20	9239-04125	125	1750	0.276	Y	14MGTV-1750-37	9239-05125	125	1750	0.390	Y
14MGTV-1890-20	9239-04135	135	1890	0.297	Y	14MGTV-1890-37	9239-05135	135	1890	0.549	Y
14MGTV-1960-20	9239-04140	140	1960	0.308	Y	14MGTV-1960-37	9239-05140	140	1960	0.567	Y
14MGTV-2100-20	9239-04150	150	2100	0.329	Y	14MGTV-2100-37	9239-05150	150	2100	0.608	Y
14MGTV-2240-20	9239-04160	160	2240	0.351	Y	14MGTV-2240-37	9239-05160	160	2240	0.648	Y
14MGTV-2310-20	9239-04165	165	2310	0.361	Y	14MGTV-2310-37	9239-05165	165	2310	0.668	Y
14MGTV-2380-20	9239-04170	170	2380	0.372	Y	14MGTV-2380-37	9239-05170	170	2380	0.688	Y
14MGTV-2450-20	9239-04175	175	2450	0.383	Y	14MGTV-2450-37	9239-05175	175	2450	0.707	Y
14MGTV-2520-20	9239-04180	180	2520	0.393	Y	14MGTV-2520-37	9239-05180	180	2520	0.727	Y
14MGTV-2590-20	9239-04185	185	2590	0.404	Y	14MGTV-2590-37	9239-05185	185	2590	0.747	Y
14MGTV-2660-20	9239-04190	190	2660	0.415	Y	14MGTV-2660-37	9239-05190	190	2660	0.767	Y
14MGTV-2730-20	9239-04195	195	2730	0.426	Y	14MGTV-2730-37	9239-05195	195	2730	0.787	Y
14MGTV-2800-20	9239-04200	200	2800	0.440	Y	14MGTV-2800-37	9239-05200	200	2800	0.813	Y
14MGTV-2828-20	9239-04202	202	2828	0.443	Y	14MGTV-2828-37	9239-05202	202	2828	0.820	Y
14MGTV-3136-20	9239-04224	224	3136	0.490	Y	14MGTV-3136-37	9239-05224	224	3136	0.906	Y
14MGTV-3304-20	9239-04236	236	3304	0.518	Y	14MGTV-3304-37	9239-05236	236	3304	0.959	Y
14MGTV-3360-20	9239-04240	240	3360	0.526	Y	14MGTV-3360-37	9239-05240	240	3360	0.972	Y
14MGTV-3500-20	9239-04250	250	3500	0.547	Y	14MGTV-3500-37	9239-05250	250	3500	1.011	Y
14MGTV-3850-20	9239-04275	275	3850	0.604	Y	14MGTV-3850-37	9239-05275	275	3850	1.117	Y
14MGTV-3920-20	9239-04280	280	3920	0.615	Y	14MGTV-3920-37	9239-05280	280	3920	1.137	Y
14MGTV-4326-20	9239-04309	309	4326	0.676	Y	14MGTV-4326-37	9239-05309	309	4326	1.249	Y
14MGTV-4410-20	9239-04315	315	4410	0.690	Y	14MGTV-4410-37	9239-05315	315	4410	1.276	Y



POLY CHAIN CARBON VOLT BELTS - 8MGT AND 14MGT

POLY CHAIN
CARBON VOLT

14MM PITCH - 68 MM WIDE					
Item description	Product Number	Teeth	Pitch Length (mm)	Weight (kg)	Stock
14MGTV-994-68	9239-06071	71	994	0.535	Y
14MGTV-1120-68	9239-06080	80	1120	0.596	Y
14MGTV-1190-68	9239-06085	85	1190	0.632	Y
14MGTV-1260-68	9239-06090	90	1260	0.668	Y
14MGTV-1400-68	9239-06100	100	1400	0.741	Y
14MGTV-1568-68	9239-06112	112	1568	0.810	Y
14MGTV-1610-68	9239-06115	115	1610	0.851	Y
14MGTV-1750-68	9239-06125	125	1750	0.931	Y
14MGTV-1890-68	9239-06135	135	1890	1.008	Y
14MGTV-1960-68	9239-06140	140	1960	1.045	Y
14MGTV-2100-68	9239-06150	150	2100	1.118	Y
14MGTV-2240-68	9239-06160	160	2240	1.191	Y
14MGTV-2310-68	9239-06165	165	2310	1.227	Y
14MGTV-2380-68	9239-06170	170	2380	1.263	Y
14MGTV-2450-68	9239-06175	175	2450	1.300	Y
14MGTV-2520-68	9239-06180	180	2520	1.336	Y
14MGTV-2590-68	9239-06185	185	2590	1.373	Y
14MGTV-2660-68	9239-06190	190	2660	1.409	Y
14MGTV-2730-68	9239-06195	195	2730	1.446	Y
14MGTV-2800-68	9239-06200	200	2800	1.494	Y
14MGTV-2828-68	9239-06202	202	2828	1.506	Y
14MGTV-3136-68	9239-06224	224	3136	1.664	Y
14MGTV-3304-68	9239-06236	236	3304	1.761	Y
14MGTV-3360-68	9239-06240	240	3360	1.786	Y
14MGTV-3500-68	9239-06250	250	3500	1.858	Y
14MGTV-3850-68	9239-06275	275	3850	2.053	Y
14MGTV-3920-68	9239-06280	280	3920	2.089	Y
14MGTV-4326-68	9239-06309	309	4326	2.296	Y
14MGTV-4410-68	9239-06315	315	4410	2.344	Y

14MM PITCH - 90 MM WIDE					
Item description	Product Number	Teeth	Pitch Length (mm)	Weight (kg)	Stock
14MGTV-994-90	9239-07071	71	994	0.708	Y
14MGTV-1120-90	9239-07080	80	1120	0.788	Y
14MGTV-1190-90	9239-07085	85	1190	0.836	Y
14MGTV-1260-90	9239-07090	90	1260	0.884	Y
14MGTV-1400-90	9239-07100	100	1400	0.981	Y
14MGTV-1568-90	9239-07112	112	1568	1.109	Y
14MGTV-1610-90	9239-07115	115	1610	1.126	Y
14MGTV-1750-90	9239-07125	125	1750	1.195	Y
14MGTV-1890-90	9239-07135	135	1890	1.334	Y
14MGTV-1960-90	9239-07140	140	1960	1.383	Y
14MGTV-2100-90	9239-07150	150	2100	1.479	Y
14MGTV-2240-90	9239-07160	160	2240	1.576	Y
14MGTV-2310-90	9239-07165	165	2310	1.624	Y
14MGTV-2380-90	9239-07170	170	2380	1.672	Y
14MGTV-2450-90	9239-07175	175	2450	1.720	Y
14MGTV-2520-90	9239-07180	180	2520	1.768	Y
14MGTV-2590-90	9239-07185	185	2590	1.817	Y
14MGTV-2660-90	9239-07190	190	2660	1.865	Y
14MGTV-2730-90	9239-07195	195	2730	1.913	Y
14MGTV-2800-90	9239-07200	200	2800	1.977	Y
14MGTV-2828-90	9239-07202	202	2828	1.993	Y
14MGTV-3136-90	9239-07224	224	3136	2.202	Y
14MGTV-3304-90	9239-07236	236	3304	2.331	Y
14MGTV-3360-90	9239-07240	240	3360	2.363	Y
14MGTV-3500-90	9239-07250	250	3500	2.460	Y
14MGTV-3850-90	9239-07275	275	3850	2.717	Y
14MGTV-3920-90	9239-07280	280	3920	2.765	Y
14MGTV-4326-90	9239-07309	309	4326	3.038	Y
14MGTV-4410-90	9239-07315	315	4410	3.102	Y



POLY CHAIN CARBON VOLT BELTS - 8MGT AND 14MGT

14MM PITCH - 125 MM WIDE					
Item description	Product Number	Teeth	Pitch Length (mm)	Weight (kg)	Stock
14MGTV-994-125	9239-08071	71	994	0.983	Y
14MGTV-1120-125	9239-08080	80	1120	1.094	Y
14MGTV-1190-125	9239-08085	85	1190	1.161	Y
14MGTV-1260-125	9239-08090	90	1260	1.228	Y
14MGTV-1400-125	9239-08100	100	1400	1.362	Y
14MGTV-1568-125	9239-08112	112	1568	1.541	Y
14MGTV-1610-125	9239-08115	115	1610	1.563	Y
14MGTV-1750-125	9239-08125	125	1750	1.719	Y
14MGTV-1890-125	9239-08135	135	1890	1.853	Y
14MGTV-1960-125	9239-08140	140	1960	1.920	Y
14MGTV-2100-125	9239-08150	150	2100	2.054	Y
14MGTV-2240-125	9239-08160	160	2240	2.188	Y
14MGTV-2310-125	9239-08165	165	2310	2.255	Y
14MGTV-2380-125	9239-08170	170	2380	2.322	Y
14MGTV-2450-125	9239-08175	175	2450	2.389	Y
14MGTV-2520-125	9239-08180	180	2520	2.456	Y
14MGTV-2590-125	9239-08185	185	2590	2.523	Y
14MGTV-2660-125	9239-08190	190	2660	2.590	Y
14MGTV-2730-125	9239-08195	195	2730	2.657	Y
14MGTV-2800-125	9239-08200	200	2800	2.746	Y
14MGTV-2828-125	9239-08202	202	2828	2.768	Y
14MGTV-3136-125	9239-08224	224	3136	3.059	Y
14MGTV-3304-125	9239-08236	236	3304	3.237	Y
14MGTV-3360-125	9239-08240	240	3360	3.282	Y
14MGTV-3500-125	9239-08250	250	3500	3.416	Y
14MGTV-3850-125	9239-08275	275	3850	3.773	Y
14MGTV-3920-125	9239-08280	280	3920	3.840	Y
14MGTV-4326-125	9239-08309	309	4326	4.219	Y
14MGTV-4410-125	9239-08315	315	4410	4.309	Y



POLY CHAIN GT CARBON BELTS - 8M SHORT LENGTH

Recommended Sprockets

Poly Chain GT Sprockets

NOTES: Poly Chain GT Carbon belts must be used with sprockets of the same pitch and profile. Poly Chain GT Carbon part numbers are comprised of pitch, pitch length and width. For example, part number 8MC-248-12 denotes an 8mm pitch, 248mm pitch length and 12mm width. Belt pitch is the distance in millimeters between two adjacent tooth centers as measured on the pitch line of the belt. Belt pitch length is the total length (circumference) in millimeters as measured along the pitch line. The theoretical pitch line of a Poly Chain GT belt lies within the tensile member. Synchronous pitch length is always a multiple of the belt pitch.

Item description build up: pitch-length-width

8MM PITCH - 11.2 MM WIDE					
Item description	Product Number	Teeth	Pitch Length (mm)	Weight (kg)	Stock
8MC-248-11.2	9270-01030	31	248	0.010	Y
8MC-288-11.2	9270-01029	36	288	0.015	Y
8MC-352-11.2	9270-01027	44	352	0.015	Y
8MC-416-11.2	9270-01031	52	416	0.020	Y
8MC-456-11.2	9270-01028	57	456	0.020	Y
8MC-480-11.2	9270-01033	60	480	0.020	Y
8MC-544-11.2	9270-01032	68	544	0.025	Y
8MC-608-11.2	9270-01034	76	608	0.025	Y

8MM PITCH - 21 MM WIDE					
Item description	Product Number	Teeth	Pitch Length (mm)	Weight (kg)	Stock
8MC-248-21	9270-01097	31	248	0.019	Y
8MC-288-21	9270-01130	36	288	0.028	Y
8MC-352-21	9270-01046	44	352	0.028	Y
8MC-416-21	9270-01038	52	416	0.035	Y
8MC-456-21	9270-01047	57	456	0.040	Y
8MC-480-21	9270-01048	60	480	0.040	Y
8MC-544-21	9270-01144	68	544	0.045	Y
8MC-608-21	9270-01148	76	608	0.050	Y

8MM PITCH - 36 MM WIDE					
Item description	Product Number	Teeth	Pitch Length (mm)	Weight (kg)	Stock
8MC-248-36	9270-01124	31	248	0.032	Y
8MC-288-36	9270-01131	36	288	0.048	Y
8MC-352-36	9270-01133	44	352	0.048	Y
8MC-416-36	9270-01135	52	416	0.064	Y
8MC-456-36	9270-01137	57	456	0.064	Y
8MC-480-36	9270-01139	60	480	0.064	Y
8MC-544-36	9270-01141	68	544	0.080	Y
8MC-608-36	9270-01106	76	608	0.080	Y

8MM PITCH - 62 MM WIDE					
Item description	Product Number	Teeth	Pitch Length (mm)	Weight (kg)	Stock
8MC-248-62	9270-01129	31	248	0.055	Y
8MC-288-62	9270-01132	36	288	0.083	Y
8MC-352-62	9270-01134	44	352	0.083	Y
8MC-416-62	9270-01136	52	416	0.111	Y
8MC-456-62	9270-01138	57	456	0.111	Y
8MC-480-62	9270-01140	60	480	0.111	Y
8MC-544-62	9270-01142	68	544	0.138	Y
8MC-608-62	9270-01143	76	608	0.138	Y



POLY CHAIN GT CARBON BELTS - 5MGT

Recommended Sprockets

PowerGrip GT and Poly Chain GT Sprockets

NOTES: 5M Poly Chain GT part numbers are comprised of pitch, pitch length and width. For example; part number 5MGTC-425-15 denotes a 5mm pitch, 425mm pitch length and 15mm width. Belt pitch is the distance in millimeters between two adjacent tooth centers as measured on the pitch line of the belt. Belt pitch length is the total length (circumference) in millimeters as measured along the pitch line. The theoretical pitch line of a Poly Chain GT Carbon belt lies within the tensile member. Synchronous pitch length is always a multiple of the belt pitch.

WARNING: 5M Poly Chain GT belts must be used with 5MGT sprockets. Consult your local Gates Field Representative for drive design assistance

Item description build up: pitch-length-width

5MM PITCH - 9 MM WIDE					
Item description	Product Number	Teeth	Pitch Length (mm)	Weight (kg)	Stock
5MGTC-300-9	9270-06001	60	300	0.009	Y
5MGTC-375-9	9270-06005	75	375	0.010	Y
5MGTC-425-9	9270-06008	85	425	0.012	Y
5MGTC-500-9	9270-06012	100	500	0.013	Y
5MGTC-535-9	9270-06015	107	535	0.015	Y
5MGTC-600-9	9270-06018	120	600	0.017	Y
5MGTC-635-9	9270-06021	127	635	0.017	Y
5MGTC-700-9	9270-06024	140	700	0.018	Y
5MGTC-815-9	9270-06027	163	815	0.021	Y

5MM PITCH - 15 MM WIDE					
Item description	Product Number	Teeth	Pitch Length (mm)	Weight (kg)	Stock
5MGTC-300-15	9270-06002	60	300	0.014	Y
5MGTC-375-15	9270-06006	75	375	0.017	Y
5MGTC-425-15	9270-06009	85	425	0.019	Y
5MGTC-500-15	9270-06013	100	500	0.022	Y
5MGTC-535-15	9270-06016	107	535	0.025	Y
5MGTC-600-15	9270-06019	120	600	0.027	Y
5MGTC-635-15	9270-06022	127	635	0.027	Y
5MGTC-700-15	9270-06025	140	700	0.030	Y
5MGTC-815-15	9270-06028	163	815	0.035	Y

5MM PITCH - 25 MM WIDE					
Item description	Product Number	Teeth	Pitch Length (mm)	Weight (kg)	Stock
5MGTC-300-25	9270-06004	60	300	0.023	Y
5MGTC-375-25	9270-06007	75	375	0.027	Y
5MGTC-425-25	9270-06010	85	425	0.032	Y
5MGTC-500-25	9270-06014	100	500	0.036	Y
5MGTC-535-25	9270-06017	107	535	0.041	Y
5MGTC-600-25	9270-06020	120	600	0.045	Y
5MGTC-635-25	9270-06023	127	635	0.045	Y
5MGTC-700-25	9270-06026	140	700	0.050	Y
5MGTC-815-25	9270-06029	163	815	0.059	Y



POLY CHAIN GT CARBON - EXTENDED LENGTH BELTS

Recommended Sprockets

Poly Chain GT Sprockets - 14M

NOTES: Poly Chain GT Carbon Extended Length Belts are Standard/Non-Stock and may require lead time. Please check with Customer Service for availability. Poly Chain GT Carbon Extended Length belt part numbers are comprised of pitch, pitch length, extended length indication, and width: part number 14MGT-6890-90EL denotes a 14mm pitch, 6860mm pitch length, and 90mm width in extended length construction.

WARNING: Always utilize Taper-Lock type Poly Chain GT Sprockets when designing a new Poly Chain GT Carbon Extended Length belt drive system. Use of non-Gates manufactured sprockets is not recommended and product performance cannot be guaranteed when non-Gates sprockets are used.

Item description build up: pitch-length-width

14MM PITCH - 37 MM WIDE					
Item description	Product Number	Teeth	Pitch Length (mm)	Weight (kg)	Stock
14MGT-4578-37EL	9268-02001	327	4578	2.170	N
14MGT-4956-37EL	9268-02004	354	4956	1.422	N
14MGT-5320-37EL	9268-02007	380	5320	1.526	N
14MGT-5740-37EL	9268-02010	410	5740	1.647	N
14MGT-6160-37EL	9268-02013	440	6160	1.769	N
14MGT-6860-37EL	9268-02016	490	6860	1.967	N
14MGT-7560-37EL	9268-02025	540	7560	2.190	N
14MGT-8260-37EL	9268-02029	590	8260	2.400	N
14MGT-8960-37EL	9268-02033	640	8960	2.600	N
14MGT-9660-37EL	9268-02037	690	9660	2.800	N

14MM PITCH - 68 MM WIDE					
Item description	Product Number	Teeth	Pitch Length (mm)	Weight (kg)	Stock
14MGT-4578-68EL	9268-02002	327	4578	2.412	N
14MGT-4956-68EL	9268-02005	354	4956	2.615	N
14MGT-5320-68EL	9268-02008	380	5320	2.804	N
14MGT-5740-68EL	9268-02011	410	5740	3.029	N
14MGT-6160-68EL	9268-02014	440	6160	3.249	N
14MGT-6860-68EL	9268-02017	490	6860	3.618	N
14MGT-7560-68EL	9268-02026	540	7560	4.020	N
14MGT-8260-68EL	9268-02030	590	8260	4.400	N
14MGT-8960-68EL	9268-02034	640	8960	4.770	N
14MGT-9660-68EL	9268-02038	690	9660	5.140	N

14MM PITCH - 90 MM WIDE					
Item description	Product Number	Teeth	Pitch Length (mm)	Weight (kg)	Stock
14MGT-4578-90EL	9268-02003	327	4578	3.195	N
14MGT-4956-90EL	9268-02006	354	4956	3.461	N
14MGT-5320-90EL	9268-02009	380	5320	3.713	N
14MGT-5740-90EL	9268-02012	410	5740	4.005	N
14MGT-6160-90EL	9268-02015	440	6160	4.298	N
14MGT-6860-90EL	9268-02018	490	6860	4.788	N
14MGT-7560-90EL	9268-02027	540	7560	5.330	N
14MGT-8260-90EL	9268-02031	590	8260	5.820	N
14MGT-8960-90EL	9268-02035	640	8960	6.310	N
14MGT-9660-90EL	9268-02039	690	9660	6.800	N

14MM PITCH - 125 MM WIDE					
Item description	Product Number	Teeth	Pitch Length (mm)	Weight (kg)	Stock
14MGT-4578-125EL	9268-02019	327	4578	4.438	N
14MGT-4956-125EL	9268-02020	354	4956	5.230	N
14MGT-5320-125EL	9268-02021	380	5320	5.198	N
14MGT-5740-125EL	9268-02022	410	5740	5.606	N
14MGT-6160-125EL	9268-02023	440	6160	6.019	N
14MGT-6860-125EL	9268-02024	490	6860	6.704	N
14MGT-7560-125EL	9268-02028	540	7560	7.390	N
14MGT-8260-125EL	9268-02032	590	8260	8.070	N
14MGT-8960-125EL	9268-02036	640	8960	8.760	N
14MGT-9660-125EL	9268-02040	690	9660	9.440	N

POLY CHAIN CARBON
EXTENDED LENGTH

POLY CHAIN GT2 BELTS - 8MGT AND 14MGT

Recommended Sprockets

Poly Chain GT Sprockets - 8MGT and 14MGT

NOTES: Belt pitch is the distance in millimeters between two adjacent tooth centers as measured on the pitch line of the belt. Belt pitch length is the total length (circumference) in millimeters as measured along the pitch line. The theoretical pitch line of a Poly Chain GT2 belt lies within the tensile member. Poly Chain GT2 belts can be used on existing drives as replacement for previous generation Poly Chain GT belts. Belt pitch is the distance in millimeters between two adjacent tooth centers as measured on the pitch line of the belt. Belt pitch length is the total length (circumference) in millimeters as measured along the pitch line. The theoretical pitch line of a Poly Chain GT2 belt lies within the tensile member. Poly Chain GT2 part numbers are comprised of pitch, pitch length and width. For example, part number 14MGT-2450-37 denotes a 14mm pitch, 2450mm pitch length and 37mm width. Synchronous pitch length is always a multiple of the belt pitch.

WARNING: Always utilize Taper-Lock type Poly Chain GT Sprockets when replacing a Poly Chain GT2 belt drive system. Use of non-Gates manufactured sprockets is not recommended: Gates Poly Chain GT sprockets are manufactured, specified and tested to fully support the full capabilities of the Poly Chain belt. Product performance cannot be guaranteed when non-Gates sprockets are used.

Item description build up: pitch-length-width

8MM PITCH - 12 MM WIDE						8MM PITCH - 21 MM WIDE					
Item description	Product Number	Teeth	Pitch Length (mm)	Weight (kg)	Stock	Item description	Product Number	Teeth	Pitch Length (mm)	Weight (kg)	Stock
8MGT-640-12	9275-09017	80	640	0.036	Y	8MGT-640-21	9275-09018	80	640	0.062	Y
8MGT-720-12	9275-09025	90	720	0.040	Y	8MGT-720-21	9275-09026	90	720	0.070	Y
8MGT-800-12	9275-09033	100	800	0.044	Y	8MGT-800-21	9275-09034	100	800	0.080	Y
8MGT-896-12	9275-09041	112	896	0.050	Y	8MGT-896-21	9275-09042	112	896	0.090	Y
8MGT-960-12	9275-09045	120	960	0.058	Y	8MGT-960-21	9275-09046	120	960	0.101	Y
8MGT-1000-12	9275-09049	125	1000	0.060	Y	8MGT-1000-21	9275-09050	125	1000	0.100	Y
8MGT-1040-12	9275-09053	130	1040	0.062	Y	8MGT-1040-21	9275-09054	130	1040	0.109	Y
8MGT-1120-12	9275-09057	140	1120	0.070	Y	8MGT-1120-21	9275-09058	140	1120	0.109	Y
8MGT-1200-12	9275-09061	150	1200	0.070	Y	8MGT-1200-21	9275-09062	150	1200	0.120	Y
8MGT-1224-12	9275-09351	153	1224	0.073	Y	8MGT-1224-21	9275-09352	153	1224	0.129	Y
8MGT-1280-12	9275-09065	160	1280	0.071	Y	8MGT-1280-21	9275-09066	160	1280	0.130	Y
8MGT-1440-12	9275-09073	180	1440	0.086	Y	8MGT-1440-21	9275-09074	180	1440	0.144	Y
8MGT-1600-12	9275-09081	200	1600	0.100	Y	8MGT-1600-21	9275-09082	200	1600	0.160	Y
8MGT-1760-12	9275-09085	220	1760	0.106	Y	8MGT-1760-21	9275-09086	220	1760	0.185	Y
8MGT-1792-12	9275-09089	224	1792	0.100	Y	8MGT-1792-21	9275-09090	224	1792	0.190	Y
8MGT-2000-12	9275-09097	250	2000	0.120	Y	8MGT-2000-21	9275-09098	250	2000	0.210	Y
8MGT-2200-12	9275-09101	275	2200	0.132	Y	8MGT-2200-21	9275-09102	275	2200	0.231	Y
8MGT-2240-12	9275-09105	280	2240	0.130	Y	8MGT-2240-21	9275-09106	280	2240	0.230	Y
8MGT-2400-12	9275-09109	300	2400	0.140	Y	8MGT-2400-21	9275-09110	300	2400	0.250	Y
8MGT-2520-12	9275-09113	315	2520	0.150	Y	8MGT-2520-21	9275-09114	315	2520	0.260	Y
8MGT-2600-12	9275-09117	325	2600	0.156	Y	8MGT-2600-21	9275-09118	325	2600	0.273	Y
8MGT-2800-12	9275-09355	350	2800	0.168	Y	8MGT-2800-21	9275-09356	350	2800	0.294	Y
8MGT-2840-12	9275-09121	355	2840	0.170	Y	8MGT-2840-21	9275-09122	355	2840	0.290	Y
8MGT-3048-12	9275-09125	381	3048	0.183	Y	8MGT-3048-21	9275-09126	381	3048	0.320	Y
8MGT-3200-12	9275-09129	400	3200	0.190	Y	8MGT-3200-21	9275-09130	400	3200	0.330	Y
8MGT-3280-12	9275-09133	410	3280	0.197	Y	8MGT-3280-21	9275-09134	410	3280	0.344	Y
8MGT-3600-12	9275-09137	450	3600	0.210	Y	8MGT-3600-21	9275-09138	450	3600	0.370	Y
8MGT-4000-12	9275-09145	500	4000	0.240	Y	8MGT-4000-21	9275-09146	500	4000	0.410	Y
8MGT-4400-12	9275-09149	550	4400	0.264	Y	8MGT-4400-21	9275-09150	550	4400	0.462	Y
8MGT-4480-12	9275-09153	560	4480	0.260	Y	8MGT-4480-21	9275-09154	560	4480	0.460	Y



POLY CHAIN GT2 BELTS - 8MGT AND 14MGT

8MM PITCH - 36 MM WIDE					
Item description	Product Number	Teeth	Pitch Length (mm)	Weight (kg)	Stock
8MGT-640-36	9275-09019	80	640	0.106	Y
8MGT-720-36	9275-09027	90	720	0.120	Y
8MGT-800-36	9275-09035	100	800	0.140	Y
8MGT-896-36	9275-09043	112	896	0.160	Y
8MGT-960-36	9275-09047	120	960	0.173	Y
8MGT-1000-36	9275-09051	125	1000	0.180	Y
8MGT-1040-36	9275-09055	130	1040	0.187	Y
8MGT-1120-36	9275-09059	140	1120	0.200	Y
8MGT-1200-36	9275-09063	150	1200	0.200	Y
8MGT-1224-36	9275-09353	153	1224	0.220	Y
8MGT-1280-36	9275-09067	160	1280	0.230	Y
8MGT-1440-36	9275-09075	180	1440	0.260	Y
8MGT-1600-36	9275-09083	200	1600	0.280	Y
8MGT-1760-36	9275-09087	220	1760	0.317	Y
8MGT-1792-36	9275-09091	224	1792	0.320	Y
8MGT-2000-36	9275-09099	250	2000	0.360	Y
8MGT-2200-36	9275-09103	275	2200	0.396	Y
8MGT-2240-36	9275-09107	280	2240	0.390	Y
8MGT-2400-36	9275-09111	300	2400	0.420	Y
8MGT-2520-36	9275-09115	315	2520	0.440	Y
8MGT-2600-36	9275-09119	325	2600	0.468	Y
8MGT-2800-36	9275-09357	350	2800	0.504	Y
8MGT-2840-36	9275-09123	355	2840	0.500	Y
8MGT-3048-36	9275-09127	381	3048	0.549	Y
8MGT-3200-36	9275-09131	400	3200	0.580	Y
8MGT-3280-36	9275-09135	410	3280	0.590	Y
8MGT-3600-36	9275-09139	450	3600	0.640	Y
8MGT-4000-36	9275-09147	500	4000	0.710	Y
8MGT-4400-36	9275-09151	550	4400	0.792	Y
8MGT-4480-36	9275-09155	560	4480	0.790	Y

8MM PITCH - 62 MM WIDE					
Item description	Product Number	Teeth	Pitch Length (mm)	Weight (kg)	Stock
8MGT-640-62	9275-09020	80	640	0.200	Y
8MGT-720-62	9275-09028	90	720	0.220	Y
8MGT-800-62	9275-09036	100	800	0.240	Y
8MGT-896-62	9275-09044	112	896	0.270	Y
8MGT-960-62	9275-09048	120	960	0.298	Y
8MGT-1000-62	9275-09052	125	1000	0.300	Y
8MGT-1040-62	9275-09056	130	1040	0.322	Y
8MGT-1120-62	9275-09060	140	1120	0.340	Y
8MGT-1200-62	9275-09064	150	1200	0.340	Y
8MGT-1224-62	9275-09354	153	1224	0.379	Y
8MGT-1280-62	9275-09068	160	1280	0.390	Y
8MGT-1440-62	9275-09076	180	1440	0.432	Y
8MGT-1600-62	9275-09084	200	1600	0.490	Y
8MGT-1760-62	9275-09088	220	1760	0.546	Y
8MGT-1792-62	9275-09092	224	1792	0.550	Y
8MGT-2000-62	9275-09100	250	2000	0.610	Y
8MGT-2200-62	9275-09104	275	2200	0.682	Y
8MGT-2240-62	9275-09108	280	2240	0.680	Y
8MGT-2400-62	9275-09112	300	2400	0.730	Y
8MGT-2520-62	9275-09116	315	2520	0.770	Y
8MGT-2600-62	9275-09120	325	2600	0.806	Y
8MGT-2800-62	9275-09358	350	2800	0.868	Y
8MGT-2840-62	9275-09124	355	2840	0.870	Y
8MGT-3048-62	9275-09128	381	3048	0.945	Y
8MGT-3200-62	9275-09132	400	3200	0.980	Y
8MGT-3280-62	9275-09136	410	3280	1.017	Y
8MGT-3600-62	9275-09140	450	3600	1.100	Y
8MGT-4000-62	9275-09148	500	4000	1.220	Y
8MGT-4400-62	9275-09152	550	4400	1.364	Y
8MGT-4480-62	9275-09156	560	4480	1.370	Y

POLY CHAIN GT2



POLY CHAIN GT2 BELTS - 8MGT AND 14MGT

14MM PITCH - 20 MM WIDE						14MM PITCH - 37 MM WIDE					
Item description	Product Number	Teeth	Pitch Length (mm)	Weight (kg)	Stock	Item description	Product Number	Teeth	Pitch Length (mm)	Weight (kg)	Stock
14MGT-994-20	9275-09161	71	994	0.150	Y	14MGT-994-37	9275-09162	71	994	0.280	Y
14MGT-1120-20	9275-09169	80	1120	0.170	Y	14MGT-1120-37	9275-09170	80	1120	0.310	Y
14MGT-1190-20	9275-09173	85	1190	0.180	Y	14MGT-1190-37	9275-09174	85	1190	0.330	Y
14MGT-1260-20	9275-09177	90	1260	0.190	Y	14MGT-1260-37	9275-09178	90	1260	0.350	Y
14MGT-1400-20	9275-09185	100	1400	0.220	Y	14MGT-1400-37	9275-09186	100	1400	0.390	Y
14MGT-1568-20	9275-09193	112	1568	0.240	Y	14MGT-1568-37	9275-09194	112	1568	0.440	Y
14MGT-1610-20	9275-09197	115	1610	0.244	Y	14MGT-1610-37	9275-09198	115	1610	0.452	Y
14MGT-1750-20	9275-09201	125	1750	0.274	Y	14MGT-1750-37	9275-09202	125	1750	0.390	Y
14MGT-1890-20	9275-09205	135	1890	0.294	Y	14MGT-1890-37	9275-09206	135	1890	0.545	Y
14MGT-1960-20	9275-09209	140	1960	0.300	Y	14MGT-1960-37	9275-09210	140	1960	0.550	Y
14MGT-2100-20	9275-09213	150	2100	0.320	Y	14MGT-2100-37	9275-09214	150	2100	0.590	Y
14MGT-2240-20	9275-09217	160	2240	0.340	Y	14MGT-2240-37	9275-09218	160	2240	0.650	Y
14MGT-2310-20	9275-09359	165	2310	0.351	Y	14MGT-2310-37	9275-09360	165	2310	0.649	Y
14MGT-2380-20	9275-09221	170	2380	0.360	Y	14MGT-2380-37	9275-09222	170	2380	0.670	Y
14MGT-2450-20	9275-09363	175	2450	0.372	Y	14MGT-2450-37	9275-09364	175	2450	0.688	Y
14MGT-2520-20	9275-09225	180	2520	0.360	Y	14MGT-2520-37	9275-09226	180	2520	0.710	Y
14MGT-2590-20	9275-09367	185	2590	0.393	Y	14MGT-2590-37	9275-09368	185	2590	0.727	Y
14MGT-2660-20	9275-09229	190	2660	0.400	Y	14MGT-2660-37	9275-09230	190	2660	0.750	Y
14MGT-2800-20	9275-09233	200	2800	0.430	Y	14MGT-2800-37	9275-09234	200	2800	0.780	Y
14MGT-3136-20	9275-09241	224	3136	0.480	Y	14MGT-3136-37	9275-09242	224	3136	0.880	Y
14MGT-3304-20	9275-09245	236	3304	0.500	Y	14MGT-3304-37	9275-09246	236	3304	0.930	Y
14MGT-3360-20	9275-09371	240	3360	0.510	Y	14MGT-3360-37	9275-09372	240	3360	0.944	Y
14MGT-3500-20	9275-09249	250	3500	0.540	Y	14MGT-3500-37	9275-09250	250	3500	0.980	Y
14MGT-3850-20	9275-09253	275	3850	0.585	Y	14MGT-3850-37	9275-09254	275	3850	1.081	Y
14MGT-3920-20	9275-09257	280	3920	0.600	Y	14MGT-3920-37	9275-09258	280	3920	1.100	Y
14MGT-4326-20	9275-09261	309	4326	0.657	Y	14MGT-4326-37	9275-09262	309	4326	1.215	Y
14MGT-4410-20	9275-09265	315	4410	0.670	Y	14MGT-4410-37	9275-09266	315	4410	1.240	Y



POLY CHAIN GT2 BELTS - 8MGT AND 14MGT

14MM PITCH - 68 MM WIDE					
Item description	Product Number	Teeth	Pitch Length (mm)	Weight (kg)	Stock
14MGT-994-68	9275-09163	71	994	0.510	Y
14MGT-1120-68	9275-09171	80	1120	0.580	Y
14MGT-1190-68	9275-09175	85	1190	0.610	Y
14MGT-1260-68	9275-09179	90	1260	0.650	Y
14MGT-1400-68	9275-09187	100	1400	0.720	Y
14MGT-1568-68	9275-09195	112	1568	0.810	Y
14MGT-1610-68	9275-09199	115	1610	0.831	Y
14MGT-1750-68	9275-09203	125	1750	0.931	Y
14MGT-1890-68	9275-09207	135	1890	1.005	Y
14MGT-1960-68	9275-09211	140	1960	1.010	Y
14MGT-2100-68	9275-09215	150	2100	1.080	Y
14MGT-2240-68	9275-09219	160	2240	1.160	Y
14MGT-2310-68	9275-09361	165	2310	1.192	Y
14MGT-2380-68	9275-09223	170	2380	1.230	Y
14MGT-2450-68	9275-09365	175	2450	1.265	Y
14MGT-2520-68	9275-09227	180	2520	1.300	Y
14MGT-2590-68	9275-09369	185	2590	1.337	Y
14MGT-2660-68	9275-09231	190	2660	1.370	Y
14MGT-2800-68	9275-09235	200	2800	1.450	Y
14MGT-3136-68	9275-09243	224	3136	1.620	Y
14MGT-3304-68	9275-09247	236	3304	1.710	Y
14MGT-3360-68	9275-09373	240	3360	1.734	Y
14MGT-3500-68	9275-09251	250	3500	1.810	Y
14MGT-3850-68	9275-09255	275	3850	1.987	Y
14MGT-3920-68	9275-09259	280	3920	2.020	Y
14MGT-4326-68	9275-09263	309	4326	2.233	Y
14MGT-4410-68	9275-09267	315	4410	2.280	Y

14MM PITCH - 90 MM WIDE					
Item description	Product Number	Teeth	Pitch Length (mm)	Weight (kg)	Stock
14MGT-994-90	9275-09305	71	994	0.695	Y
14MGT-1120-90	9275-09307	80	1120	0.800	Y
14MGT-1190-90	9275-09308	85	1190	0.850	Y
14MGT-1260-90	9275-09309	90	1260	0.905	Y
14MGT-1400-90	9275-09311	100	1400	0.980	Y
14MGT-1568-90	9275-09313	112	1568	1.125	Y
14MGT-1610-90	9275-09314	115	1610	1.100	Y
14MGT-1750-90	9275-09315	125	1750	1.195	Y
14MGT-1890-90	9275-09316	135	1890	1.330	Y
14MGT-1960-90	9275-09317	140	1960	1.375	Y
14MGT-2100-90	9275-09318	150	2100	1.495	Y
14MGT-2240-90	9275-09319	160	2240	1.615	Y
14MGT-2310-90	9275-09335	165	2310	1.578	Y
14MGT-2380-90	9275-09320	170	2380	1.695	Y
14MGT-2450-90	9275-09336	175	2450	1.674	Y
14MGT-2520-90	9275-09321	180	2520	1.780	Y
14MGT-2590-90	9275-09337	185	2590	1.769	Y
14MGT-2660-90	9275-09322	190	2660	1.880	Y
14MGT-2800-90	9275-09323	200	2800	1.935	Y
14MGT-3136-90	9275-09325	224	3136	2.240	Y
14MGT-3304-90	9275-09326	236	3304	2.355	Y
14MGT-3360-90	9275-09338	240	3360	2.296	Y
14MGT-3500-90	9275-09327	250	3500	2.810	Y
14MGT-3850-90	9275-09328	275	3850	2.630	Y
14MGT-3920-90	9275-09329	280	3920	2.840	Y
14MGT-4326-90	9275-09330	309	4326	2.955	Y
14MGT-4410-90	9275-09331	315	4410	3.115	Y

POLY CHAIN GT2



POLY CHAIN GT2 BELTS - 8MGT AND 14MGT

14MM PITCH - 125 MM WIDE					
Item description	Product Number	Teeth	Pitch Length (mm)	Weight (kg)	Stock
14MGT-994-125	9275-09164	71	994	0.940	Y
14MGT-1120-125	9275-09172	80	1120	1.060	Y
14MGT-1190-125	9275-09176	85	1190	1.130	Y
14MGT-1260-125	9275-09180	90	1260	1.200	Y
14MGT-1400-125	9275-09188	100	1400	1.530	Y
14MGT-1568-125	9275-09196	112	1568	1.490	Y
14MGT-1610-125	9275-09200	115	1610	1.528	Y
14MGT-1750-125	9275-09204	125	1750	1.530	Y
14MGT-1890-125	9275-09208	135	1890	1.847	Y
14MGT-1960-125	9275-09212	140	1960	1.860	Y
14MGT-2100-125	9275-09216	150	2100	1.990	Y
14MGT-2240-125	9275-09220	160	2240	2.130	Y
14MGT-2310-125	9275-09362	165	2310	2.192	Y
14MGT-2380-125	9275-09224	170	2380	2.260	Y
14MGT-2450-125	9275-09366	175	2450	2.325	Y
14MGT-2520-125	9275-09228	180	2520	2.390	Y
14MGT-2590-125	9275-09370	185	2590	2.458	Y
14MGT-2660-125	9275-09232	190	2660	2.530	Y
14MGT-2800-125	9275-09236	200	2800	2.660	Y
14MGT-3136-125	9275-09244	224	3136	2.980	Y
14MGT-3304-125	9275-09248	236	3304	3.130	Y
14MGT-3360-125	9275-09374	240	3360	3.188	Y
14MGT-3500-125	9275-09252	250	3500	3.320	Y
14MGT-3850-125	9275-09256	275	3850	3.653	Y
14MGT-3920-125	9275-09260	280	3920	3.720	Y
14MGT-4326-125	9275-09264	309	4326	4.105	Y
14MGT-4410-125	9275-09268	315	4410	4.190	Y



POWERGRIP GTX BELTS AND SLABS - 8MX AND 14MX

Recommended Sprockets

PowerGrip HTD and/or GT Sprockets

NOTES: 8M and 14M PowerGrip GTX belts are static conductive in accordance with ISO 9653 and for conditions described in the Directive 2014/34/EU-ATEX. Belt pitch is the distance in millimeters between two adjacent tooth centers as measured on the pitch line of the belt. Belt pitch length is the total length (circumference) in millimeters as measured along the pitch line. The theoretical pitch line of a PowerGrip GTX belt lies within the tensile member. PowerGrip GT4 part numbers are comprised of pitch length, pitch, and width. For example, part number 3150-14MX-55 denotes a 3150mm pitch length, 14mm pitch, and 55mm width. Synchronous pitch length is always a multiple of the belt pitch.

Item description build up: length-pitch-width

8MM PITCH - 20 MM WIDE						
Item description	Product Number	Teeth	Pitch Length (mm)	Weight (kg)	Stock	Tooth profile
264-8MX-20	9327-50000	33	264	0.036	N	HTD
320-8MX-20	9327-50007	40	320	0.043	N	HTD
376-8MX-20	9327-50015	47	376	0.050	Y	HTD
384-8MX-20	9327-50023	48	384	0.046	Y	GT
424-8MX-20	9327-50031	53	424	0.050	Y	GT
472-8MX-20	9327-50651	59	472	0.056	Y	GT
480-8MX-20	9327-50039	60	480	0.057	Y	HTD
512-8MX-20	9327-50047	64	512	0.067	Y	HTD
520-8MX-20	9327-50055	65	520	0.068	Y	HTD
560-8MX-20	9327-50063	70	560	0.066	Y	HTD
576-8MX-20	9327-50071	72	576	0.075	Y	HTD
600-8MX-20	9327-50079	75	600	0.070	Y	GT
608-8MX-20	9327-50087	76	608	0.079	Y	HTD
624-8MX-20	9327-50095	78	624	0.081	Y	HTD
640-8MX-20	9327-50103	80	640	0.075	Y	HTD
656-8MX-20	9327-50111	82	656	0.077	Y	GT
720-8MX-20	9327-50119	90	720	0.084	Y	HTD
760-8MX-20	9327-50127	95	760	0.098	Y	GT
776-8MX-20	9327-50135	97	776	0.089	Y	HTD
800-8MX-20	9327-50143	100	800	0.095	Y	GT
840-8MX-20	9327-50158	105	840	0.097	Y	GT
856-8MX-20	9327-50150	107	856	0.110	N	HTD
880-8MX-20	9327-50166	110	880	0.092	Y	GT
912-8MX-20	9327-50174	114	912	0.123	Y	HTD
920-8MX-20	9327-50182	115	920	0.105	Y	GT
960-8MX-20	9327-50190	120	960	0.113	Y	GT
968-8MX-20	9327-50198	121	968	0.122	Y	HTD
976-8MX-20	9327-50206	122	976	0.102	Y	GT
1000-8MX-20	9327-50214	125	1000	0.115	Y	GT
1040-8MX-20	9327-50222	130	1040	0.122	Y	HTD
1064-8MX-20	9327-50230	133	1064	0.135	Y	HTD
1080-8MX-20	9327-50238	135	1080	0.137	Y	GT
1120-8MX-20	9327-50246	140	1120	0.131	Y	GT
1128-8MX-20	9327-50254	141	1128	0.141	Y	HTD
1160-8MX-20	9327-50262	145	1160	0.138	Y	HTD
1176-8MX-20	9327-50269	147	1176	0.160	N	HTD

8MM PITCH - 20 MM WIDE						
Item description	Product Number	Teeth	Pitch Length (mm)	Weight (kg)	Stock	Tooth profile
1200-8MX-20	9327-50277	150	1200	0.141	Y	GT
1216-8MX-20	9327-50285	152	1216	0.155	Y	HTD
1224-8MX-20	9327-50293	153	1224	0.139	Y	HTD
1256-8MX-20	9327-50301	157	1256	0.144	Y	HTD
1264-8MX-20	9327-50309	158	1264	0.160	Y	HTD
1280-8MX-20	9327-50317	160	1280	0.150	Y	GT
1304-8MX-20	9327-50325	163	1304	0.150	Y	HTD
1360-8MX-20	9327-50333	170	1360	0.161	Y	HTD
1424-8MX-20	9327-50341	178	1424	0.169	Y	HTD
1432-8MX-20	9327-50348	179	1432	0.178	N	HTD
1440-8MX-20	9327-50356	180	1440	0.169	Y	GT
1512-8MX-20	9327-50364	189	1512	0.191	Y	GT
1520-8MX-20	9327-50372	190	1520	0.192	Y	HTD
1552-8MX-20	9327-50380	194	1552	0.196	Y	HTD
1584-8MX-20	9327-50388	198	1584	0.200	Y	GT
1600-8MX-20	9327-50396	200	1600	0.187	Y	GT
1696-8MX-20	9327-50404	212	1696	0.214	Y	HTD
1728-8MX-20	9327-50411	216	1728	0.201	N	HTD
1760-8MX-20	9327-50419	220	1760	0.202	Y	GT
1800-8MX-20	9327-50427	225	1800	0.212	Y	GT
1880-8MX-20	9327-50434	235	1880	0.241	N	HTD
1896-8MX-20	9327-50442	237	1896	0.239	Y	HTD
1904-8MX-20	9327-50450	238	1904	0.240	Y	HTD
2000-8MX-20	9327-50458	250	2000	0.231	Y	HTD
2080-8MX-20	9327-50466	260	2080	0.289	Y	HTD
2200-8MX-20	9327-50473	275	2200	0.277	N	HTD
2240-8MX-20	9327-50481	280	2240	0.335	Y	HTD
2272-8MX-20	9327-50489	284	2272	0.353	Y	HTD
2400-8MX-20	9327-50497	300	2400	0.352	Y	HTD
2504-8MX-20	9327-50504	313	2504	0.316	N	HTD
2600-8MX-20	9327-50512	325	2600	0.366	Y	HTD
2800-8MX-20	9327-50520	350	2800	0.410	Y	HTD
3048-8MX-20	9327-50528	381	3048	0.351	Y	GT
3280-8MX-20	9327-50536	410	3280	0.378	Y	GT
3600-8MX-20	9327-50544	450	3600	0.415	Y	GT
4400-8MX-20	9327-50552	550	4400	0.507	Y	GT

POWERGRIP GTX

POWERGRIP GTX BELTS AND SLABS - 8MX AND 14MX

8MM PITCH - 30 MM WIDE						
Item description	Product Number	Teeth	Pitch Length (mm)	Weight (kg)	Stock	Tooth profile
264-8MX-30	9327-50001	33	264	0.054	N	HTD
320-8MX-30	9327-50008	40	320	0.065	N	HTD
376-8MX-30	9327-50016	47	376	0.075	Y	HTD
384-8MX-30	9327-50024	48	384	0.071	Y	GT
424-8MX-30	9327-50032	53	424	0.078	Y	GT
472-8MX-30	9327-50652	59	472	0.087	Y	GT
480-8MX-30	9327-50040	60	480	0.084	Y	HTD
512-8MX-30	9327-50048	64	512	0.093	Y	HTD
520-8MX-30	9327-50056	65	520	0.102	Y	HTD
560-8MX-30	9327-50064	70	560	0.102	Y	HTD
576-8MX-30	9327-50072	72	576	0.113	Y	HTD
600-8MX-30	9327-50080	75	600	0.109	Y	GT
608-8MX-30	9327-50088	76	608	0.119	Y	HTD
624-8MX-30	9327-50096	78	624	0.122	Y	HTD
640-8MX-30	9327-50104	80	640	0.116	Y	HTD
656-8MX-30	9327-50112	82	656	0.118	Y	GT
720-8MX-30	9327-50120	90	720	0.124	Y	HTD
760-8MX-30	9327-50128	95	760	0.147	Y	GT
776-8MX-30	9327-50136	97	776	0.140	Y	HTD
800-8MX-30	9327-50144	100	800	0.146	Y	GT
840-8MX-30	9327-50159	105	840	0.145	Y	GT
856-8MX-30	9327-50151	107	856	0.165	N	HTD
880-8MX-30	9327-50167	110	880	0.158	Y	GT
912-8MX-30	9327-50175	114	912	0.166	Y	HTD
920-8MX-30	9327-50183	115	920	0.176	Y	GT
960-8MX-30	9327-50191	120	960	0.174	Y	GT
968-8MX-30	9327-50199	121	968	0.170	Y	HTD
976-8MX-30	9327-50207	122	976	0.187	Y	GT
1000-8MX-30	9327-50215	125	1000	0.178	Y	GT
1040-8MX-30	9327-50223	130	1040	0.189	Y	HTD
1064-8MX-30	9327-50231	133	1064	0.203	Y	HTD
1080-8MX-30	9327-50239	135	1080	0.206	Y	GT
1120-8MX-30	9327-50247	140	1120	0.203	Y	GT
1128-8MX-30	9327-50255	141	1128	0.213	Y	HTD
1160-8MX-30	9327-50263	145	1160	0.207	Y	HTD
1176-8MX-30	9327-50270	147	1176	0.224	N	HTD
1200-8MX-30	9327-50278	150	1200	0.217	Y	GT
1216-8MX-30	9327-50286	152	1216	0.221	Y	HTD
1224-8MX-30	9327-50294	153	1224	0.217	Y	HTD
1256-8MX-30	9327-50302	157	1256	0.297	Y	HTD
1264-8MX-30	9327-50310	158	1264	0.270	Y	HTD
1280-8MX-30	9327-50318	160	1280	0.226	Y	GT
1304-8MX-30	9327-50326	163	1304	0.231	Y	HTD
1360-8MX-30	9327-50334	170	1360	0.242	Y	HTD

8MM PITCH - 30 MM WIDE						
Item description	Product Number	Teeth	Pitch Length (mm)	Weight (kg)	Stock	Tooth profile
1424-8MX-30	9327-50342	178	1424	0.253	Y	HTD
1432-8MX-30	9327-50349	179	1432	0.229	N	HTD
1440-8MX-30	9327-50357	180	1440	0.253	Y	GT
1512-8MX-30	9327-50365	189	1512	0.272	Y	GT
1520-8MX-30	9327-50373	190	1520	0.288	Y	HTD
1552-8MX-30	9327-50381	194	1552	0.294	Y	HTD
1584-8MX-30	9327-50389	198	1584	0.285	Y	GT
1600-8MX-30	9327-50397	200	1600	0.281	Y	GT
1696-8MX-30	9327-50405	212	1696	0.321	Y	HTD
1728-8MX-30	9327-50412	216	1728	0.327	N	HTD
1760-8MX-30	9327-50420	220	1760	0.303	Y	GT
1800-8MX-30	9327-50428	225	1800	0.319	Y	GT
1880-8MX-30	9327-50435	235	1880	0.152	N	HTD
1896-8MX-30	9327-50443	237	1896	0.359	Y	HTD
1904-8MX-30	9327-50451	238	1904	0.360	Y	HTD
2000-8MX-30	9327-50459	250	2000	0.361	Y	HTD
2080-8MX-30	9327-50467	260	2080	0.481	Y	HTD
2200-8MX-30	9327-50474	275	2200	0.416	N	HTD
2240-8MX-30	9327-50482	280	2240	0.493	Y	HTD
2272-8MX-30	9327-50490	284	2272	0.500	Y	HTD
2400-8MX-30	9327-50498	300	2400	0.528	Y	HTD
2504-8MX-30	9327-50505	313	2504	0.473	N	HTD
2600-8MX-30	9327-50513	325	2600	0.549	Y	HTD
2800-8MX-30	9327-50521	350	2800	0.615	Y	HTD
3048-8MX-30	9327-50529	381	3048	0.527	Y	GT
3280-8MX-30	9327-50537	410	3280	0.567	Y	GT
3600-8MX-30	9327-50545	450	3600	0.622	Y	GT
4400-8MX-30	9327-50553	550	4400	0.760	Y	GT



POWERGRIP GTX BELTS AND SLABS - 8MX AND 14MX

8MM PITCH - 40 MM WIDE						
Item description	Product Number	Teeth	Pitch Length (mm)	Weight (kg)	Stock	Tooth profile
264-8MX-40	9327-50002	33	264	0.072	N	HTD
320-8MX-40	9327-50009	40	320	0.087	N	HTD
376-8MX-40	9327-50017	47	376	0.100	Y	HTD
384-8MX-40	9327-50025	48	384	0.095	Y	GT
424-8MX-40	9327-50033	53	424	0.104	Y	GT
472-8MX-40	9327-50653	59	472	0.116	Y	GT
480-8MX-40	9327-50041	60	480	0.112	Y	HTD
512-8MX-40	9327-50049	64	512	0.124	Y	HTD
520-8MX-40	9327-50057	65	520	0.136	Y	HTD
560-8MX-40	9327-50065	70	560	0.136	Y	HTD
576-8MX-40	9327-50073	72	576	0.151	Y	HTD
600-8MX-40	9327-50081	75	600	0.145	Y	GT
608-8MX-40	9327-50089	76	608	0.159	Y	HTD
624-8MX-40	9327-50097	78	624	0.163	Y	HTD
640-8MX-40	9327-50105	80	640	0.155	Y	HTD
656-8MX-40	9327-50113	82	656	0.157	Y	GT
720-8MX-40	9327-50121	90	720	0.165	Y	HTD
760-8MX-40	9327-50129	95	760	0.196	Y	GT
776-8MX-40	9327-50137	97	776	0.187	Y	HTD
800-8MX-40	9327-50145	100	800	0.195	Y	GT
840-8MX-40	9327-50160	105	840	0.193	Y	GT
856-8MX-40	9327-50152	107	856	0.220	N	HTD
880-8MX-40	9327-50168	110	880	0.184	Y	GT
912-8MX-40	9327-50176	114	912	0.221	Y	HTD
920-8MX-40	9327-50184	115	920	0.235	Y	GT
960-8MX-40	9327-50192	120	960	0.232	Y	GT
968-8MX-40	9327-50200	121	968	0.227	Y	HTD
976-8MX-40	9327-50208	122	976	0.249	Y	GT
1000-8MX-40	9327-50216	125	1000	0.237	Y	GT
1040-8MX-40	9327-50224	130	1040	0.252	Y	HTD
1064-8MX-40	9327-50232	133	1064	0.271	Y	HTD
1080-8MX-40	9327-50240	135	1080	0.275	Y	GT
1120-8MX-40	9327-50248	140	1120	0.271	Y	GT
1128-8MX-40	9327-50256	141	1128	0.284	Y	HTD
1160-8MX-40	9327-50264	145	1160	0.276	Y	HTD
1176-8MX-40	9327-50271	147	1176	0.299	N	HTD
1200-8MX-40	9327-50279	150	1200	0.289	Y	GT
1216-8MX-40	9327-50287	152	1216	0.295	Y	HTD
1224-8MX-40	9327-50295	153	1224	0.289	Y	HTD
1256-8MX-40	9327-50303	157	1256	0.396	Y	HTD
1264-8MX-40	9327-50311	158	1264	0.360	Y	HTD
1280-8MX-40	9327-50319	160	1280	0.301	Y	GT
1304-8MX-40	9327-50327	163	1304	0.308	Y	HTD
1360-8MX-40	9327-50335	170	1360	0.323	Y	HTD

8MM PITCH - 40 MM WIDE						
Item description	Product Number	Teeth	Pitch Length (mm)	Weight (kg)	Stock	Tooth profile
1424-8MX-40	9327-50343	178	1424	0.337	Y	HTD
1432-8MX-40	9327-50350	179	1432	0.305	N	HTD
1440-8MX-40	9327-50358	180	1440	0.337	Y	GT
1512-8MX-40	9327-50366	189	1512	0.363	Y	GT
1520-8MX-40	9327-50374	190	1520	0.384	Y	HTD
1552-8MX-40	9327-50382	194	1552	0.392	Y	HTD
1584-8MX-40	9327-50390	198	1584	0.380	Y	GT
1600-8MX-40	9327-50398	200	1600	0.375	Y	GT
1696-8MX-40	9327-50406	212	1696	0.428	Y	HTD
1728-8MX-40	9327-50413	216	1728	0.436	N	HTD
1760-8MX-40	9327-50421	220	1760	0.404	Y	GT
1800-8MX-40	9327-50429	225	1800	0.425	Y	GT
1880-8MX-40	9327-50436	235	1880	0.481	N	HTD
1896-8MX-40	9327-50444	237	1896	0.479	Y	HTD
1904-8MX-40	9327-50452	238	1904	0.480	Y	HTD
2000-8MX-40	9327-50460	250	2000	0.481	Y	HTD
2080-8MX-40	9327-50468	260	2080	0.533	Y	HTD
2200-8MX-40	9327-50475	275	2200	0.555	N	HTD
2240-8MX-40	9327-50483	280	2240	0.657	Y	HTD
2272-8MX-40	9327-50491	284	2272	0.667	Y	HTD
2400-8MX-40	9327-50499	300	2400	0.704	Y	HTD
2504-8MX-40	9327-50506	313	2504	0.631	N	HTD
2600-8MX-40	9327-50514	325	2600	0.732	Y	HTD
2800-8MX-40	9327-50522	350	2800	0.717	Y	HTD
3048-8MX-40	9327-50530	381	3048	0.703	Y	GT
3280-8MX-40	9327-50538	410	3280	0.756	Y	GT
3600-8MX-40	9327-50546	450	3600	0.829	Y	GT
4400-8MX-40	9327-50554	550	4400	1.013	Y	GT

POWERGRIP GTX



POWERGRIP GTX BELTS AND SLABS - 8MX AND 14MX

8MM PITCH - 50 MM WIDE						
Item description	Product Number	Teeth	Pitch Length (mm)	Weight (kg)	Stock	Tooth profile
264-8MX-50	9327-50003	33	264	0.091	N	HTD
320-8MX-50	9327-50010	40	320	0.108	N	HTD
376-8MX-50	9327-50018	47	376	0.141	Y	HTD
384-8MX-50	9327-50026	48	384	0.122	Y	GT
424-8MX-50	9327-50034	53	424	0.125	Y	GT
472-8MX-50	9327-50654	59	472	0.139	Y	GT
480-8MX-50	9327-50042	60	480	0.151	Y	HTD
512-8MX-50	9327-50050	64	512	0.160	Y	HTD
520-8MX-50	9327-50058	65	520	0.170	Y	HTD
560-8MX-50	9327-50066	70	560	0.175	Y	HTD
576-8MX-50	9327-50074	72	576	0.188	Y	HTD
600-8MX-50	9327-50082	75	600	0.186	Y	GT
608-8MX-50	9327-50090	76	608	0.198	Y	HTD
624-8MX-50	9327-50098	78	624	0.203	Y	HTD
640-8MX-50	9327-50106	80	640	0.198	Y	HTD
656-8MX-50	9327-50114	82	656	0.203	Y	GT
720-8MX-50	9327-50122	90	720	0.207	Y	HTD
760-8MX-50	9327-50130	95	760	0.244	Y	GT
776-8MX-50	9327-50138	97	776	0.249	Y	HTD
800-8MX-50	9327-50146	100	800	0.251	Y	GT
840-8MX-50	9327-50161	105	840	0.242	Y	GT
856-8MX-50	9327-50153	107	856	0.294	N	HTD
880-8MX-50	9327-50169	110	880	0.232	Y	GT
912-8MX-50	9327-50177	114	912	0.251	Y	HTD
920-8MX-50	9327-50185	115	920	0.294	Y	GT
960-8MX-50	9327-50193	120	960	0.299	Y	GT
968-8MX-50	9327-50201	121	968	0.305	Y	HTD
976-8MX-50	9327-50209	122	976	0.311	Y	GT
1000-8MX-50	9327-50217	125	1000	0.306	Y	GT
1040-8MX-50	9327-50225	130	1040	0.324	Y	HTD
1064-8MX-50	9327-50233	133	1064	0.339	Y	HTD
1080-8MX-50	9327-50241	135	1080	0.344	Y	GT
1120-8MX-50	9327-50249	140	1120	0.348	Y	GT
1128-8MX-50	9327-50257	141	1128	0.359	Y	HTD
1160-8MX-50	9327-50265	145	1160	0.369	Y	HTD
1176-8MX-50	9327-50272	147	1176	0.401	N	HTD
1200-8MX-50	9327-50280	150	1200	0.372	Y	GT
1216-8MX-50	9327-50288	152	1216	0.354	Y	HTD
1224-8MX-50	9327-50296	153	1224	0.335	Y	HTD
1256-8MX-50	9327-50304	157	1256	0.382	Y	HTD
1264-8MX-50	9327-50312	158	1264	0.401	Y	HTD
1280-8MX-50	9327-50320	160	1280	0.380	Y	GT
1304-8MX-50	9327-50328	163	1304	0.396	Y	HTD
1360-8MX-50	9327-50336	170	1360	0.431	Y	HTD

8MM PITCH - 50 MM WIDE						
Item description	Product Number	Teeth	Pitch Length (mm)	Weight (kg)	Stock	Tooth profile
1424-8MX-50	9327-50344	178	1424	0.450	Y	HTD
1432-8MX-50	9327-50351	179	1432	0.446	N	HTD
1440-8MX-50	9327-50359	180	1440	0.427	Y	GT
1512-8MX-50	9327-50367	189	1512	0.480	Y	GT
1520-8MX-50	9327-50375	190	1520	0.480	Y	HTD
1552-8MX-50	9327-50383	194	1552	0.490	Y	HTD
1584-8MX-50	9327-50391	198	1584	0.499	Y	GT
1600-8MX-50	9327-50399	200	1600	0.473	Y	GT
1696-8MX-50	9327-50407	212	1696	0.536	Y	HTD
1728-8MX-50	9327-50414	216	1728	0.544	N	HTD
1760-8MX-50	9327-50422	220	1760	0.459	Y	GT
1800-8MX-50	9327-50430	225	1800	0.567	Y	GT
1880-8MX-50	9327-50437	235	1880	0.602	N	HTD
1896-8MX-50	9327-50445	237	1896	0.598	Y	HTD
1904-8MX-50	9327-50453	238	1904	0.600	Y	HTD
2000-8MX-50	9327-50461	250	2000	0.641	Y	HTD
2080-8MX-50	9327-50469	260	2080	0.666	Y	HTD
2200-8MX-50	9327-50476	275	2200	0.693	N	HTD
2240-8MX-50	9327-50484	280	2240	0.717	Y	HTD
2272-8MX-50	9327-50492	284	2272	0.727	Y	HTD
2400-8MX-50	9327-50500	300	2400	0.768	Y	HTD
2504-8MX-50	9327-50507	313	2504	0.789	N	HTD
2600-8MX-50	9327-50515	325	2600	0.832	Y	HTD
2800-8MX-50	9327-50523	350	2800	0.896	Y	HTD
3048-8MX-50	9327-50531	381	3048	0.878	Y	GT
3280-8MX-50	9327-50539	410	3280	0.945	Y	GT
3600-8MX-50	9327-50547	450	3600	1.037	Y	GT
4400-8MX-50	9327-50555	550	4400	1.267	Y	GT

POWERGRIP GTX



POWERGRIP GTX BELTS AND SLABS - 8MX AND 14MX

8MM PITCH - 65 MM WIDE						
Item description	Product Number	Teeth	Pitch Length (mm)	Weight (kg)	Stock	Tooth profile
264-8MX-65	9327-50004	33	264	0.118	N	HTD
320-8MX-65	9327-50011	40	320	0.140	N	HTD
376-8MX-65	9327-50019	47	376	0.183	Y	HTD
384-8MX-65	9327-50027	48	384	0.159	Y	GT
424-8MX-65	9327-50035	53	424	0.163	Y	GT
472-8MX-65	9327-50655	59	472	0.181	Y	GT
480-8MX-65	9327-50043	60	480	0.196	Y	HTD
512-8MX-65	9327-50051	64	512	0.208	Y	HTD
520-8MX-65	9327-50059	65	520	0.221	Y	HTD
560-8MX-65	9327-50067	70	560	0.228	Y	HTD
576-8MX-65	9327-50075	72	576	0.244	Y	HTD
600-8MX-65	9327-50083	75	600	0.242	Y	GT
608-8MX-65	9327-50091	76	608	0.257	Y	HTD
624-8MX-65	9327-50099	78	624	0.264	Y	HTD
640-8MX-65	9327-50107	80	640	0.257	Y	HTD
656-8MX-65	9327-50115	82	656	0.264	Y	GT
720-8MX-65	9327-50123	90	720	0.269	Y	HTD
760-8MX-65	9327-50131	95	760	0.317	Y	GT
776-8MX-65	9327-50139	97	776	0.324	Y	HTD
800-8MX-65	9327-50147	100	800	0.326	Y	GT
840-8MX-65	9327-50162	105	840	0.315	Y	GT
856-8MX-65	9327-50154	107	856	0.382	N	HTD
880-8MX-65	9327-50170	110	880	0.302	Y	GT
912-8MX-65	9327-50178	114	912	0.326	Y	HTD
920-8MX-65	9327-50186	115	920	0.382	Y	GT
960-8MX-65	9327-50194	120	960	0.389	Y	GT
968-8MX-65	9327-50202	121	968	0.397	Y	HTD
976-8MX-65	9327-50210	122	976	0.404	Y	GT
1000-8MX-65	9327-50218	125	1000	0.398	Y	GT
1040-8MX-65	9327-50226	130	1040	0.421	Y	HTD
1064-8MX-65	9327-50234	133	1064	0.441	Y	HTD
1080-8MX-65	9327-50242	135	1080	0.447	Y	GT
1120-8MX-65	9327-50250	140	1120	0.452	Y	GT
1128-8MX-65	9327-50258	141	1128	0.467	Y	HTD
1160-8MX-65	9327-50266	145	1160	0.480	Y	HTD
1176-8MX-65	9327-50273	147	1176	0.521	N	HTD
1200-8MX-65	9327-50281	150	1200	0.484	Y	GT
1216-8MX-65	9327-50289	152	1216	0.460	Y	HTD
1224-8MX-65	9327-50297	153	1224	0.436	Y	HTD
1256-8MX-65	9327-50305	157	1256	0.497	Y	HTD
1264-8MX-65	9327-50313	158	1264	0.521	Y	HTD
1280-8MX-65	9327-50321	160	1280	0.494	Y	GT
1304-8MX-65	9327-50329	163	1304	0.515	Y	HTD
1360-8MX-65	9327-50337	170	1360	0.560	Y	HTD

8MM PITCH - 65 MM WIDE						
Item description	Product Number	Teeth	Pitch Length (mm)	Weight (kg)	Stock	Tooth profile
1424-8MX-65	9327-50345	178	1424	0.585	Y	HTD
1432-8MX-65	9327-50352	179	1432	0.184	N	HTD
1440-8MX-65	9327-50360	180	1440	0.555	Y	GT
1512-8MX-65	9327-50368	189	1512	0.624	Y	GT
1520-8MX-65	9327-50376	190	1520	0.624	Y	HTD
1552-8MX-65	9327-50384	194	1552	0.637	Y	HTD
1584-8MX-65	9327-50392	198	1584	0.649	Y	GT
1600-8MX-65	9327-50400	200	1600	0.615	Y	GT
1696-8MX-65	9327-50408	212	1696	0.697	Y	HTD
1728-8MX-65	9327-50415	216	1728	0.707	N	HTD
1760-8MX-65	9327-50423	220	1760	0.687	Y	GT
1800-8MX-65	9327-50431	225	1800	0.737	Y	GT
1880-8MX-65	9327-50438	235	1880	0.329	N	HTD
1896-8MX-65	9327-50446	237	1896	0.777	Y	HTD
1904-8MX-65	9327-50454	238	1904	0.780	Y	HTD
2000-8MX-65	9327-50462	250	2000	0.833	Y	HTD
2080-8MX-65	9327-50470	260	2080	0.865	Y	HTD
2200-8MX-65	9327-50477	275	2200	0.901	N	HTD
2240-8MX-65	9327-50485	280	2240	0.932	Y	HTD
2272-8MX-65	9327-50493	284	2272	0.945	Y	HTD
2400-8MX-65	9327-50501	300	2400	0.998	Y	HTD
2504-8MX-65	9327-50508	313	2504	1.026	N	HTD
2600-8MX-65	9327-50516	325	2600	1.081	Y	HTD
2800-8MX-65	9327-50524	350	2800	1.165	Y	HTD
3048-8MX-65	9327-50532	381	3048	1.141	Y	GT
3280-8MX-65	9327-50540	410	3280	1.229	Y	GT
3600-8MX-65	9327-50548	450	3600	1.348	Y	GT
4400-8MX-65	9327-50556	550	4400	1.647	Y	GT

POWERGRIP GTX

POWERGRIP GTX BELTS AND SLABS - 8MX AND 14MX

8MM PITCH - 85 MM WIDE						
Item description	Product Number	Teeth	Pitch Length (mm)	Weight (kg)	Stock	Tooth profile
264-8MX-85	9327-50005	33	264	0.154	N	HTD
320-8MX-85	9327-50012	40	320	0.184	N	HTD
376-8MX-85	9327-50020	47	376	0.213	Y	HTD
384-8MX-85	9327-50028	48	384	0.207	Y	GT
424-8MX-85	9327-50036	53	424	0.209	Y	GT
472-8MX-85	9327-50656	59	472	0.233	Y	GT
480-8MX-85	9327-50044	60	480	0.264	Y	HTD
512-8MX-85	9327-50052	64	512	0.281	Y	HTD
520-8MX-85	9327-50060	65	520	0.290	Y	HTD
560-8MX-85	9327-50068	70	560	0.306	Y	HTD
576-8MX-85	9327-50076	72	576	0.319	Y	HTD
600-8MX-85	9327-50084	75	600	0.327	Y	GT
608-8MX-85	9327-50092	76	608	0.336	Y	HTD
624-8MX-85	9327-50100	78	624	0.344	Y	HTD
640-8MX-85	9327-50108	80	640	0.347	Y	HTD
656-8MX-85	9327-50116	82	656	0.318	Y	GT
720-8MX-85	9327-50124	90	720	0.389	Y	HTD
760-8MX-85	9327-50132	95	760	0.411	Y	GT
776-8MX-85	9327-50140	97	776	0.449	Y	HTD
800-8MX-85	9327-50148	100	800	0.439	Y	GT
840-8MX-85	9327-50163	105	840	0.411	Y	GT
856-8MX-85	9327-50155	107	856	0.500	N	HTD
880-8MX-85	9327-50171	110	880	0.401	Y	GT
912-8MX-85	9327-50179	114	912	0.490	Y	HTD
920-8MX-85	9327-50187	115	920	0.529	Y	GT
960-8MX-85	9327-50195	120	960	0.524	Y	GT
968-8MX-85	9327-50203	121	968	0.518	Y	HTD
976-8MX-85	9327-50211	122	976	0.529	Y	GT
1000-8MX-85	9327-50219	125	1000	0.535	Y	GT
1040-8MX-85	9327-50227	130	1040	0.567	Y	HTD
1064-8MX-85	9327-50235	133	1064	0.576	Y	HTD
1080-8MX-85	9327-50243	135	1080	0.584	Y	GT
1120-8MX-85	9327-50251	140	1120	0.609	Y	GT
1128-8MX-85	9327-50259	141	1128	0.601	Y	HTD
1160-8MX-85	9327-50267	145	1160	0.664	Y	HTD
1176-8MX-85	9327-50274	147	1176	0.681	N	HTD
1200-8MX-85	9327-50282	150	1200	0.652	Y	GT
1216-8MX-85	9327-50290	152	1216	0.659	Y	HTD
1224-8MX-85	9327-50298	153	1224	0.652	Y	HTD
1256-8MX-85	9327-50306	157	1256	0.669	Y	HTD
1264-8MX-85	9327-50314	158	1264	0.677	Y	HTD
1280-8MX-85	9327-50322	160	1280	0.657	Y	GT
1304-8MX-85	9327-50330	163	1304	0.694	Y	HTD
1360-8MX-85	9327-50338	170	1360	0.775	Y	HTD

8MM PITCH - 85 MM WIDE						
Item description	Product Number	Teeth	Pitch Length (mm)	Weight (kg)	Stock	Tooth profile
1424-8MX-85	9327-50346	178	1424	0.811	Y	HTD
1432-8MX-85	9327-50353	179	1432	0.816	N	HTD
1440-8MX-85	9327-50361	180	1440	0.737	Y	GT
1512-8MX-85	9327-50369	189	1512	0.810	Y	GT
1520-8MX-85	9327-50377	190	1520	0.816	Y	HTD
1552-8MX-85	9327-50385	194	1552	0.835	Y	HTD
1584-8MX-85	9327-50393	198	1584	0.848	Y	GT
1600-8MX-85	9327-50401	200	1600	0.818	Y	GT
1696-8MX-85	9327-50409	212	1696	0.911	Y	HTD
1728-8MX-85	9327-50416	216	1728	0.925	N	HTD
1760-8MX-85	9327-50424	220	1760	0.882	Y	GT
1800-8MX-85	9327-50432	225	1800	0.918	Y	GT
1880-8MX-85	9327-50439	235	1880	1.023	N	HTD
1896-8MX-85	9327-50447	237	1896	1.016	Y	HTD
1904-8MX-85	9327-50455	238	1904	1.021	Y	HTD
2000-8MX-85	9327-50463	250	2000	1.155	Y	HTD
2080-8MX-85	9327-50471	260	2080	1.131	Y	HTD
2200-8MX-85	9327-50478	275	2200	1.180	N	HTD
2240-8MX-85	9327-50486	280	2240	1.218	Y	HTD
2272-8MX-85	9327-50494	284	2272	1.236	Y	HTD
2400-8MX-85	9327-50502	300	2400	1.305	Y	HTD
2504-8MX-85	9327-50509	313	2504	1.341	N	HTD
2600-8MX-85	9327-50517	325	2600	1.414	Y	HTD
2800-8MX-85	9327-50525	350	2800	1.523	Y	HTD
3048-8MX-85	9327-50533	381	3048	1.492	Y	GT
3280-8MX-85	9327-50541	410	3280	1.606	Y	GT
3600-8MX-85	9327-50549	450	3600	1.763	Y	GT
4400-8MX-85	9327-50557	550	4400	2.154	Y	GT



POWERGRIP GTX BELTS AND SLABS - 8MX AND 14MX

8MM PITCH - SLABS							
Item description	Product Number	Teeth	Pitch Length (mm)	Weight (kg)	Stock	Width (inch)	Tooth profile
264-8MX	9326-50006	33	264	0.772	N	18	HTD
320-8MX	9326-50013	40	320	1.456	N	28	HTD
376-8MX	9326-50021	47	376	1.100	Y	18	HTD
384-8MX	9326-50029	48	384	1.639	Y	28	GT
424-8MX	9326-50038	53	424	1.929	Y	28	GT
472-8MX	9326-50205	59	472	2.147	Y	28	GT
480-8MX	9326-50045	60	480	2.184	Y	28	HTD
512-8MX	9326-50053	64	512	2.330	Y	28	HTD
520-8MX	9326-50061	65	520	1.521	Y	18	HTD
560-8MX	9326-50069	70	560	2.622	Y	28	HTD
576-8MX	9326-50077	72	576	1.685	Y	18	HTD
600-8MX	9326-50085	75	600	2.560	Y	28	GT
608-8MX	9326-50093	76	608	1.778	Y	18	HTD
624-8MX	9326-50101	78	624	2.622	Y	28	HTD
640-8MX	9326-50109	80	640	2.912	Y	28	HTD
656-8MX	9326-50118	82	656	2.985	Y	28	GT
720-8MX	9326-50125	90	720	3.276	Y	28	HTD
760-8MX	9326-50134	95	760	2.233	Y	18	GT
776-8MX	9326-50141	97	776	2.270	Y	18	HTD
800-8MX	9326-50149	100	800	2.194	Y	18	GT
840-8MX	9326-50164	105	840	2.303	Y	18	GT
856-8MX	9326-50156	107	856	2.622	N	18	HTD
880-8MX	9326-50172	110	880	2.413	Y	18	GT
912-8MX	9326-50180	114	912	4.150	Y	28	HTD
920-8MX	9326-50188	115	920	2.622	Y	18	GT
960-8MX	9326-50196	120	960	2.622	Y	18	GT
968-8MX	9326-50204	121	968	4.405	Y	28	HTD
976-8MX	9326-50213	122	976	2.622	Y	18	GT
1000-8MX	9326-50221	125	1000	2.925	Y	18	GT
1040-8MX	9326-50228	130	1040	4.732	Y	28	HTD
1064-8MX	9326-50236	133	1064	3.112	Y	18	HTD
1080-8MX	9326-50245	135	1080	3.159	Y	18	GT
1120-8MX	9326-50252	140	1120	2.949	Y	18	GT
1128-8MX	9326-50260	141	1128	3.299	Y	18	HTD
1160-8MX	9326-50268	145	1160	3.393	Y	18	HTD
1176-8MX	9326-50275	147	1176	5.351	N	28	HTD
1200-8MX	9326-50283	150	1200	3.290	Y	18	GT
1216-8MX	9326-50291	152	1216	3.557	Y	18	HTD
1224-8MX	9326-50299	153	1224	5.570	Y	28	HTD
1256-8MX	9326-50307	157	1256	5.715	Y	28	HTD
1264-8MX	9326-50316	158	1264	3.697	Y	18	HTD
1280-8MX	9326-50323	160	1280	3.510	Y	18	GT
1304-8MX	9326-50331	163	1304	5.934	Y	28	HTD
1360-8MX	9326-50340	170	1360	3.978	Y	18	HTD

8MM PITCH - SLABS							
Item description	Product Number	Teeth	Pitch Length (mm)	Weight (kg)	Stock	Width (inch)	Tooth profile
1424-8MX	9326-50347	178	1424	4.165	Y	18	HTD
1432-8MX	9326-50354	179	1432	4.188	N	18	HTD
1440-8MX	9326-50362	180	1440	3.948	Y	18	GT
1512-8MX	9326-50370	189	1512	4.148	Y	18	GT
1520-8MX	9326-50378	190	1520	4.446	Y	18	HTD
1552-8MX	9326-50387	194	1552	4.539	Y	18	HTD
1584-8MX	9326-50394	198	1584	4.343	Y	18	GT
1600-8MX	9326-50402	200	1600	4.387	Y	18	GT
1696-8MX	9326-50411	212	1696	4.960	Y	18	HTD
1728-8MX	9326-50417	216	1728	7.863	N	28	HTD
1760-8MX	9326-50425	220	1760	4.826	Y	18	GT
1800-8MX	9326-50433	225	1800	4.936	Y	18	GT
1880-8MX	9326-50441	235	1880	5.499	Y	18	HTD
1896-8MX	9326-50449	237	1896	5.545	Y	18	HTD
1904-8MX	9326-50456	238	1904	5.569	Y	18	HTD
2000-8MX	9326-51187	250	2000	9.101	Y	28	HTD
2080-8MX	9326-50473	260	2080	4.393	Y	13	HTD
2200-8MX	9326-50479	275	2200	4.646	N	13	HTD
2240-8MX	9326-50487	280	2240	4.731	Y	13	HTD
2272-8MX	9326-50495	284	2272	4.798	Y	13	HTD
2400-8MX	9326-50503	300	2400	5.069	Y	13	HTD
2504-8MX	9326-50510	313	2504	5.070	N	13	HTD
2600-8MX	9326-50518	325	2600	5.491	Y	13	HTD
2800-8MX	9326-50526	350	2800	5.914	Y	13	HTD
3048-8MX	9326-50534	381	3048	6.035	Y	13	GT
3280-8MX	9326-50542	410	3280	6.494	Y	13	GT
3600-8MX	9326-50550	450	3600	7.128	Y	13	GT
4400-8MX	9326-50558	550	4400	8.712	Y	13	GT

POWERGRIP GTX



POWERGRIP GTX BELTS AND SLABS - 8MX AND 14MX

14MM PITCH - 20 MM WIDE							14MM PITCH - 40 MM WIDE						
Item description	Product Number	Teeth	Pitch Length (mm)	Weight (kg)	Stock	Tooth profile	Item description	Product Number	Teeth	Pitch Length (mm)	Weight (kg)	Stock	Tooth profile
784-14MX-20	9327-50560	56	784	0.308	N	HTD	784-14MX-40	9327-50561	56	784	0.616	N	HTD
826-14MX-20	9327-50567	59	826	0.342	N	HTD	826-14MX-40	9327-50568	59	826	0.684	N	HTD
924-14MX-20	9327-50575	66	924	0.380	N	HTD	924-14MX-40	9327-50576	66	924	0.760	N	HTD
966-14MX-20	9327-50583	69	966	0.188	Y	HTD	966-14MX-40	9327-50584	69	966	0.375	Y	HTD
1092-14MX-20	9327-50591	78	1092	0.212	Y	HTD	1092-14MX-40	9327-50592	78	1092	0.424	Y	HTD
1190-14MX-20	9327-50599	85	1190	0.234	Y	GT	1190-14MX-40	9327-50600	85	1190	0.468	Y	GT
1400-14MX-20	9327-50607	100	1400	0.275	Y	GT	1400-14MX-40	9327-50608	100	1400	0.550	Y	GT
1610-14MX-20	9327-50615	115	1610	0.313	Y	GT	1610-14MX-40	9327-50616	115	1610	0.625	Y	GT
1750-14MX-20	9327-50623	125	1750	0.344	Y	GT	1750-14MX-40	9327-50624	125	1750	0.688	Y	GT
1778-14MX-20	9327-50631	127	1778	0.350	Y	GT	1778-14MX-40	9327-50632	127	1778	0.699	Y	GT
1890-14MX-20	9327-50639	135	1890	0.372	Y	GT	1890-14MX-40	9327-50640	135	1890	0.743	Y	GT
2100-14MX-20	9327-51007	150	2100	0.413	Y	GT	2100-14MX-40	9327-51008	150	2100	0.825	Y	GT
2310-14MX-20	9327-51015	165	2310	0.448	Y	GT	2310-14MX-40	9327-51016	165	2310	0.896	Y	GT
2450-14MX-20	9327-51023	175	2450	0.475	Y	HTD	2450-14MX-40	9327-51024	175	2450	0.950	Y	HTD
2590-14MX-20	9327-51031	185	2590	0.503	Y	GT	2590-14MX-40	9327-51032	185	2590	1.005	Y	GT
2800-14MX-20	9327-51039	200	2800	0.551	Y	GT	2800-14MX-40	9327-51040	200	2800	1.101	Y	GT
3150-14MX-20	9327-51047	225	3150	0.612	Y	GT	3150-14MX-40	9327-51048	225	3150	1.223	Y	GT
3500-14MX-20	9327-51055	250	3500	0.688	Y	GT	3500-14MX-40	9327-51056	250	3500	1.376	Y	GT
3850-14MX-20	9327-51063	275	3850	0.757	Y	GT	3850-14MX-40	9327-51064	275	3850	1.513	Y	GT
4004-14MX-20	9327-51071	286	4004	0.777	Y	HTD	4004-14MX-40	9327-51072	286	4004	1.553	Y	HTD
4326-14MX-20	9327-51079	309	4326	0.850	Y	GT	4326-14MX-40	9327-51080	309	4326	1.700	Y	GT
4578-14MX-20	9327-51087	327	4578	0.888	Y	HTD	4578-14MX-40	9327-51088	327	4578	1.776	Y	HTD



POWERGRIP GTX BELTS AND SLABS - 8MX AND 14MX

14MM PITCH - 55 MM WIDE						
Item description	Product Number	Teeth	Pitch Length (mm)	Weight (kg)	Stock	Tooth profile
784-14MX-55	9327-50562	56	784	0.434	N	HTD
826-14MX-55	9327-50569	59	826	0.456	N	HTD
924-14MX-55	9327-50577	66	924	0.591	N	HTD
966-14MX-55	9327-50585	69	966	0.530	Y	HTD
1092-14MX-55	9327-50593	78	1092	0.596	Y	HTD
1190-14MX-55	9327-50601	85	1190	0.729	Y	GT
1400-14MX-55	9327-50609	100	1400	0.757	Y	GT
1610-14MX-55	9327-50617	115	1610	0.859	Y	GT
1750-14MX-55	9327-50625	125	1750	0.934	Y	GT
1778-14MX-55	9327-50633	127	1778	0.961	Y	GT
1890-14MX-55	9327-51001	135	1890	1.021	Y	GT
2100-14MX-55	9327-51009	150	2100	1.135	Y	GT
2310-14MX-55	9327-51017	165	2310	1.232	Y	GT
2450-14MX-55	9327-51025	175	2450	1.307	Y	HTD
2590-14MX-55	9327-51033	185	2590	1.381	Y	GT
2800-14MX-55	9327-51041	200	2800	1.514	Y	GT
3150-14MX-55	9327-51049	225	3150	1.681	Y	GT
3500-14MX-55	9327-51057	250	3500	1.892	Y	GT
3850-14MX-55	9327-51065	275	3850	2.080	Y	GT
4004-14MX-55	9327-51073	286	4004	2.135	Y	HTD
4326-14MX-55	9327-51081	309	4326	2.246	Y	GT
4578-14MX-55	9327-51089	327	4578	2.403	Y	HTD

14MM PITCH - 85 MM WIDE						
Item description	Product Number	Teeth	Pitch Length (mm)	Weight (kg)	Stock	Tooth profile
784-14MX-85	9327-50563	56	784	0.781	N	HTD
826-14MX-85	9327-50570	59	826	0.821	N	HTD
924-14MX-85	9327-50578	66	924	0.914	N	HTD
966-14MX-85	9327-50586	69	966	0.797	Y	HTD
1092-14MX-85	9327-50594	78	1092	0.901	Y	HTD
1190-14MX-85	9327-50602	85	1190	0.994	Y	GT
1400-14MX-85	9327-50610	100	1400	1.169	Y	GT
1610-14MX-85	9327-50618	115	1610	1.327	Y	GT
1750-14MX-85	9327-50626	125	1750	1.443	Y	GT
1778-14MX-85	9327-50634	127	1778	1.485	Y	GT
1890-14MX-85	9327-51002	135	1890	1.578	Y	GT
2100-14MX-85	9327-51010	150	2100	1.753	Y	GT
2310-14MX-85	9327-51018	165	2310	1.904	Y	GT
2450-14MX-85	9327-51026	175	2450	2.019	Y	HTD
2590-14MX-85	9327-51034	185	2590	2.135	Y	GT
2800-14MX-85	9327-51042	200	2800	2.339	Y	GT
3150-14MX-85	9327-51050	225	3150	2.598	Y	GT
3500-14MX-85	9327-51058	250	3500	2.924	Y	GT
3850-14MX-85	9327-51066	275	3850	3.214	Y	GT
4004-14MX-85	9327-51074	286	4004	3.300	Y	HTD
4326-14MX-85	9327-51082	309	4326	5.001	Y	GT
4578-14MX-85	9327-51090	327	4578	3.773	Y	HTD

POWERGRIP GTX



POWERGRIP GTX BELTS AND SLABS - 8MX AND 14MX

14MM PITCH - 115 MM WIDE						
Item description	Product Number	Teeth	Pitch Length (mm)	Weight (kg)	Stock	Tooth profile
784-14MX-115	9327-50564	56	784	1.457	N	HTD
826-14MX-115	9327-50571	59	826	1.026	N	HTD
924-14MX-115	9327-50579	66	924	1.236	N	HTD
966-14MX-115	9327-50587	69	966	1.078	Y	HTD
1092-14MX-115	9327-50595	78	1092	1.234	Y	HTD
1190-14MX-115	9327-50603	85	1190	1.344	Y	GT
1400-14MX-115	9327-50611	100	1400	1.581	Y	GT
1610-14MX-115	9327-50619	115	1610	1.796	Y	GT
1750-14MX-115	9327-50627	125	1750	1.952	Y	GT
1778-14MX-115	9327-50635	127	1778	2.008	Y	GT
1890-14MX-115	9327-51003	135	1890	2.135	Y	GT
2100-14MX-115	9327-51011	150	2100	2.372	Y	GT
2310-14MX-115	9327-51019	165	2310	2.576	Y	GT
2450-14MX-115	9327-51027	175	2450	2.732	Y	HTD
2590-14MX-115	9327-51035	185	2590	2.888	Y	GT
2800-14MX-115	9327-51043	200	2800	3.164	Y	GT
3150-14MX-115	9327-51051	225	3150	3.514	Y	GT
3500-14MX-115	9327-51059	250	3500	3.955	Y	GT
3850-14MX-115	9327-51067	275	3850	4.348	Y	GT
4004-14MX-115	9327-51075	286	4004	4.464	Y	HTD
4326-14MX-115	9327-51083	309	4326	4.885	Y	GT
4578-14MX-115	9327-51091	327	4578	5.104	Y	HTD

14MM PITCH - 170 MM WIDE						
Item description	Product Number	Teeth	Pitch Length (mm)	Weight (kg)	Stock	Tooth profile
784-14MX-170	9327-50565	56	784	1.953	N	HTD
826-14MX-170	9327-50572	59	826	2.053	N	HTD
924-14MX-170	9327-50580	66	924	1.828	N	HTD
966-14MX-170	9327-50588	69	966	1.593	Y	HTD
1092-14MX-170	9327-50596	78	1092	1.801	Y	HTD
1190-14MX-170	9327-50604	85	1190	1.987	Y	GT
1400-14MX-170	9327-50612	100	1400	2.337	Y	GT
1610-14MX-170	9327-50620	115	1610	2.654	Y	GT
1750-14MX-170	9327-50628	125	1750	2.885	Y	GT
1778-14MX-170	9327-50636	127	1778	2.969	Y	GT
1890-14MX-170	9327-51004	135	1890	3.155	Y	GT
2100-14MX-170	9327-51012	150	2100	3.506	Y	GT
2310-14MX-170	9327-51020	165	2310	3.807	Y	GT
2450-14MX-170	9327-51028	175	2450	4.038	Y	HTD
2590-14MX-170	9327-51036	185	2590	4.269	Y	GT
2800-14MX-170	9327-51044	200	2800	4.677	Y	GT
3150-14MX-170	9327-51052	225	3150	6.237	Y	GT
3500-14MX-170	9327-51060	250	3500	5.847	Y	GT
3850-14MX-170	9327-51068	275	3850	6.427	Y	GT
4004-14MX-170	9327-51076	286	4004	6.599	Y	HTD
4326-14MX-170	9327-51084	309	4326	7.222	Y	GT
4578-14MX-170	9327-51092	327	4578	7.545	Y	HTD



POWERGRIP GTX BELTS AND SLABS - 8MX AND 14MX

14MM PITCH - SLABS							
Item description	Product Number	Teeth	Pitch Length (mm)	Weight (kg)	Stock	Width (inch)	Tooth profile
784-14MX	9326-50566	56	784	3.457	N	18	HTD
826-14MX	9326-50573	59	826	3.662	N	18	HTD
924-14MX	9326-50581	66	924	4.096	N	18	HTD
966-14MX	9326-50589	69	966	4.282	Y	18	HTD
1092-14MX	9326-50597	78	1092	4.841	Y	18	HTD
1190-14MX	9326-50605	85	1190	3.858	Y	13	GT
1400-14MX	9326-50613	100	1400	4.539	Y	13	GT
1610-14MX	9326-50622	115	1610	5.156	Y	13	GT
1750-14MX	9326-50629	125	1750	5.674	Y	13	GT
1778-14MX	9326-50637	127	1778	5.765	Y	13	GT
1890-14MX	9326-51005	135	1890	6.128	Y	13	GT
2100-14MX	9326-51013	150	2100	6.809	Y	13	GT
2310-14MX	9326-50623	165	2310	7.394	Y	13	GT
2450-14MX	9326-51029	175	2450	7.842	Y	13	HTD
2590-14MX	9326-51037	185	2590	8.291	Y	13	GT
2800-14MX	9326-51045	200	2800	9.084	Y	13	GT
3150-14MX	9326-51053	225	3150	10.089	Y	13	GT
3500-14MX	9326-51061	250	3500	11.355	Y	13	GT
3850-14MX	9326-51069	275	3850	12.483	Y	13	GT
4004-14MX	9326-50624	286	4004	12.817	Y	13	GT
4326-14MX	9326-51085	309	4326	14.026	Y	13	GT
4578-14MX	9326-51093	327	4578	14.654	Y	13	HTD

POWERGRIP GT4 BELTS AND SLABS - 8MGT AND 14MGT

Recommended Sprockets

PowerGrip HTD/GT Sprockets

NOTES: 8M and 14M PowerGrip GT4 belts are static conductive in accordance with ISO 9653 and for conditions described in the Directive 2014/34/EU-ATEX. Belt pitch is the distance in millimeters between two adjacent tooth centers as measured on the pitch line of the belt. Belt pitch length is the total length (circumference) in millimeters as measured along the pitch line. The theoretical pitch line of a PowerGrip GT4 belt lies within the tensile member. PowerGrip GT4 part numbers are comprised of pitch length, pitch, and width. For example, part number 3150-14MGT-55 denotes a 3150mm pitch length, 14mm pitch, and 55mm width. Synchronous pitch length is always a multiple of the belt pitch.

Item description build up: length-pitch-width

8MM PITCH - 20 MM WIDE					
Item description	Product Number	Teeth	Pitch Length (mm)	Weight (kg)	Stock
384-8MGT4-20	9579-50408	48	384	0.038	Y
424-8MGT4-20	9579-50200	53	424	0.042	Y
472-8MGT4-20	9579-50204	59	472	0.046	Y
480-8MGT4-20	9579-50300	60	480	0.047	Y
560-8MGT4-20	9579-50304	70	560	0.055	Y
576-8MGT4-20	9579-01041	72	576	0.056	Y
600-8MGT4-20	9579-50308	75	600	0.059	Y
640-8MGT4-20	9579-50312	80	640	0.063	Y
656-8MGT4-20	9579-50208	82	656	0.064	Y
720-8MGT4-20	9579-50316	90	720	0.070	Y
760-8MGT4-20	9579-50212	95	760	0.074	Y
800-8MGT4-20	9579-50320	100	800	0.078	Y
840-8MGT4-20	9579-50412	105	840	0.082	Y
880-8MGT4-20	9579-50324	110	880	0.086	Y
920-8MGT4-20	9579-50396	115	920	0.090	Y
960-8MGT4-20	9579-50328	120	960	0.094	Y
976-8MGT4-20	9579-50216	122	976	0.095	Y
1000-8MGT4-20	9579-50220	125	1000	0.098	Y
1040-8MGT4-20	9579-50332	130	1040	0.101	Y
1064-8MGT4-20	9579-41101	133	1064	0.104	Y
1080-8MGT4-20	9579-50224	135	1080	0.105	Y
1104-8MGT4-20	9579-01037	138	1104	0.108	Y
1120-8MGT4-20	9579-50336	140	1120	0.109	Y
1160-8MGT4-20	9579-41105	145	1160	0.113	Y
1200-8MGT4-20	9579-50340	150	1200	0.117	Y
1224-8MGT4-20	9579-01029	153	1224	0.119	Y
1264-8MGT4-20	9579-50228	158	1264	0.123	Y
1280-8MGT4-20	9579-50344	160	1280	0.125	Y
1360-8MGT4-20	9579-50232	170	1360	0.132	Y
1440-8MGT4-20	9579-50348	180	1440	0.140	Y
1512-8MGT4-20	9579-50400	189	1512	0.147	Y
1552-8MGT4-20	9579-50236	194	1552	0.151	Y
1584-8MGT4-20	9579-50404	198	1584	0.154	Y
1600-8MGT4-20	9579-50352	200	1600	0.156	Y

8MM PITCH - 20 MM WIDE					
Item description	Product Number	Teeth	Pitch Length (mm)	Weight (kg)	Stock
1696-8MGT4-20	9579-50240	212	1696	0.165	Y
1760-8MGT4-20	9579-50356	220	1760	0.171	Y
1800-8MGT4-20	9579-50360	225	1800	0.175	Y
1880-8MGT4-20	9579-50244	235	1880	0.183	Y
1896-8MGT4-20	9579-50248	237	1896	0.184	Y
2000-8MGT4-20	9579-50364	250	2000	0.194	Y
2080-8MGT4-20	9579-50252	260	2080	0.202	Y
2200-8MGT4-20	9579-01033	275	2200	0.214	Y
2400-8MGT4-20	9579-50368	300	2400	0.233	Y
2600-8MGT4-20	9579-50376	325	2600	0.253	Y
2800-8MGT4-20	9579-50372	350	2800	0.272	Y
3048-8MGT4-20	9579-50380	381	3048	0.296	Y
3280-8MGT4-20	9579-50384	410	3280	0.319	Y
3600-8MGT4-20	9579-50388	450	3600	0.350	Y
4400-8MGT4-20	9579-50392	550	4400	0.427	Y



POWERGRIP GT4 BELTS AND SLABS - 8MGT AND 14MGT

8MM PITCH - 30 MM WIDE					
Item description	Product Number	Teeth	Pitch Length (mm)	Weight (kg)	Stock
384-8MGT4-30	9579-50409	48	384	0.056	Y
424-8MGT4-30	9579-50201	53	424	0.062	Y
472-8MGT4-30	9579-50205	59	472	0.069	Y
480-8MGT4-30	9579-50301	60	480	0.070	Y
560-8MGT4-30	9579-50305	70	560	0.082	Y
576-8MGT4-30	9579-01043	72	576	0.084	Y
600-8MGT4-30	9579-50309	75	600	0.088	Y
640-8MGT4-30	9579-50313	80	640	0.094	Y
656-8MGT4-30	9579-50209	82	656	0.096	Y
720-8MGT4-30	9579-50317	90	720	0.105	Y
760-8MGT4-30	9579-50213	95	760	0.111	Y
800-8MGT4-30	9579-50321	100	800	0.117	Y
840-8MGT4-30	9579-50413	105	840	0.123	Y
880-8MGT4-30	9579-50325	110	880	0.129	Y
920-8MGT4-30	9579-50397	115	920	0.134	Y
960-8MGT4-30	9579-50329	120	960	0.140	Y
976-8MGT4-30	9579-50217	122	976	0.143	Y
1000-8MGT4-30	9579-50221	125	1000	0.146	Y
1040-8MGT4-30	9579-50333	130	1040	0.152	Y
1064-8MGT4-30	9579-41102	133	1064	0.155	Y
1080-8MGT4-30	9579-50225	135	1080	0.158	Y
1104-8MGT4-30	9579-01038	138	1104	0.161	Y
1120-8MGT4-30	9579-50337	140	1120	0.163	Y
1160-8MGT4-30	9579-41106	145	1160	0.169	Y
1200-8MGT4-30	9579-50341	150	1200	0.175	Y
1224-8MGT4-30	9579-01030	153	1224	0.179	Y
1264-8MGT4-30	9579-50229	158	1264	0.184	Y
1280-8MGT4-30	9579-50345	160	1280	0.187	Y
1360-8MGT4-30	9579-50233	170	1360	0.198	Y
1440-8MGT4-30	9579-50349	180	1440	0.210	Y
1512-8MGT4-30	9579-50401	189	1512	0.220	Y
1552-8MGT4-30	9579-50237	194	1552	0.226	Y
1584-8MGT4-30	9579-50405	198	1584	0.231	Y
1600-8MGT4-30	9579-50353	200	1600	0.233	Y
1696-8MGT4-30	9579-50241	212	1696	0.247	Y
1760-8MGT4-30	9579-50357	220	1760	0.257	Y
1800-8MGT4-30	9579-50361	225	1800	0.262	Y
1880-8MGT4-30	9579-50245	235	1880	0.274	Y
1896-8MGT4-30	9579-50249	237	1896	0.276	Y
2000-8MGT4-30	9579-50365	250	2000	0.291	Y
2080-8MGT4-30	9579-50253	260	2080	0.303	Y
2200-8MGT4-30	9579-01034	275	2200	0.321	Y
2400-8MGT4-30	9579-50369	300	2400	0.350	Y
2600-8MGT4-30	9579-50377	325	2600	0.379	Y
2800-8MGT4-30	9579-50373	350	2800	0.408	Y
3048-8MGT4-30	9579-50381	381	3048	0.444	Y
3280-8MGT4-30	9579-50385	410	3280	0.478	Y
3600-8MGT4-30	9579-50389	450	3600	0.524	Y
4400-8MGT4-30	9579-50393	550	4400	0.641	Y

8MM PITCH - 50 MM WIDE					
Item description	Product Number	Teeth	Pitch Length (mm)	Weight (kg)	Stock
384-8MGT4-50	9579-50410	48	384	0.094	Y
424-8MGT4-50	9579-50202	53	424	0.103	Y
472-8MGT4-50	9579-50206	59	472	0.115	Y
480-8MGT4-50	9579-50302	60	480	0.117	Y
560-8MGT4-50	9579-50306	70	560	0.136	Y
576-8MGT4-50	9579-01042	72	576	0.138	Y
600-8MGT4-50	9579-50310	75	600	0.146	Y
640-8MGT4-50	9579-50314	80	640	0.156	Y
656-8MGT4-50	9579-50210	82	656	0.160	Y
720-8MGT4-50	9579-50318	90	720	0.175	Y
760-8MGT4-50	9579-50214	95	760	0.185	Y
800-8MGT4-50	9579-50322	100	800	0.194	Y
840-8MGT4-50	9579-50414	105	840	0.204	Y
880-8MGT4-50	9579-50326	110	880	0.214	Y
920-8MGT4-50	9579-50398	115	920	0.224	Y
960-8MGT4-50	9579-50330	120	960	0.233	Y
976-8MGT4-50	9579-50218	122	976	0.237	Y
1000-8MGT4-50	9579-50222	125	1000	0.243	Y
1040-8MGT4-50	9579-50334	130	1040	0.253	Y
1064-8MGT4-50	9579-41103	133	1064	0.259	Y
1080-8MGT4-50	9579-55555	135	1080	0.262	Y
1104-8MGT4-50	9579-01039	138	1104	0.268	Y
1120-8MGT4-50	9579-50338	140	1120	0.272	Y
1160-8MGT4-50	9579-41107	145	1160	0.282	Y
1200-8MGT4-50	9579-50342	150	1200	0.291	Y
1224-8MGT4-50	9579-01031	153	1224	0.297	Y
1264-8MGT4-50	9579-50230	158	1264	0.307	Y
1280-8MGT4-50	9579-50346	160	1280	0.311	Y
1360-8MGT4-50	9579-50234	170	1360	0.330	Y
1440-8MGT4-50	9579-50350	180	1440	0.350	Y
1512-8MGT4-50	9579-50402	189	1512	0.367	Y
1552-8MGT4-50	9579-50238	194	1552	0.377	Y
1584-8MGT4-50	9579-50406	198	1584	0.385	Y
1600-8MGT4-50	9579-50354	200	1600	0.388	Y
1696-8MGT4-50	9579-50242	212	1696	0.412	Y
1760-8MGT4-50	9579-50358	220	1760	0.427	Y
1800-8MGT4-50	9579-50362	225	1800	0.437	Y
1880-8MGT4-50	9579-50246	235	1880	0.456	Y
1896-8MGT4-50	9579-50250	237	1896	0.460	Y
2000-8MGT4-50	9579-50366	250	2000	0.485	Y
2080-8MGT4-50	9579-50254	260	2080	0.505	Y
2200-8MGT4-50	9579-01035	275	2200	0.534	Y
2400-8MGT4-50	9579-50370	300	2400	0.582	Y
2600-8MGT4-50	9579-50378	325	2600	0.631	Y
2800-8MGT4-50	9579-50374	350	2800	0.679	Y
3048-8MGT4-50	9579-50382	381	3048	0.740	Y
3280-8MGT4-50	9579-50386	410	3280	0.796	Y
3600-8MGT4-50	9579-50390	450	3600	0.873	Y
4400-8MGT4-50	9579-50394	550	4400	1.067	Y

POWERGRIP GT4

POWERGRIP GT4 BELTS AND SLABS - 8MGT AND 14MGT

8MM PITCH - 85 MM WIDE					
Item description	Product Number	Teeth	Pitch Length (mm)	Weight (kg)	Stock
384-8MGT4-85	9579-50411	48	384	0.159	Y
424-8MGT4-85	9579-50203	53	424	0.175	Y
472-8MGT4-85	9579-50207	59	472	0.195	Y
480-8MGT4-85	9579-50303	60	480	0.198	Y
560-8MGT4-85	9579-50307	70	560	0.231	Y
576-8MGT4-85	9579-01044	72	576	0.235	Y
600-8MGT4-85	9579-50311	75	600	0.248	Y
640-8MGT4-85	9579-50315	80	640	0.264	Y
656-8MGT4-85	9579-50211	82	656	0.271	Y
720-8MGT4-85	9579-50319	90	720	0.297	Y
760-8MGT4-85	9579-50215	95	760	0.314	Y
800-8MGT4-85	9579-50323	100	800	0.330	Y
840-8MGT4-85	9579-50415	105	840	0.347	Y
880-8MGT4-85	9579-50327	110	880	0.363	Y
920-8MGT4-85	9579-50399	115	920	0.380	Y
960-8MGT4-85	9579-50331	120	960	0.396	Y
976-8MGT4-85	9579-50219	122	976	0.403	Y
1000-8MGT4-85	9579-50223	125	1000	0.413	Y
1040-8MGT4-85	9579-50335	130	1040	0.429	Y
1064-8MGT4-85	9579-41104	133	1064	0.439	Y
1080-8MGT4-85	9579-50227	135	1080	0.446	Y
1104-8MGT4-85	9579-01040	138	1104	0.456	Y
1120-8MGT4-85	9579-50339	140	1120	0.462	Y
1160-8MGT4-85	9579-41108	145	1160	0.479	Y
1200-8MGT4-85	9579-50343	150	1200	0.495	Y
1224-8MGT4-85	9579-01032	153	1224	0.505	Y
1264-8MGT4-85	9579-50231	158	1264	0.522	Y
1280-8MGT4-85	9579-50347	160	1280	0.528	Y
1360-8MGT4-85	9579-50235	170	1360	0.561	Y
1440-8MGT4-85	9579-50351	180	1440	0.594	Y
1512-8MGT4-85	9579-50403	189	1512	0.624	Y
1552-8MGT4-85	9579-50239	194	1552	0.640	Y
1584-8MGT4-85	9579-50407	198	1584	0.654	Y
1600-8MGT4-85	9579-50355	200	1600	0.660	Y
1696-8MGT4-85	9579-50243	212	1696	0.700	Y
1760-8MGT4-85	9579-50359	220	1760	0.726	Y
1800-8MGT4-85	9579-50363	225	1800	0.743	Y
1880-8MGT4-85	9579-50247	235	1880	0.776	Y
1896-8MGT4-85	9579-50251	237	1896	0.782	Y
2000-8MGT4-85	9579-50367	250	2000	0.825	Y
2080-8MGT4-85	9579-50255	260	2080	0.858	Y
2200-8MGT4-85	9579-01036	275	2200	0.907	Y
2400-8MGT4-85	9579-50371	300	2400	0.990	Y
2600-8MGT4-85	9579-50379	325	2600	1.072	Y
2800-8MGT4-85	9579-50375	350	2800	1.155	Y
3048-8MGT4-85	9579-50383	381	3048	1.257	Y
3280-8MGT4-85	9579-50387	410	3280	1.353	Y
3600-8MGT4-85	9579-50391	450	3600	1.485	Y
4400-8MGT4-85	9579-50395	550	4400	1.814	Y

8MM PITCH - SLABS						
Item description	Product Number	Teeth	Pitch Length (mm)	Weight (kg)	Stock	Width (inch)
384-8MGT4	9577-59300	48	384	1.325	Y	28
424-8MGT4	9577-59356	53	424	1.463	Y	28
472-8MGT4	9577-59355	59	472	1.629	Y	28
480-8MGT4	9577-59328	60	480	1.656	Y	28
560-8MGT4	9577-59327	70	560	1.932	Y	28
576-8MGT4	9577-00020	72	576	1.987	Y	28
600-8MGT4	9577-59326	75	600	2.070	Y	28
640-8MGT4	9577-59325	80	640	2.208	Y	28
656-8MGT4	9577-59357	82	656	2.264	Y	28
720-8MGT4	9577-59324	90	720	2.484	Y	28
760-8MGT4	9577-59358	95	760	1.686	Y	18
800-8MGT4	9577-59323	100	800	1.774	Y	18
840-8MGT4	9577-59301	105	840	1.863	Y	18
880-8MGT4	9577-59322	110	880	1.952	Y	18
920-8MGT4	9577-59302	115	920	2.041	Y	18
960-8MGT4	9577-59321	120	960	2.129	Y	18
976-8MGT4	9577-59359	122	976	2.165	Y	18
1000-8MGT4	9577-59360	125	1000	2.218	Y	18
1040-8MGT4	9577-59320	130	1040	2.307	Y	18
1064-8MGT4	9577-49109	133	1064	2.360	Y	18
1080-8MGT4	9577-59361	135	1080	2.396	Y	18
1104-8MGT4	9577-00019	138	1104	3.809	Y	28
1120-8MGT4	9577-59319	140	1120	2.484	Y	18
1160-8MGT4	9577-49110	145	1160	2.573	Y	18
1200-8MGT4	9577-59318	150	1200	2.661	Y	18
1224-8MGT4	9577-00012	153	1224	4.222	Y	28
1264-8MGT4	9577-59362	158	1264	2.804	Y	18
1280-8MGT4	9577-59317	160	1280	2.839	Y	18
1360-8MGT4	9577-59363	170	1360	3.017	Y	18
1440-8MGT4	9577-59316	180	1440	3.194	Y	18
1512-8MGT4	9577-59303	189	1512	3.353	Y	18
1552-8MGT4	9577-59364	194	1552	3.443	Y	18
1584-8MGT4	9577-59304	198	1584	3.513	Y	18
1600-8MGT4	9577-59315	200	1600	3.548	Y	18
1696-8MGT4	9577-59365	212	1696	3.762	Y	18
1760-8MGT4	9577-59314	220	1760	3.903	Y	18
1800-8MGT4	9577-59313	225	1800	3.992	Y	18
1880-8MGT4	9577-59366	235	1880	4.170	Y	18
1896-8MGT4	9577-59367	237	1896	4.206	Y	18
2000-8MGT4	9577-09283	250	2000	5.940	Y	23
2080-8MGT4	9577-59368	260	2080	3.332	Y	13
2200-8MGT4	9577-00017	275	2200	6.234	Y	23
2400-8MGT4	9577-09282	300	2400	6.801	Y	23
2600-8MGT4	9577-09281	325	2600	7.240	Y	22
2800-8MGT4	9577-09280	350	2800	8.300	Y	22
3048-8MGT4	9577-59308	381	3048	4.882	Y	13
3280-8MGT4	9577-59307	410	3280	5.253	Y	13
3600-8MGT4	9577-59306	450	3600	5.766	Y	13
4400-8MGT4	9577-59305	550	4400	7.047	Y	13

POWERGRIP GT4



POWERGRIP GT4 BELTS AND SLABS - 8MGT AND 14MGT

14MM PITCH - 40 MM WIDE					
Item description	Product Number	Teeth	Pitch Length (mm)	Weight (kg)	Stock
966-14MGT4-40	9579-00100	69	966	0.329	Y
1190-14MGT4-40	9579-50000	85	1190	0.405	Y
1400-14MGT4-40	9579-50005	100	1400	0.476	Y
1610-14MGT4-40	9579-50115	115	1610	0.548	Y
1750-14MGT4-40	9579-50044	125	1750	0.595	Y
1778-14MGT4-40	9579-50010	127	1778	0.605	Y
1890-14MGT4-40	9579-50015	135	1890	0.643	Y
2100-14MGT4-40	9579-50020	150	2100	0.714	Y
2310-14MGT4-40	9579-50135	165	2310	0.786	Y
2450-14MGT4-40	9579-00140	175	2450	0.833	Y
2590-14MGT4-40	9579-00145	185	2590	0.881	Y
2800-14MGT4-40	9579-50025	200	2800	0.952	Y
3150-14MGT4-40	9579-50030	225	3150	1.071	Y
3360-14MGT4-40	9579-00180	240	3360	1.143	Y
3500-14MGT4-40	9579-50035	250	3500	1.190	Y
3850-14MGT4-40	9579-50040	275	3850	1.309	Y
4004-14MGT4-40	9579-50256	286	4004	1.362	Y
4326-14MGT4-40	9579-00170	309	4326	1.471	Y
4578-14MGT4-40	9579-50175	327	4578	1.557	Y
4956-14MGT4-40	9579-00185	354	4956	1.686	Y
5320-14MGT4-40	9579-00190	380	5320	1.809	Y
5740-14MGT4-40	9579-00195	410	5740	1.952	Y
6160-14MGT4-40	9579-00200	440	6160	2.095	Y
6860-14MGT4-40	9579-00205	490	6860	2.333	Y

14MM PITCH - 55 MM WIDE					
Item description	Product Number	Teeth	Pitch Length (mm)	Weight (kg)	Stock
966-14MGT4-55	9579-00101	69	966	0.452	Y
1190-14MGT4-55	9579-50001	85	1190	0.557	Y
1400-14MGT4-55	9579-50006	100	1400	0.655	Y
1610-14MGT4-55	9579-50116	115	1610	0.548	Y
1750-14MGT4-55	9579-50045	125	1750	0.819	Y
1778-14MGT4-55	9579-50011	127	1778	0.832	Y
1890-14MGT4-55	9579-50016	135	1890	0.884	Y
2100-14MGT4-55	9579-50021	150	2100	0.982	Y
2310-14MGT4-55	9579-50136	165	2310	1.081	Y
2450-14MGT4-55	9579-00141	175	2450	1.146	Y
2590-14MGT4-55	9579-00146	185	2590	1.211	Y
2800-14MGT4-55	9579-50026	200	2800	1.309	Y
3150-14MGT4-55	9579-50031	225	3150	1.473	Y
3360-14MGT4-55	9579-00181	240	3360	1.571	Y
3500-14MGT4-55	9579-50036	250	3500	1.637	Y
3850-14MGT4-55	9579-50041	275	3850	1.800	Y
4004-14MGT4-55	9579-50257	286	4004	1.873	Y
4326-14MGT4-55	9579-00171	309	4326	2.023	Y
4578-14MGT4-55	9579-50176	327	4578	2.141	Y
4956-14MGT4-55	9579-00186	354	4956	2.317	Y
5320-14MGT4-55	9579-00191	380	5320	2.488	Y
5740-14MGT4-55	9579-00196	410	5740	2.684	Y
6160-14MGT4-55	9579-00201	440	6160	2.880	Y
6860-14MGT4-55	9579-00206	490	6860	3.208	Y



POWERGRIP GT4 BELTS AND SLABS - 8MGT AND 14MGT

14MM PITCH - 85 MM WIDE						14MM PITCH - 115 MM WIDE					
Item description	Product Number	Teeth	Pitch Length (mm)	Weight (kg)	Stock	Item description	Product Number	Teeth	Pitch Length (mm)	Weight (kg)	Stock
966-14MGT4-85	9579-00102	69	966	0.698	Y	966-14MGT4-115	9579-00103	69	966	0.945	Y
1190-14MGT4-85	9579-50002	85	1190	0.860	Y	1190-14MGT4-115	9579-50003	85	1190	1.164	Y
1400-14MGT4-85	9579-50007	100	1400	1.012	Y	1400-14MGT4-115	9579-50008	100	1400	1.369	Y
1610-14MGT4-85	9579-50117	115	1610	1.164	Y	1610-14MGT4-115	9579-00118	115	1610	1.574	Y
1750-14MGT4-85	9579-50046	125	1750	1.265	Y	1750-14MGT4-115	9579-50047	125	1750	1.711	Y
1778-14MGT4-85	9579-50012	127	1778	1.285	Y	1778-14MGT4-115	9579-50013	127	1778	1.738	Y
1890-14MGT4-85	9579-50017	135	1890	1.366	Y	1890-14MGT4-115	9579-50018	135	1890	1.848	Y
2100-14MGT4-85	9579-50022	150	2100	1.518	Y	2100-14MGT4-115	9579-50023	150	2100	2.053	Y
2310-14MGT4-85	9579-50137	165	2310	1.670	Y	2310-14MGT4-115	9579-00138	165	2310	2.259	Y
2450-14MGT4-85	9579-00142	175	2450	1.771	Y	2450-14MGT4-115	9579-00143	175	2450	2.395	Y
2590-14MGT4-85	9579-00147	185	2590	1.872	Y	2590-14MGT4-115	9579-00148	185	2590	2.532	Y
2800-14MGT4-85	9579-50027	200	2800	2.023	Y	2800-14MGT4-115	9579-50028	200	2800	2.737	Y
3150-14MGT4-85	9579-50032	225	3150	2.276	Y	3150-14MGT4-115	9579-50033	225	3150	3.080	Y
3360-14MGT4-85	9579-00182	240	3360	2.428	Y	3360-14MGT4-115	9579-00183	240	3360	3.285	Y
3500-14MGT4-85	9579-50037	250	3500	2.529	Y	3500-14MGT4-115	9579-50038	250	3500	3.422	Y
3850-14MGT4-85	9579-50042	275	3850	2.782	Y	3850-14MGT4-115	9579-50043	275	3850	3.764	Y
4004-14MGT4-85	9579-50258	286	4004	2.894	Y	4004-14MGT4-115	9579-50259	286	4004	3.915	Y
4326-14MGT4-85	9579-00172	309	4326	3.126	Y	4326-14MGT4-115	9579-00173	309	4326	4.229	Y
4578-14MGT4-85	9579-50177	327	4578	3.308	Y	4578-14MGT4-115	9579-50178	327	4578	4.475	Y
4956-14MGT4-85	9579-00187	354	4956	3.581	Y	4956-14MGT4-115	9579-00188	354	4956	4.845	Y
5320-14MGT4-85	9579-00192	380	5320	3.844	Y	5320-14MGT4-115	9579-00193	380	5320	5.201	Y
5740-14MGT4-85	9579-00197	410	5740	4.148	Y	5740-14MGT4-115	9579-00198	410	5740	5.611	Y
6160-14MGT4-85	9579-00202	440	6160	4.451	Y	6160-14MGT4-115	9579-00203	440	6160	6.022	Y
6860-14MGT4-85	9579-00207	490	6860	4.957	Y	6860-14MGT4-115	9579-00208	490	6860	6.706	Y



POWERGRIP GT4 BELTS AND SLABS - 8MGT AND 14MGT

14MM PITCH - 170 MM WIDE					
Item description	Product Number	Teeth	Pitch Length (mm)	Weight (kg)	Stock
966-14MGT4-170	9579-00104	69	966	1.396	Y
1190-14MGT4-170	9579-50004	85	1190	1.720	Y
1400-14MGT4-170	9579-50009	100	1400	2.023	Y
1610-14MGT4-170	9579-00119	115	1610	2.327	Y
1750-14MGT4-170	9579-50048	125	1750	2.529	Y
1778-14MGT4-170	9579-50014	127	1778	2.570	Y
1890-14MGT4-170	9579-50019	135	1890	2.732	Y
2100-14MGT4-170	9579-50024	150	2100	3.035	Y
2310-14MGT4-170	9579-00139	165	2310	3.338	Y
2450-14MGT4-170	9579-00144	175	2450	3.541	Y
2590-14MGT4-170	9579-00149	185	2590	3.743	Y
2800-14MGT4-170	9579-50029	200	2800	4.046	Y
3150-14MGT4-170	9579-50034	225	3150	4.552	Y
3360-14MGT4-170	9579-00184	240	3360	4.856	Y
3500-14MGT4-170	9579-50039	250	3500	5.058	Y
3850-14MGT4-170	9579-50049	275	3850	5.564	Y
4004-14MGT4-170	9579-50260	286	4004	5.787	Y
4326-14MGT4-170	9579-00174	309	4326	6.252	Y
4578-14MGT4-170	9579-50179	327	4578	6.616	Y
4956-14MGT4-170	9579-00189	354	4956	7.162	Y
5320-14MGT4-170	9579-00194	380	5320	7.688	Y
5740-14MGT4-170	9579-00199	410	5740	8.295	Y
6160-14MGT4-170	9579-00204	440	6160	8.902	Y
6860-14MGT4-170	9579-00209	490	6860	9.913	Y

14MM PITCH - SLABS						
Item description	Product Number	Teeth	Pitch Length (mm)	Weight (kg)	Stock	Width (inch)
966-14MGT4	9577-09399	69	966	2.920	Y	14
1190-14MGT4	9577-59008	85	1190	3.340	Y	13
1400-14MGT4	9577-59007	100	1400	3.930	Y	13
1610-14MGT4	9577-59396	115	1610	4.520	Y	13
1750-14MGT4	9577-59009	125	1750	4.912	Y	13
1778-14MGT4	9577-59006	127	1778	4.991	Y	13
1890-14MGT4	9577-59005	135	1890	5.305	Y	13
2100-14MGT4	9577-59004	150	2100	5.895	Y	13
2310-14MGT4	9577-59392	165	2310	6.485	Y	13
2450-14MGT4	9577-09391	175	2450	7.406	Y	14
2590-14MGT4	9577-09390	185	2590	7.810	Y	14
2800-14MGT4	9577-59003	200	2800	7.859	Y	13
3150-14MGT4	9577-59002	225	3150	8.842	Y	13
3360-14MGT4	9577-09387	240	3360	10.120	Y	14
3500-14MGT4	9577-59001	250	3500	9.824	Y	13
3850-14MGT4	9577-59000	275	3850	10.806	Y	13
4004-14MGT4	9577-59010	286	4004	11.240	Y	13
4326-14MGT4	9577-09384	309	4326	12.142	Y	13
4578-14MGT4	9577-59383	327	4578	12.850	Y	13
4956-14MGT4	9577-09382	354	4956	15.360	Y	14
5320-14MGT4	9577-09381	380	5320	16.760	Y	14
5740-14MGT4	9577-09380	410	5740	17.960	Y	14
6160-14MGT4	9577-09379	440	6160	17.720	Y	14
6860-14MGT4	9577-09378	490	6860	21.480	Y	14

POWERGRIP GT3 BELTS AND SLABS - 2MGT, 3MGT AND 5MGT

Recommended Sprockets

PowerGrip GT Sprockets

NOTES: Belt pitch is the distance in millimeters between two adjacent tooth centers as measured on the pitch line of the belt. Belt pitch length is the total length (circumference) in millimeters as measured along the pitch line. The theoretical pitch line of a PowerGrip GT3 belt lies within the tensile member.

PowerGrip GT3 part numbers are comprised of pitch length, pitch and width. For example; part number 216-2MGT-3 denotes a 216mm pitch length, 2mm pitch and 3mm width. Synchronous pitch length is always a multiple of the belt pitch.

Item description build up: length-pitch-width

2MM PITCH - 3 MM WIDE					
Item description	Product Number	Teeth	Pitch Length (mm)	Weight (kg)	Stock
152-2MGT3-3	9400-52239	76	152	0.001	Y
158-2MGT3-3	9400-54001	79	158	0.001	Y
164-2MGT3-3	9400-54002	82	164	0.001	Y
168-2MGT3-3	9400-54003	84	168	0.001	Y
172-2MGT3-3	9400-54004	86	172	0.001	Y
178-2MGT3-3	9400-54005	89	178	0.001	Y
180-2MGT3-3	9400-54006	90	180	0.001	Y
184-2MGT3-3	9400-54007	92	184	0.001	Y
186-2MGT3-3	9400-54008	93	186	0.001	Y
192-2MGT3-3	9400-54009	96	192	0.001	Y
194-2MGT3-3	9400-54010	97	194	0.003	Y
202-2MGT3-3	9400-54011	101	202	0.001	Y
208-2MGT3-3	9400-54012	104	208	0.001	Y
210-2MGT3-3	9400-54013	105	210	0.001	Y
212-2MGT3-3	9400-54014	106	212	0.001	Y
216-2MGT3-3	9400-54015	108	216	0.001	Y
220-2MGT3-3	9400-54016	110	220	0.001	Y
224-2MGT3-3	9400-54017	112	224	0.001	Y
232-2MGT3-3	9400-42192	116	232	0.002	Y
240-2MGT3-3	9400-54018	120	240	0.002	Y
242-2MGT3-3	9400-54019	121	242	0.002	Y
250-2MGT3-3	9400-54020	125	250	0.002	Y
252-2MGT3-3	9400-54021	126	252	0.002	Y
264-2MGT3-3	9400-54022	132	264	0.002	Y
274-2MGT3-3	9400-54023	137	274	0.001	Y
280-2MGT3-3	9400-54024	140	280	0.002	Y
284-2MGT3-3	9400-54025	142	284	0.002	Y
286-2MGT3-3	9400-54026	143	286	0.001	Y
288-2MGT3-3	9400-54027	144	288	0.002	Y
304-2MGT3-3	9400-54028	152	304	0.002	Y
310-2MGT3-3	9400-54029	155	310	0.002	Y
318-2MGT3-3	9400-54030	159	318	0.002	Y
320-2MGT3-3	9400-54031	160	320	0.002	Y
322-2MGT3-3	9400-54032	161	322	0.002	Y
330-2MGT3-3	9400-54033	165	330	0.002	Y

2MM PITCH - 3 MM WIDE					
Item description	Product Number	Teeth	Pitch Length (mm)	Weight (kg)	Stock
332-2MGT3-3	9400-54034	166	332	0.002	Y
336-2MGT3-3	9400-54035	168	336	0.002	Y
342-2MGT3-3	9400-54036	171	342	0.002	Y
356-2MGT3-3	9400-54037	178	356	0.002	Y
364-2MGT3-3	9400-54038	182	364	0.002	Y
370-2MGT3-3	9400-54039	185	370	0.002	Y
380-2MGT3-3	9400-54040	190	380	0.002	Y
386-2MGT3-3	9400-54041	193	386	0.001	Y
392-2MGT3-3	9400-54042	196	392	0.002	Y
400-2MGT3-3	9400-54043	200	400	0.002	Y
406-2MGT3-3	9400-54044	203	406	0.003	Y
412-2MGT3-3	9400-54045	206	412	0.003	Y
420-2MGT3-3	9400-54046	210	420	0.003	Y
428-2MGT3-3	9400-54047	214	428	0.002	Y
430-2MGT3-3	9400-54048	215	430	0.002	Y
436-2MGT3-3	9400-54049	218	436	0.003	Y
466-2MGT3-3	9400-54050	233	466	0.003	Y
474-2MGT3-3	9400-54051	237	474	0.003	Y
480-2MGT3-3	9400-54052	240	480	0.003	Y
488-2MGT3-3	9400-54053	244	488	0.003	Y
502-2MGT3-3	9400-54054	251	502	0.003	Y
516-2MGT3-3	9400-54055	258	516	0.003	Y
534-2MGT3-3	9400-54056	267	534	0.003	Y
544-2MGT3-3	9400-54057	272	544	0.003	Y
576-2MGT3-3	9400-54058	288	576	0.003	Y
600-2MGT3-3	9400-54059	300	600	0.004	Y
660-2MGT3-3	9400-42204	330	660	0.004	N
690-2MGT3-3	9400-54060	345	690	0.004	Y
816-2MGT3-3	9400-42180	408	816	0.005	N
930-2MGT3-3	9400-54061	465	930	0.006	Y
1830-2MGT3-3	9400-42188	915	1830	0.011	Y



POWERGRIP GT3 BELTS AND SLABS - 2MGT, 3MGT AND 5MGT

2MM PITCH - 6 MM WIDE					
Item description	Product Number	Teeth	Pitch Length (mm)	Weight (kg)	Stock
152-2MGT3-6	9400-42171	76	152	0.002	N
158-2MGT3-6	9400-54066	79	158	0.002	Y
164-2MGT3-6	9400-54067	82	164	0.002	Y
168-2MGT3-6	9400-54068	84	168	0.002	Y
172-2MGT3-6	9400-54069	86	172	0.002	Y
178-2MGT3-6	9400-54070	89	178	0.002	Y
180-2MGT3-6	9400-42211	90	180	0.002	Y
184-2MGT3-6	9400-54071	92	184	0.002	Y
186-2MGT3-6	9400-54072	93	186	0.002	Y
192-2MGT3-6	9400-42184	96	192	0.002	Y
194-2MGT3-6	9400-52234	97	194	0.005	Y
202-2MGT3-6	9400-54073	101	202	0.003	Y
208-2MGT3-6	9400-54074	104	208	0.003	Y
210-2MGT3-6	9400-54075	105	210	0.003	Y
212-2MGT3-6	9400-54076	106	212	0.003	Y
216-2MGT3-6	9400-54077	108	216	0.003	Y
220-2MGT3-6	9400-54078	110	220	0.002	Y
224-2MGT3-6	9400-54079	112	224	0.003	Y
232-2MGT3-6	9400-42178	116	232	0.003	N
240-2MGT3-6	9400-54080	120	240	0.003	Y
242-2MGT3-6	9400-54081	121	242	0.003	Y
250-2MGT3-6	9400-54082	125	250	0.003	Y
252-2MGT3-6	9400-42179	126	252	0.003	Y
264-2MGT3-6	9400-54083	132	264	0.003	Y
274-2MGT3-6	9400-52202	137	274	0.003	N
280-2MGT3-6	9400-54084	140	280	0.003	Y
284-2MGT3-6	9400-54085	142	284	0.004	Y
286-2MGT3-6	9400-54086	143	286	0.002	Y
288-2MGT3-6	9400-54087	144	288	0.003	Y
304-2MGT3-6	9400-54088	152	304	0.004	Y
310-2MGT3-6	9400-54089	155	310	0.004	Y
318-2MGT3-6	9400-54090	159	318	0.004	Y
320-2MGT3-6	9400-54091	160	320	0.004	Y
322-2MGT3-6	9400-54092	161	322	0.004	Y
330-2MGT3-6	9400-54093	165	330	0.004	Y
332-2MGT3-6	9400-54094	166	332	0.003	Y
336-2MGT3-6	9400-54095	168	336	0.004	Y
342-2MGT3-6	9400-54096	171	342	0.004	Y
356-2MGT3-6	9400-54097	178	356	0.004	Y
364-2MGT3-6	9400-54098	182	364	0.004	Y
370-2MGT3-6	9400-54099	185	370	0.005	Y
380-2MGT3-6	9400-54100	190	380	0.005	Y
386-2MGT3-6	9400-54101	193	386	0.003	Y
392-2MGT3-6	9400-54102	196	392	0.004	Y

2MM PITCH - 6 MM WIDE					
Item description	Product Number	Teeth	Pitch Length (mm)	Weight (kg)	Stock
400-2MGT3-6	9400-52201	200	400	0.004	N
406-2MGT3-6	9400-42170	203	406	0.005	Y
412-2MGT3-6	9400-42172	206	412	0.005	N
420-2MGT3-6	9400-54103	210	420	0.005	Y
428-2MGT3-6	9400-54104	214	428	0.004	Y
430-2MGT3-6	9400-54105	215	430	0.005	Y
436-2MGT3-6	9400-42173	218	436	0.005	N
466-2MGT3-6	9400-54106	233	466	0.006	Y
474-2MGT3-6	9400-54107	237	474	0.006	Y
480-2MGT3-6	9400-54108	240	480	0.005	Y
488-2MGT3-6	9400-54109	244	488	0.005	Y
502-2MGT3-6	9400-42169	251	502	0.005	N
516-2MGT3-6	9400-54110	258	516	0.005	Y
534-2MGT3-6	9400-42168	267	534	0.006	Y
544-2MGT3-6	9400-54111	272	544	0.007	Y
576-2MGT3-6	9400-54112	288	576	0.007	Y
600-2MGT3-6	9400-54113	300	600	0.007	Y
660-2MGT3-6	9400-54114	330	660	0.008	Y
690-2MGT3-6	9400-54115	345	690	0.007	Y
816-2MGT3-6	9400-42220	408	816	0.010	Y
930-2MGT3-6	9400-54116	465	930	0.011	Y
1032-2MGT3-6	9400-54117	516	1032	0.012	Y
1164-2MGT3-6	9400-54118	582	1164	0.014	Y
1386-2MGT3-6	9400-54119	693	1386	0.016	Y
1700-2MGT3-6	9400-54120	850	1700	0.021	Y
1830-2MGT3-6	9400-54121	915	1830	0.023	Y

POWERGRIP GT3

POWERGRIP GT3 BELTS AND SLABS - 2MGT, 3MGT AND 5MGT

2MM PITCH - 9 MM WIDE					
Item description	Product Number	Teeth	Pitch Length (mm)	Weight (kg)	Stock
152-2MGT3-9	9400-54122	76	152	0.003	Y
158-2MGT3-9	9400-42216	79	158	0.003	N
164-2MGT3-9	9400-54123	82	164	0.003	Y
168-2MGT3-9	9400-54124	84	168	0.003	Y
172-2MGT3-9	9400-54125	86	172	0.004	Y
178-2MGT3-9	9400-54126	89	178	0.003	Y
180-2MGT3-9	9400-54127	90	180	0.003	Y
184-2MGT3-9	9400-54128	92	184	0.004	Y
186-2MGT3-9	9400-54129	93	186	0.004	Y
192-2MGT3-9	9400-54130	96	192	0.004	Y
194-2MGT3-9	9400-54131	97	194	0.008	Y
202-2MGT3-9	9400-54132	101	202	0.004	Y
208-2MGT3-9	9400-54133	104	208	0.004	Y
210-2MGT3-9	9400-54134	105	210	0.004	Y
212-2MGT3-9	9400-54135	106	212	0.004	Y
216-2MGT3-9	9400-54136	108	216	0.004	Y
220-2MGT3-9	9400-54137	110	220	0.003	Y
224-2MGT3-9	9400-54138	112	224	0.004	Y
232-2MGT3-9	9400-54139	116	232	0.005	Y
240-2MGT3-9	9400-54140	120	240	0.005	Y
242-2MGT3-9	9400-42209	121	242	0.004	N
250-2MGT3-9	9400-54141	125	250	0.005	Y
252-2MGT3-9	9400-54142	126	252	0.005	Y
264-2MGT3-9	9400-54143	132	264	0.005	Y
274-2MGT3-9	9400-54144	137	274	0.004	Y
280-2MGT3-9	9400-54145	140	280	0.005	Y
284-2MGT3-9	9400-54146	142	284	0.005	Y
286-2MGT3-9	9400-54147	143	286	0.004	Y
288-2MGT3-9	9400-54148	144	288	0.005	Y
304-2MGT3-9	9400-54149	152	304	0.006	Y
310-2MGT3-9	9400-54150	155	310	0.006	Y
318-2MGT3-9	9400-54151	159	318	0.006	Y
320-2MGT3-9	9400-54152	160	320	0.006	Y
322-2MGT3-9	9400-54153	161	322	0.006	Y
330-2MGT3-9	9400-54154	165	330	0.006	Y
332-2MGT3-9	9400-54155	166	332	0.005	Y
336-2MGT3-9	9400-54156	168	336	0.006	Y
342-2MGT3-9	9400-54157	171	342	0.006	Y
356-2MGT3-9	9400-54158	178	356	0.006	Y
364-2MGT3-9	9400-54159	182	364	0.006	Y
370-2MGT3-9	9400-54160	185	370	0.007	Y
380-2MGT3-9	9400-54161	190	380	0.007	Y
386-2MGT3-9	9400-54162	193	386	0.006	Y
392-2MGT3-9	9400-54163	196	392	0.006	Y

2MM PITCH - 9 MM WIDE					
Item description	Product Number	Teeth	Pitch Length (mm)	Weight (kg)	Stock
400-2MGT3-9	9400-54164	200	400	0.006	Y
406-2MGT3-9	9400-54165	203	406	0.008	Y
412-2MGT3-9	9400-54166	206	412	0.008	Y
420-2MGT3-9	9400-54167	210	420	0.008	Y
428-2MGT3-9	9400-54168	214	428	0.007	Y
430-2MGT3-9	9400-54169	215	430	0.007	Y
436-2MGT3-9	9400-54170	218	436	0.008	Y
466-2MGT3-9	9400-54171	233	466	0.008	Y
474-2MGT3-9	9400-54172	237	474	0.009	Y
480-2MGT3-9	9400-54173	240	480	0.008	Y
488-2MGT3-9	9400-54174	244	488	0.008	Y
502-2MGT3-9	9400-52244	251	502	0.008	N
516-2MGT3-9	9400-54175	258	516	0.008	Y
534-2MGT3-9	9400-54176	267	534	0.010	Y
544-2MGT3-9	9400-54177	272	544	0.010	Y
576-2MGT3-9	9400-54178	288	576	0.009	Y
600-2MGT3-9	9400-54179	300	600	0.011	Y
660-2MGT3-9	9400-54180	330	660	0.012	Y
690-2MGT3-9	9400-54181	345	690	0.011	Y
816-2MGT3-9	9400-54182	408	816	0.015	Y
930-2MGT3-9	9400-54183	465	930	0.017	Y
1032-2MGT3-9	9400-54184	516	1032	0.018	Y
1164-2MGT3-9	9400-54185	582	1164	0.021	Y
1386-2MGT3-9	9400-54186	693	1386	0.025	Y
1700-2MGT3-9	9400-54187	850	1700	0.032	Y
1830-2MGT3-9	9400-54188	915	1830	0.034	Y

POWERGRIP GT3 BELTS AND SLABS - 2MGT, 3MGT AND 5MGT

2MM PITCH - SLABS						
Item description	Product Number	Teeth	Pitch Length (mm)	Weight (kg)	Stock	Width (inch)
74-2MGT3	9400-42159	37	74	0.057	N	18
76-2MGT3	9400-42133	38	76	0.058	N	18
80-2MGT3	9400-42160	40	80	0.061	N	18
90-2MGT3	9400-42161	45	90	0.069	N	18
100-2MGT3	9400-42114	50	100	0.076	N	18
112-2MGT3	9400-42115	56	112	0.085	N	18
130-2MGT3	9400-52023	66	130	0.077	N	14
132-2MGT3	9400-52006	66	132	0.101	N	18
134-2MGT3	9400-52040	67	134	0.080	N	14
140-2MGT3	9400-42134	70	140	0.219	N	28
142-2MGT3	9400-42116	71	142	0.108	N	18
152-2MGT3	9400-42136	76	152	0.235	Y	28
158-2MGT3	9400-52037	79	158	0.188	Y	28
164-2MGT3	9400-52011	82	164	0.204	Y	28
168-2MGT3	9400-52024	84	168	0.199	Y	28
172-2MGT3	9400-52025	86	172	0.204	Y	28
178-2MGT3	9400-42147	89	178	0.271	Y	28
180-2MGT3	9400-42143	90	180	0.274	Y	28
184-2MGT3	9400-52039	92	184	0.219	Y	28
186-2MGT3	9400-42138	93	186	0.279	Y	28
192-2MGT3	9400-42186	96	192	0.291	Y	28
194-2MGT3	9400-52021	97	194	0.230	Y	28
202-2MGT3	9400-42162	101	202	0.301	Y	28
208-2MGT3	9400-52036	104	208	0.247	Y	28
210-2MGT3	9400-52260	105	210	0.249	Y	28
212-2MGT3	9400-42121	106	212	0.215	Y	18
216-2MGT3	9400-52034	108	216	0.257	Y	28
220-2MGT3	9400-52013	110	220	0.274	Y	28
224-2MGT3	9400-42142	112	224	0.331	Y	28
232-2MGT3	9400-52273	116	232	0.276	Y	28
240-2MGT3	9400-42018	120	240	0.241	Y	18
242-2MGT3	9400-42166	121	242	0.359	Y	28
250-2MGT3	9400-52026	125	250	0.267	Y	28
252-2MGT3	9400-42125	126	252	0.253	Y	18
264-2MGT3	9400-42139	132	264	0.390	Y	28
274-2MGT3	9400-52014	137	274	0.341	Y	28
280-2MGT3	9400-42148	140	280	0.409	Y	28
284-2MGT3	9400-42149	142	284	0.418	Y	28
286-2MGT3	9400-42126	143	286	0.340	Y	28
288-2MGT3	9400-52012	144	288	0.358	Y	28
304-2MGT3	9400-42141	152	304	0.442	Y	28
310-2MGT3	9400-42163	155	310	0.451	Y	28
318-2MGT3	9400-42150	159	318	0.465	Y	28
320-2MGT3	9400-42240	160	320	0.465	Y	28

2MM PITCH - SLABS						
Item description	Product Number	Teeth	Pitch Length (mm)	Weight (kg)	Stock	Width (inch)
322-2MGT3	9400-42151	161	322	0.470	Y	28
330-2MGT3	9400-42152	165	330	0.392	Y	28
332-2MGT3	9400-52009	166	332	0.413	Y	28
336-2MGT3	9400-42164	168	336	0.490	Y	28
342-2MGT3	9400-42241	171	342	0.406	Y	28
356-2MGT3	9400-52007	178	356	0.443	Y	28
364-2MGT3	9400-52003	182	364	0.432	Y	28
370-2MGT3	9400-42153	185	370	0.439	Y	28
380-2MGT3	9400-42135	190	380	0.451	Y	28
386-2MGT3	9400-52004	193	386	0.458	Y	28
392-2MGT3	9400-52000	196	392	0.314	Y	18
400-2MGT3	9400-52015	200	400	0.498	Y	28
406-2MGT3	9400-42127	203	406	0.397	Y	18
412-2MGT3	9400-42154	206	412	0.489	Y	28
420-2MGT3	9400-42155	210	420	0.499	Y	28
428-2MGT3	9400-52001	214	428	0.533	Y	28
430-2MGT3	9400-52002	215	430	0.535	Y	28
436-2MGT3	9400-42156	218	436	0.518	Y	28
466-2MGT3	9400-42157	233	466	0.553	Y	28
474-2MGT3	9400-42130	237	474	0.678	Y	28
480-2MGT3	9400-52020	240	480	0.597	Y	28
488-2MGT3	9400-52005	244	488	0.607	Y	28
502-2MGT3	9400-52035	251	502	0.596	Y	28
516-2MGT3	9400-52016	258	516	0.642	Y	28
534-2MGT3	9400-42158	267	534	0.634	Y	28
544-2MGT3	9400-42112	272	544	0.415	Y	18
576-2MGT3	9400-52277	288	576	0.440	Y	18
600-2MGT3	9400-42243	300	600	0.712	Y	28
660-2MGT3	9400-42129	330	660	0.634	Y	18
690-2MGT3	9400-52017	345	690	0.819	Y	28
816-2MGT3	9400-42131	408	816	0.780	Y	18
930-2MGT3	9400-42137	465	930	1.104	Y	28
1032-2MGT3	9400-42144	516	1032	1.225	Y	28
1164-2MGT3	9400-42132	582	1164	1.382	Y	28
1386-2MGT3	9400-42145	693	1386	1.646	Y	28
1700-2MGT3	9400-42113	850	1700	1.607	Y	18
1830-2MGT3	9400-42165	915	1830	1.727	Y	18

POWERGRIP GT3 BELTS AND SLABS - 2MGT, 3MGT AND 5MGT

3MM PITCH - 6 MM WIDE					
Item description	Product Number	Teeth	Pitch Length (mm)	Weight (kg)	Stock
105-3MGT3-6	9400-43209	35	105	0.002	N
120-3MGT3-6	9400-53258	40	120	0.002	N
135-3MGT3-6	9400-53259	45	135	0.002	N
144-3MGT3-6	9400-53289	48	144	0.002	N
150-3MGT3-6	9400-53260	50	150	0.002	Y
165-3MGT3-6	9400-53249	55	165	0.004	Y
174-3MGT3-6	9400-53350	58	174	0.003	Y
180-3MGT3-6	9400-53250	60	180	0.003	Y
186-3MGT3-6	9400-53292	62	186	0.003	Y
192-3MGT3-6	9400-53295	64	192	0.003	Y
195-3MGT3-6	9400-53221	65	195	0.003	Y
204-3MGT3-6	9400-53298	68	204	0.003	Y
210-3MGT3-6	9400-53256	70	210	0.003	Y
216-3MGT3-6	9400-43212	72	216	0.003	Y
225-3MGT3-6	9400-53233	75	225	0.003	Y
231-3MGT3-6	9400-53301	77	231	0.003	Y
234-3MGT3-6	9400-53356	78	234	0.004	Y
240-3MGT3-6	9400-53204	80	240	0.003	Y
243-3MGT3-6	9400-53304	81	243	0.004	Y
246-3MGT3-6	9400-53306	82	246	0.004	Y
252-3MGT3-6	9400-43272	84	252	0.005	Y
255-3MGT3-6	9400-53261	85	255	0.004	Y
267-3MGT3-6	9400-43186	89	267	0.004	Y
270-3MGT3-6	9400-53255	90	270	0.004	Y
276-3MGT3-6	9400-53309	92	276	0.004	Y
282-3MGT3-6	9400-53359	94	282	0.002	Y
285-3MGT3-6	9400-53205	95	285	0.004	Y
288-3MGT3-6	9400-53312	96	288	0.004	Y
294-3MGT3-6	9400-53345	98	294	0.004	Y
300-3MGT3-6	9400-53206	100	300	0.004	Y
303-3MGT3-6	9400-43237	101	303	0.001	Y
309-3MGT3-6	9400-53329	103	309	0.005	Y
312-3MGT3-6	9400-53314	104	312	0.005	Y
324-3MGT3-6	9400-53317	108	324	0.005	Y
330-3MGT3-6	9400-53252	110	330	0.005	Y
339-3MGT3-6	9400-53332	113	339	0.005	Y
354-3MGT3-6	9400-53362	118	354	0.001	Y
357-3MGT3-6	9400-43214	119	357	0.005	Y
360-3MGT3-6	9400-53262	120	360	0.005	Y
363-3MGT3-6	9400-43203	121	363	0.005	Y
375-3MGT3-6	9400-53319	125	375	0.005	Y
384-3MGT3-6	9400-43204	128	384	0.006	Y
387-3MGT3-6	9400-53353	129	387	0.006	Y
390-3MGT3-6	9400-53207	130	390	0.006	Y

3MM PITCH - 6 MM WIDE					
Item description	Product Number	Teeth	Pitch Length (mm)	Weight (kg)	Stock
393-3MGT3-6	9400-43217	131	393	0.007	Y
399-3MGT3-6	9400-53365	133	399	0.007	Y
408-3MGT3-6	9400-43190	136	408	0.006	Y
420-3MGT3-6	9400-53251	140	420	0.006	Y
426-3MGT3-6	9400-43233	142	426	0.008	Y
450-3MGT3-6	9400-53245	150	450	0.007	Y
456-3MGT3-6	9400-43234	152	456	0.007	Y
480-3MGT3-6	9400-53208	160	480	0.007	Y
489-3MGT3-6	9400-43223	163	489	0.007	Y
495-3MGT3-6	9400-53322	165	495	0.007	Y
501-3MGT3-6	9400-53209	167	501	0.007	Y
510-3MGT3-6	9400-53210	170	510	0.007	Y
513-3MGT3-6	9400-43193	171	513	0.007	Y
522-3MGT3-6	9400-43227	174	522	0.008	Y
537-3MGT3-6	9400-43195	179	537	0.008	Y
540-3MGT3-6	9400-53263	180	540	0.008	Y
552-3MGT3-6	9400-53285	184	552	0.008	Y
561-3MGT3-6	9400-53368	187	561	0.008	Y
564-3MGT3-6	9400-53211	188	564	0.008	Y
570-3MGT3-6	9400-53212	190	570	0.008	Y
582-3MGT3-6	9400-43206	194	582	0.008	Y
588-3MGT3-6	9400-53335	196	588	0.009	Y
600-3MGT3-6	9400-53264	200	600	0.009	Y
621-3MGT3-6	9400-53371	207	621	0.011	Y
630-3MGT3-6	9400-53213	210	630	0.009	Y
657-3MGT3-6	9400-43201	219	657	0.011	Y
750-3MGT3-6	9400-53338	250	750	0.011	Y
777-3MGT3-6	9400-43249	259	777	0.014	Y
840-3MGT3-6	9400-53348	280	840	0.012	Y
849-3MGT3-6	9400-53327	283	849	0.012	Y
897-3MGT3-6	9400-43230	299	897	0.013	Y
1587-3MGT3-6	9400-53281	529	1587	0.023	Y
1692-3MGT3-6	9400-53342	564	1692	0.025	Y



POWERGRIP GT3 BELTS AND SLABS - 2MGT, 3MGT AND 5MGT

3MM PITCH - 9 MM WIDE					
Item description	Product Number	Teeth	Pitch Length (mm)	Weight (kg)	Stock
105-3MGT3-9	9400-43210	35	105	0.003	N
120-3MGT3-9	9400-53232	40	120	0.003	N
135-3MGT3-9	9400-53222	45	135	0.003	N
144-3MGT3-9	9400-53290	48	144	0.003	N
150-3MGT3-9	9400-53231	50	150	0.003	Y
165-3MGT3-9	9400-53230	55	165	0.004	Y
174-3MGT3-9	9400-53351	58	174	0.004	Y
180-3MGT3-9	9400-53219	60	180	0.004	Y
186-3MGT3-9	9400-53293	62	186	0.004	Y
192-3MGT3-9	9400-53296	64	192	0.004	Y
195-3MGT3-9	9400-53201	65	195	0.004	Y
204-3MGT3-9	9400-53299	68	204	0.004	Y
210-3MGT3-9	9400-53223	70	210	0.005	Y
216-3MGT3-9	9400-43213	72	216	0.005	Y
225-3MGT3-9	9400-53202	75	225	0.005	Y
231-3MGT3-9	9400-53302	77	231	0.005	Y
234-3MGT3-9	9400-53357	78	234	0.003	Y
240-3MGT3-9	9400-53247	80	240	0.005	Y
243-3MGT3-9	9400-53286	81	243	0.005	Y
246-3MGT3-9	9400-53307	82	246	0.005	Y
252-3MGT3-9	9400-43207	84	252	0.006	Y
255-3MGT3-9	9400-53203	85	255	0.006	Y
267-3MGT3-9	9400-53283	89	267	0.006	Y
270-3MGT3-9	9400-53242	90	270	0.006	Y
276-3MGT3-9	9400-53310	92	276	0.006	Y
282-3MGT3-9	9400-53360	94	282	0.007	Y
285-3MGT3-9	9400-53214	95	285	0.006	Y
288-3MGT3-9	9400-53313	96	288	0.006	Y
294-3MGT3-9	9400-53346	98	294	0.006	Y
300-3MGT3-9	9400-53243	100	300	0.007	Y
303-3MGT3-9	9400-43238	101	303	0.002	Y
309-3MGT3-9	9400-53330	103	309	0.007	Y
312-3MGT3-9	9400-53315	104	312	0.007	Y
324-3MGT3-9	9400-53318	108	324	0.008	Y
330-3MGT3-9	9400-53227	110	330	0.007	Y
339-3MGT3-9	9400-53333	113	339	0.007	Y
354-3MGT3-9	9400-53363	118	354	0.002	Y
357-3MGT3-9	9400-43187	119	357	0.008	Y
360-3MGT3-9	9400-53220	120	360	0.008	Y
363-3MGT3-9	9400-43202	121	363	0.010	Y
375-3MGT3-9	9400-53320	125	375	0.008	Y
384-3MGT3-9	9400-43205	128	384	0.008	Y
387-3MGT3-9	9400-53354	129	387	0.008	Y
390-3MGT3-9	9400-53257	130	390	0.009	Y

3MM PITCH - 9 MM WIDE					
Item description	Product Number	Teeth	Pitch Length (mm)	Weight (kg)	Stock
393-3MGT3-9	9400-43218	131	393	0.009	Y
399-3MGT3-9	9400-53366	133	399	0.011	Y
408-3MGT3-9	9400-43199	136	408	0.011	Y
420-3MGT3-9	9400-53239	140	420	0.009	Y
426-3MGT3-9	9400-43200	142	426	0.009	Y
450-3MGT3-9	9400-53228	150	450	0.010	Y
456-3MGT3-9	9400-43235	152	456	0.012	Y
480-3MGT3-9	9400-53237	160	480	0.010	Y
489-3MGT3-9	9400-43224	163	489	0.011	Y
495-3MGT3-9	9400-53284	165	495	0.011	Y
501-3MGT3-9	9400-53323	167	501	0.011	Y
510-3MGT3-9	9400-53226	170	510	0.011	Y
513-3MGT3-9	9400-43225	171	513	0.011	Y
522-3MGT3-9	9400-43228	174	522	0.011	Y
537-3MGT3-9	9400-43196	179	537	0.013	Y
540-3MGT3-9	9400-53229	180	540	0.012	Y
552-3MGT3-9	9400-53325	184	552	0.012	Y
561-3MGT3-9	9400-53369	187	561	0.015	Y
564-3MGT3-9	9400-53280	188	564	0.012	Y
570-3MGT3-9	9400-53265	190	570	0.012	Y
582-3MGT3-9	9400-43236	194	582	0.016	Y
588-3MGT3-9	9400-53336	196	588	0.013	Y
600-3MGT3-9	9400-53266	200	600	0.013	Y
621-3MGT3-9	9400-53372	207	621	0.015	Y
630-3MGT3-9	9400-53248	210	630	0.014	Y
657-3MGT3-9	9400-43198	219	657	0.014	Y
750-3MGT3-9	9400-53339	250	750	0.016	Y
777-3MGT3-9	9400-43250	259	777	0.021	Y
840-3MGT3-9	9400-53349	280	840	0.018	Y
849-3MGT3-9	9400-53328	283	849	0.019	Y
897-3MGT3-9	9400-43231	299	897	0.024	Y
1587-3MGT3-9	9400-53200	529	1587	0.035	Y
1692-3MGT3-9	9400-53343	564	1692	0.037	Y

POWERGRIP GT3

POWERGRIP GT3 BELTS AND SLABS - 2MGT, 3MGT AND 5MGT

3MM PITCH - 15 MM WIDE					
Item description	Product Number	Teeth	Pitch Length (mm)	Weight (kg)	Stock
105-3MGT3-15	9400-43208	35	105	0.004	N
120-3MGT3-15	9400-53267	40	120	0.004	N
135-3MGT3-15	9400-53268	45	135	0.005	N
144-3MGT3-15	9400-53288	48	144	0.006	N
150-3MGT3-15	9400-53253	50	150	0.005	Y
165-3MGT3-15	9400-53244	55	165	0.006	Y
174-3MGT3-15	9400-53352	58	174	0.006	Y
180-3MGT3-15	9400-53254	60	180	0.007	Y
186-3MGT3-15	9400-53291	62	186	0.007	Y
192-3MGT3-15	9400-53294	64	192	0.007	Y
195-3MGT3-15	9400-53269	65	195	0.007	Y
204-3MGT3-15	9400-53297	68	204	0.007	Y
210-3MGT3-15	9400-53270	70	210	0.008	Y
216-3MGT3-15	9400-43211	72	216	0.008	Y
225-3MGT3-15	9400-53238	75	225	0.008	Y
231-3MGT3-15	9400-53300	77	231	0.008	Y
234-3MGT3-15	9400-53358	78	234	0.005	Y
240-3MGT3-15	9400-53218	80	240	0.009	Y
243-3MGT3-15	9400-53303	81	243	0.009	Y
246-3MGT3-15	9400-53305	82	246	0.009	Y
252-3MGT3-15	9400-43184	84	252	0.009	Y
255-3MGT3-15	9400-53236	85	255	0.009	Y
267-3MGT3-15	9400-53277	89	267	0.010	Y
270-3MGT3-15	9400-53246	90	270	0.010	Y
276-3MGT3-15	9400-53308	92	276	0.010	Y
282-3MGT3-15	9400-53361	94	282	0.004	Y
285-3MGT3-15	9400-53225	95	285	0.010	Y
288-3MGT3-15	9400-53311	96	288	0.010	Y
294-3MGT3-15	9400-53344	98	294	0.011	Y
300-3MGT3-15	9400-53216	100	300	0.011	Y
303-3MGT3-15	9400-43239	101	303	0.003	Y
309-3MGT3-15	9400-53331	103	309	0.011	Y
312-3MGT3-15	9400-53282	104	312	0.011	Y
324-3MGT3-15	9400-53316	108	324	0.012	Y
330-3MGT3-15	9400-53235	110	330	0.012	Y
339-3MGT3-15	9400-53334	113	339	0.012	Y
354-3MGT3-15	9400-53364	118	354	0.003	Y
357-3MGT3-15	9400-43188	119	357	0.016	Y
360-3MGT3-15	9400-53234	120	360	0.013	Y
363-3MGT3-15	9400-43189	121	363	0.013	Y
375-3MGT3-15	9400-53278	125	375	0.014	Y
384-3MGT3-15	9400-43215	128	384	0.014	Y
387-3MGT3-15	9400-53355	129	387	0.008	Y
390-3MGT3-15	9400-53224	130	390	0.014	Y

3MM PITCH - 15 MM WIDE					
Item description	Product Number	Teeth	Pitch Length (mm)	Weight (kg)	Stock
393-3MGT3-15	9400-43216	131	393	0.014	Y
399-3MGT3-15	9400-53367	133	399	0.013	Y
408-3MGT3-15	9400-43191	136	408	0.019	Y
420-3MGT3-15	9400-53240	140	420	0.015	N
426-3MGT3-15	9400-43232	142	426	0.016	Y
450-3MGT3-15	9400-53271	150	450	0.016	Y
456-3MGT3-15	9400-43192	152	456	0.021	Y
480-3MGT3-15	9400-53272	160	480	0.017	Y
489-3MGT3-15	9400-43222	163	489	0.018	Y
495-3MGT3-15	9400-53321	165	495	0.018	Y
501-3MGT3-15	9400-53276	167	501	0.018	Y
510-3MGT3-15	9400-53217	170	510	0.019	Y
513-3MGT3-15	9400-43194	171	513	0.019	Y
522-3MGT3-15	9400-43226	174	522	0.019	Y
537-3MGT3-15	9400-53279	179	537	0.020	Y
540-3MGT3-15	9400-53241	180	540	0.020	Y
552-3MGT3-15	9400-53324	184	552	0.020	Y
561-3MGT3-15	9400-53370	187	561	0.020	Y
564-3MGT3-15	9400-53275	188	564	0.021	Y
570-3MGT3-15	9400-53273	190	570	0.021	Y
582-3MGT3-15	9400-43197	194	582	0.021	Y
588-3MGT3-15	9400-53337	196	588	0.021	Y
600-3MGT3-15	9400-53274	200	600	0.022	Y
621-3MGT3-15	9400-53373	207	621	0.022	Y
630-3MGT3-15	9400-53215	210	630	0.023	Y
657-3MGT3-15	9400-43185	219	657	0.029	Y
750-3MGT3-15	9400-53340	250	750	0.027	Y
777-3MGT3-15	9400-43251	259	777	0.035	Y
840-3MGT3-15	9400-53347	280	840	0.031	Y
849-3MGT3-15	9400-53326	283	849	0.031	Y
897-3MGT3-15	9400-43229	299	897	0.033	Y
1587-3MGT3-15	9400-53287	529	1587	0.058	Y
1692-3MGT3-15	9400-53341	564	1692	0.062	Y



POWERGRIP GT3 BELTS AND SLABS - 2MGT, 3MGT AND 5MGT

3MM PITCH - SLABS						
Item description	Product Number	Teeth	Pitch Length (mm)	Weight (kg)	Stock	Width (inch)
105-3MGT3	9400-43175	35	105	0.130	N	18
120-3MGT3	9400-53020	40	120	0.148	N	18
135-3MGT3	9400-53060	45	135	0.259	N	28
144-3MGT3	9400-53031	48	144	0.178	N	18
150-3MGT3	9400-53026	50	150	0.288	Y	28
165-3MGT3	9400-53027	55	165	0.317	Y	28
174-3MGT3	9400-53051	58	174	0.300	Y	28
180-3MGT3	9400-53011	60	180	0.307	Y	28
186-3MGT3	9400-53032	62	186	0.317	Y	28
192-3MGT3	9400-53033	64	192	0.328	Y	28
195-3MGT3	9400-53012	65	195	0.333	Y	28
204-3MGT3	9400-53034	68	204	0.348	Y	28
210-3MGT3	9400-53018	70	210	0.363	Y	28
216-3MGT3	9400-43178	72	216	0.415	Y	28
225-3MGT3	9400-53013	75	225	0.384	Y	28
231-3MGT3	9400-53035	77	231	0.394	Y	28
234-3MGT3	9400-53053	78	234	0.449	Y	28
240-3MGT3	9400-53000	80	240	0.410	Y	28
243-3MGT3	9400-53036	81	243	0.415	Y	28
246-3MGT3	9400-53037	82	246	0.420	Y	28
252-3MGT3	9400-43183	84	252	0.594	Y	28
255-3MGT3	9400-53001	85	255	0.435	Y	28
267-3MGT3	9400-53029	89	267	0.456	Y	28
270-3MGT3	9400-53021	90	270	0.461	Y	28
276-3MGT3	9400-53038	92	276	0.471	Y	28
282-3MGT3	9400-53054	94	282	0.541	Y	28
285-3MGT3	9400-53002	95	285	0.486	Y	28
288-3MGT3	9400-53039	96	288	0.492	Y	28
294-3MGT3	9400-53048	98	294	0.502	Y	28
300-3MGT3	9400-53003	100	300	0.512	Y	28
303-3MGT3	9400-42244	101	303	0.582	Y	28
309-3MGT3	9400-53043	103	309	0.534	Y	28
312-3MGT3	9400-53025	104	312	0.533	Y	28
324-3MGT3	9400-53040	108	324	0.553	Y	28
330-3MGT3	9400-53016	110	330	0.563	Y	28
339-3MGT3	9400-53044	113	339	0.585	Y	28
354-3MGT3	9400-53055	118	354	0.680	Y	28
357-3MGT3	9400-43170	119	357	0.685	Y	28
360-3MGT3	9400-53014	120	360	0.614	Y	28
363-3MGT3	9400-43167	121	363	0.567	Y	18
375-3MGT3	9400-53030	125	375	0.640	Y	28
384-3MGT3	9400-43173	128	384	0.737	Y	28
387-3MGT3	9400-53052	129	387	0.668	Y	28
390-3MGT3	9400-53004	130	390	0.666	Y	28

3MM PITCH - SLABS						
Item description	Product Number	Teeth	Pitch Length (mm)	Weight (kg)	Stock	Width (inch)
393-3MGT3	9400-43168	131	393	0.490	Y	18
399-3MGT3	9400-53056	133	399	0.766	Y	28
408-3MGT3	9400-43176	136	408	0.783	Y	28
420-3MGT3	9400-53022	140	420	0.717	Y	28
426-3MGT3	9400-43182	142	426	0.818	Y	28
450-3MGT3	9400-53017	150	450	0.768	Y	28
456-3MGT3	9400-43172	152	456	0.875	Y	28
480-3MGT3	9400-53005	160	480	0.819	Y	28
489-3MGT3	9400-43180	163	489	0.939	Y	28
495-3MGT3	9400-53024	165	495	0.845	Y	28
501-3MGT3	9400-53006	167	501	0.855	Y	28
510-3MGT3	9400-53007	170	510	0.871	Y	28
513-3MGT3	9400-43169	171	513	0.789	Y	18
522-3MGT3	9400-43181	174	522	1.002	Y	28
537-3MGT3	9400-53042	179	537	0.917	Y	28
540-3MGT3	9400-53019	180	540	0.922	Y	28
552-3MGT3	9400-53050	184	552	0.942	Y	28
561-3MGT3	9400-53057	187	561	1.077	Y	28
564-3MGT3	9400-53008	188	564	0.963	Y	28
570-3MGT3	9400-53009	190	570	0.973	Y	28
582-3MGT3	9400-43174	194	582	1.117	Y	28
588-3MGT3	9400-53045	196	588	1.015	Y	28
600-3MGT3	9400-53023	200	600	1.024	Y	28
621-3MGT3	9400-53058	207	621	1.192	Y	28
630-3MGT3	9400-53010	210	630	1.075	Y	28
657-3MGT3	9400-43171	219	657	1.261	Y	28
750-3MGT3	9400-53046	250	750	1.295	Y	28
777-3MGT3	9400-43248	259	777	1.492	Y	28
840-3MGT3	9400-53049	280	840	1.434	Y	28
849-3MGT3	9400-53041	283	849	1.449	Y	28
897-3MGT3	9400-43177	299	897	1.722	Y	28
1587-3MGT3	9400-53028	529	1587	1.741	Y	18
1692-3MGT3	9400-53047	564	1692	3.248	Y	28

POWERGRIP GT3

POWERGRIP GT3 BELTS AND SLABS - 2MGT, 3MGT AND 5MGT

5MM PITCH - 9 MM WIDE					
Item description	Product Number	Teeth	Pitch Length (mm)	Weight (kg)	Stock
200-5MGT3-9	9400-55243	40	200	0.008	Y
225-5MGT3-9	9400-55208	45	225	0.009	Y
250-5MGT3-9	9400-55209	50	250	0.009	Y
265-5MGT3-9	9400-55284	53	265	0.010	Y
275-5MGT3-9	9400-55210	55	275	0.010	Y
280-5MGT3-9	9400-45259	56	280	0.011	Y
285-5MGT3-9	9400-45249	57	285	0.011	Y
300-5MGT3-9	9400-55268	60	300	0.011	Y
325-5MGT3-9	9400-55280	65	325	0.012	Y
330-5MGT3-9	9400-55241	66	330	0.013	Y
340-5MGT3-9	9400-55269	68	340	0.013	Y
350-5MGT3-9	9400-55221	70	350	0.013	Y
360-5MGT3-9	9400-55282	72	360	0.014	Y
375-5MGT3-9	9400-55283	75	375	0.014	Y
400-5MGT3-9	9400-55226	80	400	0.015	Y
410-5MGT3-9	9400-55297	82	410	0.016	Y
415-5MGT3-9	9400-45262	83	415	0.016	Y
425-5MGT3-9	9400-55242	85	425	0.016	Y
450-5MGT3-9	9400-55228	90	450	0.016	Y
460-5MGT3-9	9400-55291	92	460	0.017	Y
475-5MGT3-9	9400-55211	95	475	0.018	Y
490-5MGT3-9	9400-45251	98	490	0.019	Y
500-5MGT3-9	9400-55258	100	500	0.019	Y
510-5MGT3-9	9400-45254	102	510	0.019	Y
525-5MGT3-9	9400-55285	105	525	0.020	Y
530-5MGT3-9	9400-55267	106	530	0.020	Y
540-5MGT3-9	9400-55303	108	540	0.021	Y
550-5MGT3-9	9400-55234	110	550	0.021	Y
600-5MGT3-9	9400-55236	120	600	0.023	Y
625-5MGT3-9	9400-45266	125	625	0.024	Y
650-5MGT3-9	9400-55238	130	650	0.025	Y
665-5MGT3-9	9400-45256	133	665	0.025	Y
700-5MGT3-9	9400-55261	140	700	0.027	Y
750-5MGT3-9	9400-55227	150	750	0.028	Y
775-5MGT3-9	9400-55313	155	775	0.029	Y
800-5MGT3-9	9400-55300	160	800	0.030	Y

5MM PITCH - 9 MM WIDE					
Item description	Product Number	Teeth	Pitch Length (mm)	Weight (kg)	Stock
850-5MGT3-9	9400-55229	170	850	0.032	Y
860-5MGT3-9	9400-55302	172	860	0.033	Y
900-5MGT3-9	9400-55237	180	900	0.034	Y
950-5MGT3-9	9400-55263	190	950	0.036	Y
980-5MGT3-9	9400-45265	196	980	0.037	Y
1000-5MGT3-9	9400-55264	200	1000	0.035	Y
1050-5MGT3-9	9400-55307	210	1050	0.040	Y
1150-5MGT3-9	9400-55305	230	1150	0.044	Y
1270-5MGT3-9	9400-55309	254	1270	0.048	Y
1500-5MGT3-9	9400-45269	300	1500	0.056	Y
1755-5MGT3-9	9400-45284	351	1755	0.065	Y
1850-5MGT3-9	9400-45288	364	1850	0.069	Y
2100-5MGT3-9	9400-55286	420	2100	0.080	Y
2440-5MGT3-9	9400-55298	488	2440	0.086	Y

POWERGRIP GT3 BELTS AND SLABS - 2MGT, 3MGT AND 5MGT

5MM PITCH - 15 MM WIDE						5MM PITCH - 25 MM WIDE					
Item description	Product Number	Teeth	Pitch Length (mm)	Weight (kg)	Stock	Item description	Product Number	Teeth	Pitch Length (mm)	Weight (kg)	Stock
200-5MGT3-15	9400-55219	40	200	0.013	Y	200-5MGT3-25	9400-55244	40	200	0.021	Y
225-5MGT3-15	9400-55278	45	225	0.014	Y	225-5MGT3-25	9400-55279	45	225	0.024	Y
250-5MGT3-15	9400-55245	50	250	0.015	Y	250-5MGT3-25	9400-55246	50	250	0.026	Y
265-5MGT3-15	9400-55277	53	265	0.017	Y	265-5MGT3-25	9400-55315	53	265	0.028	Y
275-5MGT3-15	9400-55247	55	275	0.017	Y	275-5MGT3-25	9400-55248	55	275	0.029	Y
280-5MGT3-15	9400-45247	56	280	0.018	Y	280-5MGT3-25	9400-45248	56	280	0.030	Y
285-5MGT3-15	9400-45250	57	285	0.019	Y	285-5MGT3-25	9400-45246	57	285	0.030	Y
300-5MGT3-15	9400-55249	60	300	0.018	Y	300-5MGT3-25	9400-55250	60	300	0.032	Y
325-5MGT3-15	9400-55232	65	325	0.019	Y	325-5MGT3-25	9400-55251	65	325	0.034	Y
330-5MGT3-15	9400-55213	66	330	0.021	Y	330-5MGT3-25	9400-55287	66	330	0.035	Y
340-5MGT3-15	9400-55276	68	340	0.022	Y	340-5MGT3-25	9400-55288	68	340	0.033	Y
350-5MGT3-15	9400-55252	70	350	0.022	Y	350-5MGT3-25	9400-55253	70	350	0.034	Y
360-5MGT3-15	9400-55273	72	360	0.023	Y	360-5MGT3-25	9400-55289	72	360	0.038	Y
375-5MGT3-15	9400-55270	75	375	0.024	Y	375-5MGT3-25	9400-55200	75	375	0.037	Y
400-5MGT3-15	9400-55254	80	400	0.023	Y	400-5MGT3-25	9400-55255	80	400	0.039	Y
410-5MGT3-15	9400-55274	82	410	0.026	Y	410-5MGT3-25	9400-55290	82	410	0.043	Y
415-5MGT3-15	9400-45260	83	415	0.026	Y	415-5MGT3-25	9400-45261	83	415	0.044	Y
425-5MGT3-15	9400-55220	85	425	0.027	Y	425-5MGT3-25	9400-55256	85	425	0.045	Y
450-5MGT3-15	9400-55257	90	450	0.026	Y	450-5MGT3-25	9400-55230	90	450	0.044	Y
460-5MGT3-15	9400-55275	92	460	0.027	Y	460-5MGT3-25	9400-55240	92	460	0.049	Y
475-5MGT3-15	9400-55222	95	475	0.028	Y	475-5MGT3-25	9400-55201	95	475	0.046	Y
490-5MGT3-15	9400-45252	98	490	0.031	Y	490-5MGT3-25	9400-45253	98	490	0.052	Y
500-5MGT3-15	9400-55218	100	500	0.029	Y	500-5MGT3-25	9400-55259	100	500	0.053	Y
510-5MGT3-15	9400-45273	102	510	0.032	Y	510-5MGT3-25	9400-45274	102	510	0.054	Y
525-5MGT3-15	9400-55271	105	525	0.033	Y	525-5MGT3-25	9400-55296	105	525	0.051	Y
530-5MGT3-15	9400-55266	106	530	0.034	Y	530-5MGT3-25	9400-55212	106	530	0.056	Y
540-5MGT3-15	9400-45255	108	540	0.034	Y	540-5MGT3-25	9400-55304	108	540	0.057	Y
550-5MGT3-15	9400-55207	110	550	0.032	Y	550-5MGT3-25	9400-55231	110	550	0.058	Y
600-5MGT3-15	9400-55202	120	600	0.035	Y	600-5MGT3-25	9400-55233	120	600	0.058	Y
625-5MGT3-15	9400-45267	125	625	0.040	Y	625-5MGT3-25	9400-45268	125	625	0.066	Y
650-5MGT3-15	9400-55239	130	650	0.038	Y	650-5MGT3-25	9400-55260	130	650	0.069	Y
665-5MGT3-15	9400-45258	133	665	0.042	Y	665-5MGT3-25	9400-45257	133	665	0.070	Y
700-5MGT3-15	9400-55214	140	700	0.041	Y	700-5MGT3-25	9400-55224	140	700	0.074	Y
750-5MGT3-15	9400-55215	150	750	0.044	Y	750-5MGT3-25	9400-55217	150	750	0.073	Y
775-5MGT3-15	9400-55311	155	775	0.049	Y	775-5MGT3-25	9400-55312	155	775	0.082	Y
800-5MGT3-15	9400-55294	160	800	0.047	Y	800-5MGT3-25	9400-55293	160	800	0.078	Y
850-5MGT3-15	9400-55203	170	850	0.054	Y	850-5MGT3-25	9400-55262	170	850	0.083	Y
860-5MGT3-15	9400-55299	172	860	0.054	Y	860-5MGT3-25	9400-55314	172	860	0.091	Y
900-5MGT3-15	9400-55216	180	900	0.057	Y	900-5MGT3-25	9400-55235	180	900	0.088	Y
950-5MGT3-15	9400-55206	190	950	0.056	Y	950-5MGT3-25	9400-55225	190	950	0.100	Y
980-5MGT3-15	9400-45263	196	980	0.061	Y	980-5MGT3-25	9400-45264	196	980	0.103	Y
1000-5MGT3-15	9400-55205	200	1000	0.063	Y	1000-5MGT3-25	9400-55265	200	1000	0.106	Y
1050-5MGT3-15	9400-55306	210	1050	0.066	Y	1050-5MGT3-25	9400-55295	210	1050	0.102	Y
1150-5MGT3-15	9400-55272	230	1150	0.067	Y	1150-5MGT3-25	9400-55281	230	1150	0.112	Y
1270-5MGT3-15	9400-55301	254	1270	0.080	Y	1270-5MGT3-25	9400-55308	254	1270	0.134	Y
1500-5MGT3-15	9400-45270	300	1500	0.088	Y	1500-5MGT3-25	9400-45271	300	1500	0.155	Y
1755-5MGT3-15	9400-45285	351	1755	0.109	Y	1755-5MGT3-25	9400-45286	351	1755	0.181	Y
1850-5MGT3-15	9400-45289	364	1850	0.114	Y	1850-5MGT3-25	9400-45290	364	1850	0.191	Y
2100-5MGT3-15	9400-55204	420	2100	0.133	Y	2100-5MGT3-25	9400-55223	420	2100	0.222	Y
2440-5MGT3-15	9400-55292	488	2440	0.154	Y	2440-5MGT3-25	9400-55310	488	2440	0.257	Y

POWERGRIP GT3 BELTS AND SLABS - 2MGT, 3MGT AND 5MGT

5MM PITCH - SLABS						
Item description	Product Number	Teeth	Pitch Length (mm)	Weight (kg)	Stock	Width (inch)
200-5MGT3	9400-55028	40	200	0.555	Y	28
225-5MGT3	9400-55022	45	225	0.624	Y	28
250-5MGT3	9400-55023	50	250	0.693	Y	28
265-5MGT3	9400-55013	53	265	0.735	Y	28
275-5MGT3	9400-55024	55	275	0.763	Y	28
280-5MGT3	9400-45238	56	280	0.776	Y	28
285-5MGT3	9400-45237	57	285	0.508	Y	18
300-5MGT3	9400-55021	60	300	0.832	Y	28
325-5MGT3	9400-55014	65	325	0.901	Y	28
330-5MGT3	9400-55015	66	330	0.915	Y	28
340-5MGT3	9400-55016	68	340	0.943	Y	28
350-5MGT3	9400-55027	70	350	0.971	Y	28
360-5MGT3	9400-55017	72	360	0.998	Y	28
375-5MGT3	9400-55007	75	375	1.040	Y	28
400-5MGT3	9400-55018	80	400	1.109	Y	28
410-5MGT3	9400-55019	82	410	1.137	Y	28
415-5MGT3	9400-45242	83	415	1.151	Y	28
425-5MGT3	9400-55029	85	425	1.179	Y	28
450-5MGT3	9400-55020	90	450	1.248	Y	28
460-5MGT3	9400-55010	92	460	1.276	Y	28
475-5MGT3	9400-55011	95	475	1.317	Y	28
490-5MGT3	9400-45239	98	490	1.359	Y	28
500-5MGT3	9400-55000	100	500	1.386	Y	28
510-5MGT3	9400-45240	102	510	1.414	Y	28
525-5MGT3	9400-55034	105	525	1.456	Y	28
530-5MGT3	9400-55001	106	530	1.470	Y	28
540-5MGT3	9400-55038	108	540	1.497	Y	28
550-5MGT3	9400-55002	110	550	1.525	Y	28
600-5MGT3	9400-55032	120	600	1.664	Y	28
625-5MGT3	9400-45244	125	625	1.733	Y	28
650-5MGT3	9400-55003	130	650	1.802	Y	28
665-5MGT3	9400-45241	133	665	1.844	Y	28
700-5MGT3	9400-55004	140	700	1.941	Y	28
750-5MGT3	9400-55005	150	750	2.080	Y	28
775-5MGT3	9400-55037	155	775	2.149	Y	28
800-5MGT3	9400-55030	160	800	1.426	Y	18
850-5MGT3	9400-55012	170	850	1.515	Y	18
860-5MGT3	9400-55036	172	860	2.385	Y	28
900-5MGT3	9400-55008	180	900	1.604	Y	18
950-5MGT3	9400-55025	190	950	1.693	Y	18
980-5MGT3	9400-45243	196	980	2.717	Y	28
1000-5MGT3	9400-55006	200	1000	2.773	Y	28
1050-5MGT3	9400-55031	210	1050	1.871	Y	18
1150-5MGT3	9400-55009	230	1150	2.050	Y	18
1270-5MGT3	9400-55035	254	1270	3.552	Y	28
1500-5MGT3	9400-45245	300	1500	4.159	Y	28
1755-5MGT3	9400-45283	351	1755	3.128	Y	18
1850-5MGT3	9400-45287	364	1850	3.297	Y	18
2100-5MGT3	9400-55026	420	2100	2.703	Y	13
2440-5MGT3	9400-55033	488	2440	3.140	Y	13



POWERGRIP HTD BELTS AND SLABS - 3M, 5M, 8M, 14M AND BELTS 20M

Recommended Sprockets PowerGrip HTD Sprockets

NOTES: Belt pitch is the distance in millimeters between two adjacent tooth centers as measured on the pitch line of the belt. Belt pitch length is the total length (circumference) in millimeters as measured along the pitch line. The theoretical pitch line of a PowerGrip HTD belt lies within the tensile member. PowerGrip HTD part numbers are comprised of pitch length, pitch and width. For example; part number 945-3M-15 denotes a 945 mm pitch length, 3mm pitch and 15mm width. Synchronous pitch length is always a multiple of the belt pitch.

Item description build up: length-pitch-width

3MM PITCH - 6 MM WIDE					
Item description	Product Number	Teeth	Pitch Length (mm)	Weight (kg)	Stock
105-3M-6	9293-40812	35	105	0.002	N
111-3M-6	9293-42696	37	111	0.002	N
120-3M-6	9293-90169	40	120	0.002	N
123-3M-6	9293-40815	41	123	0.002	N
126-3M-6	9293-40818	42	126	0.003	N
129-3M-6	9293-90178	43	129	0.002	N
141-3M-6	9293-40133	47	141	0.003	N
144-3M-6	9293-42797	48	144	0.003	N
150-3M-6	9293-40149	50	150	0.003	Y
156-3M-6	9293-40159	52	156	0.003	Y
159-3M-6	9293-90192	53	159	0.002	Y
165-3M-6	9293-40162	55	165	0.003	Y
168-3M-6	9293-40165	56	168	0.003	Y
171-3M-6	9293-42588	57	171	0.003	N
174-3M-6	9293-40170	58	174	0.003	N
177-3M-6	9293-40182	59	177	0.003	Y
180-3M-6	9293-40190	60	180	0.003	Y
183-3M-6	9293-40826	61	183	0.003	N
186-3M-6	9293-40197	62	186	0.004	N
189-3M-6	9293-40829	63	189	0.004	N
192-3M-6	9293-40832	64	192	0.004	Y
195-3M-6	9293-90217	65	195	0.003	Y
201-3M-6	9293-41139	67	201	0.004	Y
204-3M-6	9293-40208	68	204	0.004	N
210-3M-6	9293-90222	70	210	0.003	Y
213-3M-6	9293-40222	71	213	0.004	N
216-3M-6	9293-42663	72	216	0.004	N
219-3M-6	9293-42666	73	219	0.004	N
222-3M-6	9293-42579	74	222	0.004	N
225-3M-6	9293-90227	75	225	0.003	Y
234-3M-6	9293-42699	78	234	0.004	N
237-3M-6	9293-40246	79	237	0.004	N
243-3M-6	9293-90231	81	243	0.004	Y
246-3M-6	9293-40837	82	246	0.005	Y
249-3M-6	9293-40839	83	249	0.005	Y

3MM PITCH - 6 MM WIDE					
Item description	Product Number	Teeth	Pitch Length (mm)	Weight (kg)	Stock
252-3M-6	9293-90237	84	252	0.004	Y
255-3M-6	9293-40262	85	255	0.005	Y
267-3M-6	9293-40270	89	267	0.005	Y
276-3M-6	9293-40278	92	276	0.005	Y
282-3M-6	9293-90246	94	282	0.005	Y
285-3M-6	9293-40285	95	285	0.005	Y
288-3M-6	9293-90252	96	288	0.004	Y
291-3M-6	9293-40843	97	291	0.005	Y
294-3M-6	9293-40846	98	294	0.005	Y
297-3M-6	9293-42738	99	297	0.005	N
300-3M-6	9293-90260	100	300	0.005	Y
306-3M-6	9293-40848	102	306	0.005	Y
312-3M-6	9293-90265	104	312	0.005	Y
315-3M-6	9293-42670	105	315	0.005	N
318-3M-6	9293-90268	106	318	0.005	Y
330-3M-6	9293-40295	110	330	0.006	Y
333-3M-6	9293-42742	111	333	0.006	Y
336-3M-6	9293-90273	112	336	0.005	Y
339-3M-6	9293-90276	113	339	0.005	N
342-3M-6	9293-42673	114	342	0.006	N
345-3M-6	9293-90279	115	345	0.005	Y
357-3M-6	9293-90282	119	357	0.005	Y
363-3M-6	9293-90285	121	363	0.005	Y
372-3M-6	9293-90288	124	372	0.007	Y
381-3M-6	9293-40850	127	381	0.006	Y
384-3M-6	9293-90291	128	384	0.005	Y
420-3M-6	9293-90076	140	420	0.006	Y
435-3M-6	9293-55066	145	435	0.008	Y
447-3M-6	9293-40331	149	447	0.008	Y
462-3M-6	9293-40339	154	462	0.008	Y
474-3M-6	9293-90298	158	474	0.007	Y
477-3M-6	9293-40350	159	477	0.008	N
480-3M-6	9293-40355	160	480	0.009	Y
486-3M-6	9293-90307	162	486	0.007	N
489-3M-6	9293-42677	163	489	0.008	N

POWERGRIP HTD



POWERGRIP HTD BELTS AND SLABS - 3M, 5M, 8M, 14M AND BELTS 20M

3MM PITCH - 6 MM WIDE					
Item description	Product Number	Teeth	Pitch Length (mm)	Weight (kg)	Stock
501-3M-6	9293-90310	167	501	0.008	Y
513-3M-6	9293-90313	171	513	0.008	N
522-3M-6	9293-40366	174	522	0.009	N
525-3M-6	9293-40370	175	525	0.009	N
531-3M-6	9293-40374	177	531	0.009	N
537-3M-6	9293-40382	179	537	0.009	N
552-3M-6	9293-40853	184	552	0.009	N
558-3M-6	9293-40856	186	558	0.009	N
564-3M-6	9293-90333	188	564	0.007	Y
570-3M-6	9293-40391	190	570	0.009	N
573-3M-6	9293-40859	191	573	0.009	N
582-3M-6	9293-40396	194	582	0.010	Y
591-3M-6	9293-53046	197	591	0.009	N
594-3M-6	9293-90345	198	594	0.008	N
600-3M-6	9293-53969	200	600	0.011	Y
612-3M-6	9293-42679	204	612	0.011	Y
627-3M-6	9293-55014	209	627	0.010	N
633-3M-6	9293-40401	211	633	0.011	Y
645-3M-6	9293-90354	215	645	0.010	Y
648-3M-6	9293-90357	216	648	0.010	N
669-3M-6	9293-90360	223	669	0.010	Y
672-3M-6	9293-40864	224	672	0.011	N
681-3M-6	9293-53049	227	681	0.010	N
711-3M-6	9293-90365	237	711	0.011	Y
720-3M-6	9293-53051	240	720	0.011	Y
735-3M-6	9293-53053	245	735	0.012	N
738-3M-6	9293-40867	246	738	0.012	N
753-3M-6	9293-55068	251	753	0.012	Y
804-3M-6	9293-40406	268	804	0.013	Y
822-3M-6	9293-53056	274	822	0.012	Y
882-3M-6	9293-53870	294	882	0.014	N
945-3M-6	9293-52739	315	945	0.015	Y
981-3M-6	9293-52742	327	981	0.014	N
1002-3M-6	9293-42656	334	1002	0.017	Y
1071-3M-6	9293-40413	357	1071	0.017	N
1080-3M-6	9293-40870	360	1080	0.000	N
1176-3M-6	9293-42658	392	1176	0.020	N
1245-3M-6	9293-90383	415	1245	0.019	Y
1263-3M-6	9293-40873	421	1263	0.022	Y
1500-3M-6	9293-90386	500	1500	0.023	Y
1530-3M-6	9293-90389	510	1530	0.024	Y
1863-3M-6	9293-90163	621	1863	0.029	Y
1926-3M-6	9293-40875	642	1926	0.033	N



POWERGRIP HTD BELTS AND SLABS - 3M, 5M, 8M, 14M AND BELTS 20M

3MM PITCH - 9 MM WIDE					
Item description	Product Number	Teeth	Pitch Length (mm)	Weight (kg)	Stock
105-3M-9	9293-40813	35	105	0.003	N
111-3M-9	9293-42697	37	111	0.003	N
120-3M-9	9293-90170	40	120	0.004	N
123-3M-9	9293-40816	41	123	0.004	N
126-3M-9	9293-40819	42	126	0.004	N
129-3M-9	9293-90179	43	129	0.003	N
141-3M-9	9293-40821	47	141	0.004	N
144-3M-9	9293-42799	48	144	0.004	N
150-3M-9	9293-40152	50	150	0.004	Y
156-3M-9	9293-40823	52	156	0.005	Y
159-3M-9	9293-90193	53	159	0.004	Y
165-3M-9	9293-40163	55	165	0.005	Y
168-3M-9	9293-40166	56	168	0.005	Y
171-3M-9	9293-42661	57	171	0.005	N
174-3M-9	9293-40176	58	174	0.005	N
177-3M-9	9293-40185	59	177	0.005	Y
180-3M-9	9293-40191	60	180	0.005	Y
183-3M-9	9293-40827	61	183	0.005	N
186-3M-9	9293-40198	62	186	0.005	N
189-3M-9	9293-40830	63	189	0.005	N
192-3M-9	9293-40833	64	192	0.005	Y
195-3M-9	9293-90218	65	195	0.004	Y
201-3M-9	9293-42541	67	201	0.005	Y
204-3M-9	9293-40210	68	204	0.005	N
210-3M-9	9293-90223	70	210	0.005	Y
213-3M-9	9293-90226	71	213	0.005	N
216-3M-9	9293-42664	72	216	0.005	N
219-3M-9	9293-42667	73	219	0.005	N
222-3M-9	9293-42570	74	222	0.006	N
225-3M-9	9293-90031	75	225	0.005	Y
234-3M-9	9293-42700	78	234	0.007	N
237-3M-9	9293-40835	79	237	0.006	N
243-3M-9	9293-90232	81	243	0.006	Y
246-3M-9	9293-40250	82	246	0.007	Y
249-3M-9	9293-40251	83	249	0.007	Y
252-3M-9	9293-90158	84	252	0.006	Y
255-3M-9	9293-40264	85	255	0.006	Y
267-3M-9	9293-40272	89	267	0.006	Y
276-3M-9	9293-40280	92	276	0.007	Y
282-3M-9	9293-51498	94	282	0.006	Y
285-3M-9	9293-40841	95	285	0.008	Y
288-3M-9	9293-90156	96	288	0.007	Y
291-3M-9	9293-40844	97	291	0.008	Y
294-3M-9	9293-40847	98	294	0.010	Y

3MM PITCH - 9 MM WIDE					
Item description	Product Number	Teeth	Pitch Length (mm)	Weight (kg)	Stock
297-3M-9	9293-42739	99	297	0.007	N
300-3M-9	9293-90157	100	300	0.007	Y
306-3M-9	9293-40292	102	306	0.008	Y
312-3M-9	9293-90266	104	312	0.007	Y
315-3M-9	9293-42671	105	315	0.009	N
318-3M-9	9293-90018	106	318	0.008	Y
330-3M-9	9293-40296	110	330	0.008	Y
333-3M-9	9293-42740	111	333	0.009	Y
336-3M-9	9293-90274	112	336	0.008	Y
339-3M-9	9293-90277	113	339	0.007	N
342-3M-9	9293-42674	114	342	0.009	N
345-3M-9	9293-90280	115	345	0.008	Y
357-3M-9	9293-90283	119	357	0.008	Y
363-3M-9	9293-90286	121	363	0.007	Y
372-3M-9	9293-90289	124	372	0.008	Y
381-3M-9	9293-40851	127	381	0.010	Y
384-3M-9	9293-90002	128	384	0.009	Y
420-3M-9	9293-90003	140	420	0.010	Y
435-3M-9	9293-53045	145	435	0.009	Y
447-3M-9	9293-40332	149	447	0.011	Y
462-3M-9	9293-40341	154	462	0.012	Y
474-3M-9	9293-90299	158	474	0.011	Y
477-3M-9	9293-40351	159	477	0.012	N
480-3M-9	9293-40356	160	480	0.013	Y
486-3M-9	9293-90308	162	486	0.011	N
489-3M-9	9293-42678	163	489	0.012	N
501-3M-9	9293-90311	167	501	0.012	Y
513-3M-9	9293-90314	171	513	0.012	N
522-3M-9	9293-40367	174	522	0.013	N
525-3M-9	9293-40371	175	525	0.013	N
531-3M-9	9293-40375	177	531	0.013	N
537-3M-9	9293-40383	179	537	0.013	N
552-3M-9	9293-40854	184	552	0.013	N
558-3M-9	9293-40857	186	558	0.014	N
564-3M-9	9293-90334	188	564	0.014	Y
570-3M-9	9293-40392	190	570	0.014	N
573-3M-9	9293-40860	191	573	0.014	N
582-3M-9	9293-40397	194	582	0.015	Y
591-3M-9	9293-53047	197	591	0.014	N
594-3M-9	9293-90346	198	594	0.012	N
600-3M-9	9293-53879	200	600	0.017	Y
612-3M-9	9293-40400	204	612	0.016	Y
627-3M-9	9293-55015	209	627	0.015	N
633-3M-9	9293-40862	211	633	0.017	Y

POWERGRIP HTD



POWERGRIP HTD BELTS AND SLABS - 3M, 5M, 8M, 14M AND BELTS 20M

3MM PITCH - 9 MM WIDE					
Item description	Product Number	Teeth	Pitch Length (mm)	Weight (kg)	Stock
645-3M-9	9293-90355	215	645	0.015	Y
648-3M-9	9293-90358	216	648	0.015	N
669-3M-9	9293-90361	223	669	0.015	Y
672-3M-9	9293-40865	224	672	0.016	N
681-3M-9	9293-51648	227	681	0.015	N
711-3M-9	9293-90366	237	711	0.016	Y
720-3M-9	9293-51652	240	720	0.016	Y
735-3M-9	9293-53054	245	735	0.016	N
738-3M-9	9293-40868	246	738	0.019	N
753-3M-9	9293-55069	251	753	0.018	Y
804-3M-9	9293-40408	268	804	0.020	Y
822-3M-9	9293-90378	274	822	0.017	Y
882-3M-9	9293-52734	294	882	0.020	N
945-3M-9	9293-90421	315	945	0.021	Y
981-3M-9	9293-51660	327	981	0.022	N
1002-3M-9	9293-42592	334	1002	0.026	Y
1071-3M-9	9293-40414	357	1071	0.026	N
1080-3M-9	9293-40871	360	1080	0.026	N
1176-3M-9	9293-42659	392	1176	0.031	N
1245-3M-9	9293-90384	415	1245	0.029	Y
1263-3M-9	9293-40422	421	1263	0.033	Y
1500-3M-9	9293-90387	500	1500	0.035	Y
1530-3M-9	9293-90390	510	1530	0.036	Y
1863-3M-9	9293-90062	621	1863	0.044	Y
1926-3M-9	9293-40876	642	1926	0.047	N



POWERGRIP HTD BELTS AND SLABS - 3M, 5M, 8M, 14M AND BELTS 20M

3MM PITCH - 15 MM WIDE					
Item description	Product Number	Teeth	Pitch Length (mm)	Weight (kg)	Stock
105-3M-15	9293-40814	35	105	0.005	N
111-3M-15	9293-42698	37	111	0.006	N
120-3M-15	9293-90171	40	120	0.005	N
123-3M-15	9293-40817	41	123	0.006	N
126-3M-15	9293-40820	42	126	0.005	N
129-3M-15	9293-90180	43	129	0.005	N
141-3M-15	9293-40822	47	141	0.007	N
144-3M-15	9281-40290	48	144	0.006	N
150-3M-15	9293-40155	50	150	0.007	Y
156-3M-15	9293-42629	52	156	0.008	Y
159-3M-15	9293-90194	53	159	0.006	Y
165-3M-15	9293-40825	55	165	0.008	Y
168-3M-15	9293-40169	56	168	0.008	Y
171-3M-15	9293-42660	57	171	0.007	N
174-3M-15	9293-40178	58	174	0.007	N
177-3M-15	9293-40188	59	177	0.008	Y
180-3M-15	9293-40194	60	180	0.009	Y
183-3M-15	9293-40828	61	183	0.007	N
186-3M-15	9293-40200	62	186	0.008	N
189-3M-15	9293-40831	63	189	0.008	N
192-3M-15	9293-40834	64	192	0.009	Y
195-3M-15	9293-90219	65	195	0.009	Y
201-3M-15	9293-42736	67	201	0.009	Y
204-3M-15	9293-40211	68	204	0.008	N
210-3M-15	9293-90224	70	210	0.008	Y
213-3M-15	9293-40226	71	213	0.009	N
216-3M-15	9293-42662	72	216	0.009	N
219-3M-15	9293-42665	73	219	0.010	N
222-3M-15	9293-42668	74	222	0.010	N
225-3M-15	9293-90029	75	225	0.009	Y
234-3M-15	9293-42701	78	234	0.011	N
237-3M-15	9293-40836	79	237	0.010	N
243-3M-15	9293-90233	81	243	0.010	Y
246-3M-15	9293-40838	82	246	0.011	Y
249-3M-15	9293-40840	83	249	0.012	Y
252-3M-15	9293-90238	84	252	0.010	Y
255-3M-15	9293-40266	85	255	0.010	Y
267-3M-15	9293-40275	89	267	0.012	Y
276-3M-15	9293-40283	92	276	0.013	Y
282-3M-15	9293-90248	94	282	0.011	Y
285-3M-15	9293-40842	95	285	0.013	Y
288-3M-15	9293-90253	96	288	0.011	Y
291-3M-15	9293-40845	97	291	0.012	Y
294-3M-15	9293-40778	98	294	0.013	Y

3MM PITCH - 15 MM WIDE					
Item description	Product Number	Teeth	Pitch Length (mm)	Weight (kg)	Stock
297-3M-15	9293-40290	99	297	0.012	N
300-3M-15	9293-90261	100	300	0.012	Y
306-3M-15	9293-40849	102	306	0.022	Y
312-3M-15	9293-90267	104	312	0.012	Y
315-3M-15	9293-42669	105	315	0.014	N
318-3M-15	9293-90269	106	318	0.013	Y
330-3M-15	9293-40297	110	330	0.015	Y
333-3M-15	9293-42741	111	333	0.015	Y
336-3M-15	9293-90275	112	336	0.013	Y
339-3M-15	9293-90278	113	339	0.013	N
342-3M-15	9293-42672	114	342	0.014	N
345-3M-15	9293-90281	115	345	0.014	Y
357-3M-15	9293-90284	119	357	0.012	Y
363-3M-15	9293-90287	121	363	0.014	Y
372-3M-15	9293-53035	124	372	0.014	Y
381-3M-15	9293-40852	127	381	0.017	Y
384-3M-15	9293-90167	128	384	0.015	Y
420-3M-15	9293-90008	140	420	0.017	Y
435-3M-15	9293-51583	145	435	0.021	Y
447-3M-15	9293-40335	149	447	0.020	Y
462-3M-15	9293-40343	154	462	0.021	Y
474-3M-15	9293-90300	158	474	0.019	Y
477-3M-15	9293-40352	159	477	0.019	N
480-3M-15	9293-40357	160	480	0.021	Y
486-3M-15	9293-90309	162	486	0.019	N
489-3M-15	9293-42676	163	489	0.020	N
501-3M-15	9293-90312	167	501	0.020	Y
513-3M-15	9293-90052	171	513	0.020	N
522-3M-15	9293-40368	174	522	0.021	N
525-3M-15	9293-40372	175	525	0.026	N
531-3M-15	9293-40377	177	531	0.022	N
537-3M-15	9293-40384	179	537	0.022	N
552-3M-15	9293-40855	184	552	0.022	N
558-3M-15	9293-40858	186	558	0.023	N
564-3M-15	9293-90335	188	564	0.022	Y
570-3M-15	9293-40395	190	570	0.023	N
573-3M-15	9293-40861	191	573	0.023	N
582-3M-15	9293-40399	194	582	0.026	Y
591-3M-15	9293-53048	197	591	0.022	N
594-3M-15	9293-90347	198	594	0.023	N
600-3M-15	9293-53305	200	600	0.028	Y
612-3M-15	9293-41160	204	612	0.027	Y
627-3M-15	9293-55013	209	627	0.025	N
633-3M-15	9293-40863	211	633	0.026	Y

POWERGRIP HTD



POWERGRIP HTD BELTS AND SLABS - 3M, 5M, 8M, 14M AND BELTS 20M

3MM PITCH - 15 MM WIDE					
Item description	Product Number	Teeth	Pitch Length (mm)	Weight (kg)	Stock
645-3M-15	9293-90356	215	645	0.025	Y
648-3M-15	9293-90359	216	648	0.022	N
669-3M-15	9293-90168	223	669	0.026	Y
672-3M-15	9293-40866	224	672	0.027	N
681-3M-15	9293-53050	227	681	0.026	N
711-3M-15	9293-90367	237	711	0.029	Y
720-3M-15	9293-53052	240	720	0.027	Y
735-3M-15	9293-53055	245	735	0.028	N
738-3M-15	9293-40869	246	738	0.030	N
753-3M-15	9293-51654	251	753	0.029	Y
804-3M-15	9293-40410	268	804	0.033	Y
822-3M-15	9293-90379	274	822	0.031	Y
882-3M-15	9293-52733	294	882	0.033	N
945-3M-15	9293-55067	315	945	0.036	Y
981-3M-15	9293-53057	327	981	0.040	N
1002-3M-15	9293-42743	334	1002	0.044	Y
1071-3M-15	9293-40415	357	1071	0.047	N
1080-3M-15	9293-40872	360	1080	0.044	N
1176-3M-15	9293-42657	392	1176	0.051	N
1245-3M-15	9293-90385	415	1245	0.049	Y
1263-3M-15	9293-40874	421	1263	0.055	Y
1500-3M-15	9293-90388	500	1500	0.059	Y
1530-3M-15	9293-90391	510	1530	0.060	Y
1863-3M-15	9293-90395	621	1863	0.073	Y
1926-3M-15	9293-40424	642	1926	0.078	N



POWERGRIP HTD BELTS AND SLABS - 3M, 5M, 8M, 14M AND BELTS 20M

3MM PITCH - SLABS						
Item description	Product Number	Teeth	Pitch Length (mm)	Weight (kg)	Stock	Width (inch)
105-3M	9296-40246	35	105	0.185	N	18
111-3M	9296-40698	37	111	0.194	N	18
120-3M	9296-55425	40	120	0.111	N	14
123-3M	9296-40035	41	123	0.211	N	18
126-3M	9296-40036	42	126	0.216	N	18
129-3M	9296-51083	43	129	0.248	N	28
141-3M	9296-40039	47	141	0.237	N	18
144-3M	9296-40040	48	144	0.242	N	18
150-3M	9296-55300	50	150	0.390	Y	28
156-3M	9296-40456	52	156	0.384	Y	28
159-3M	9296-50182	53	159	0.287	Y	28
165-3M	9296-40546	55	165	0.403	Y	28
168-3M	9296-40048	56	168	0.277	Y	18
171-3M	9296-40681	57	171	0.416	N	28
174-3M	9296-40387	58	174	0.422	N	28
177-3M	9296-55295	59	177	0.451	Y	28
180-3M	9296-40513	60	180	0.435	Y	28
183-3M	9296-40549	61	183	0.442	N	28
186-3M	9296-40057	62	186	0.303	N	18
189-3M	9296-40058	63	189	0.308	N	18
192-3M	9296-40059	64	192	0.312	Y	18
195-3M	9296-50184	65	195	0.387	Y	28
201-3M	9296-40288	67	201	0.482	Y	28
204-3M	9296-40535	68	204	0.487	N	28
210-3M	9296-50188	70	210	0.414	Y	28
213-3M	9296-40520	71	213	0.507	N	28
216-3M	9296-40682	72	216	0.514	N	28
219-3M	9296-40683	73	219	0.420	N	28
222-3M	9296-40684	74	222	0.426	N	28
225-3M	9296-50193	75	225	0.397	Y	28
234-3M	9296-40665	78	234	0.553	N	28
237-3M	9296-40067	79	237	0.378	N	18
243-3M	9296-50195	81	243	0.493	Y	28
246-3M	9296-51340	82	246	0.481	Y	28
249-3M	9296-40514	83	249	0.584	Y	28
252-3M	9296-50197	84	252	0.442	Y	28
255-3M	9296-40515	85	255	0.599	Y	28
267-3M	9296-40625	89	267	0.513	Y	28
276-3M	9296-40752	92	276	0.490	Y	28
282-3M	9296-50198	94	282	0.493	Y	28
285-3M	9296-40521	95	285	0.547	Y	28
288-3M	9296-50200	96	288	0.580	Y	28
291-3M	9296-40082	97	291	0.458	Y	18
294-3M	9296-40516	98	294	0.564	Y	28

3MM PITCH - SLABS						
Item description	Product Number	Teeth	Pitch Length (mm)	Weight (kg)	Stock	Width (inch)
297-3M	9296-40253	99	297	0.570	N	28
300-3M	9296-50202	100	300	0.523	Y	28
306-3M	9296-40084	102	306	0.480	Y	18
312-3M	9296-50206	104	312	0.626	Y	28
315-3M	9296-40254	105	315	0.605	N	28
318-3M	9296-50209	106	318	0.553	Y	28
330-3M	9296-40722	110	330	0.633	Y	28
333-3M	9296-40255	111	333	0.639	Y	28
336-3M	9296-50212	112	336	0.647	Y	28
339-3M	9296-50214	113	339	0.588	N	28
342-3M	9296-40685	114	342	0.657	N	28
345-3M	9296-50215	115	345	0.694	Y	28
357-3M	9296-50217	119	357	0.686	Y	28
363-3M	9296-50218	121	363	0.723	Y	28
372-3M	9296-50220	124	372	0.714	Y	28
381-3M	9296-40094	127	381	0.589	Y	18
384-3M	9296-50221	128	384	0.764	Y	28
420-3M	9296-50225	140	420	0.833	Y	28
435-3M	9296-50227	145	435	1.037	Y	28
447-3M	9296-40099	149	447	0.552	Y	18
462-3M	9296-40102	154	462	0.708	Y	18
474-3M	9296-50229	158	474	0.902	Y	28
477-3M	9296-40106	159	477	0.730	N	18
480-3M	9296-40256	160	480	0.921	Y	28
486-3M	9296-50231	162	486	0.925	N	28
489-3M	9296-40687	163	489	0.939	N	28
501-3M	9296-50234	167	501	0.988	Y	28
513-3M	9296-50236	171	513	1.011	N	28
522-3M	9296-40577	174	522	1.002	N	28
525-3M	9296-40111	175	525	0.800	N	18
531-3M	9296-40331	177	531	1.019	N	28
537-3M	9296-40523	179	537	1.031	N	28
552-3M	9296-40247	184	552	0.839	N	18
558-3M	9296-40115	186	558	0.630	N	18
564-3M	9296-50239	188	564	1.108	Y	28
570-3M	9296-40528	190	570	1.094	N	28
573-3M	9296-40688	191	573	1.100	N	28
582-3M	9296-40119	194	582	0.883	Y	18
591-3M	9296-50240	197	591	1.119	N	28
594-3M	9296-50241	198	594	1.014	N	28
600-3M	9296-50242	200	600	1.416	Y	28
612-3M	9296-40121	204	612	0.927	Y	18
627-3M	9296-51098	209	627	1.478	N	28
633-3M	9296-40122	211	633	0.958	Y	18



POWERGRIP HTD BELTS AND SLABS - 3M, 5M, 8M, 14M AND BELTS 20M

3MM PITCH - SLABS						
Item description	Product Number	Teeth	Pitch Length (mm)	Weight (kg)	Stock	Width (inch)
645-3M	9296-50243	215	645	1.099	Y	28
648-3M	9296-50244	216	648	1.105	N	28
669-3M	9296-50245	223	669	1.310	Y	28
672-3M	9296-40123	224	672	1.015	N	18
681-3M	9296-51210	227	681	1.285	N	28
711-3M	9296-50249	237	711	1.390	Y	28
720-3M	9296-50251	240	720	1.357	Y	28
735-3M	9296-50252	245	735	1.411	N	28
738-3M	9296-40124	246	738	1.112	N	18
753-3M	9296-50253	251	753	1.418	Y	28
804-3M	9296-40531	268	804	1.543	Y	28
822-3M	9296-50254	274	822	1.546	Y	28
882-3M	9296-50255	294	882	1.657	N	28
945-3M	9296-50257	315	945	1.774	Y	28
981-3M	9296-50259	327	981	1.840	N	28
1002-3M	9296-40251	334	1002	1.924	Y	28
1071-3M	9296-40127	357	1071	1.322	N	18
1080-3M	9296-40249	360	1080	1.333	N	18
1176-3M	9296-40689	392	1176	2.258	N	28
1245-3M	9296-50260	415	1245	1.424	Y	18
1263-3M	9296-40128	421	1263	1.558	Y	18
1500-3M	9296-50263	500	1500	1.962	Y	18
1530-3M	9296-50268	510	1530	2.001	Y	18
1863-3M	9296-50269	621	1863	2.432	Y	18
1926-3M	9296-40237	642	1926	2.376	N	18



POWERGRIP HTD BELTS AND SLABS - 3M, 5M, 8M, 14M AND BELTS 20M

5MM PITCH - 9 MM WIDE					
Item description	Product Number	Teeth	Pitch Length (mm)	Weight (kg)	Stock
120-5M-9	9293-90087	24	120	0.004	N
180-5M-9	9293-90090	36	180	0.006	Y
225-5M-9	9293-40426	45	225	0.008	Y
255-5M-9	9293-40435	51	255	0.010	Y
265-5M-9	9293-90097	53	265	0.009	Y
270-5M-9	9293-90100	54	270	0.009	Y
275-5M-9	9293-41161	55	275	0.010	N
280-5M-9	9293-40445	56	280	0.010	Y
295-5M-9	9293-40452	59	295	0.012	Y
300-5M-9	9293-40878	60	300	0.012	Y
305-5M-9	9293-31031	61	305	0.011	Y
325-5M-9	9293-90105	65	325	0.011	Y
330-5M-9	9293-90473	66	330	0.011	Y
335-5M-9	9293-40484	67	335	0.012	N
340-5M-9	9293-40489	68	340	0.014	Y
345-5M-9	9293-40495	69	345	0.013	Y
350-5M-9	9293-31035	70	350	0.012	Y
360-5M-9	9293-31036	72	360	0.012	Y
365-5M-9	9293-51402	73	365	0.012	Y
370-5M-9	9293-40516	74	370	0.014	Y
375-5M-9	9293-31038	75	375	0.012	Y
385-5M-9	9293-40526	77	385	0.015	Y
400-5M-9	9293-31040	80	400	0.013	Y
405-5M-9	9293-42690	81	405	0.017	Y
420-5M-9	9293-55016	84	420	0.016	Y
425-5M-9	9293-31043	85	425	0.014	Y
450-5M-9	9293-31045	90	450	0.015	Y
460-5M-9	9293-52483	92	460	0.015	Y
475-5M-9	9293-40556	95	475	0.017	Y
500-5M-9	9293-31050	100	500	0.016	Y
510-5M-9	9293-42693	102	510	0.019	N
520-5M-9	9293-90120	104	520	0.017	Y
525-5M-9	9293-40582	105	525	0.021	Y
535-5M-9	9293-31054	107	535	0.018	Y
550-5M-9	9293-40589	110	550	0.022	Y
560-5M-9	9293-31056	112	560	0.018	Y
565-5M-9	9293-42522	113	565	0.022	Y
575-5M-9	9293-90124	115	575	0.019	Y
580-5M-9	9293-55017	116	580	0.020	Y
600-5M-9	9293-31060	120	600	0.020	Y
610-5M-9	9293-90126	122	610	0.020	Y
615-5M-9	9293-31062	123	615	0.020	Y
635-5M-9	9293-31064	127	635	0.021	Y
640-5M-9	9293-90129	128	640	0.021	Y
645-5M-9	9293-40633	129	645	0.025	Y

5MM PITCH - 9 MM WIDE					
Item description	Product Number	Teeth	Pitch Length (mm)	Weight (kg)	Stock
665-5M-9	9293-31067	133	665	0.022	Y
670-5M-9	9293-90132	134	670	0.022	Y
695-5M-9	9293-55020	139	695	0.027	Y
700-5M-9	9293-90135	140	700	0.023	Y
710-5M-9	9293-53541	142	710	0.023	Y
720-5M-9	9293-53059	144	720	0.023	Y
740-5M-9	9293-31074	148	740	0.024	Y
750-5M-9	9293-40643	150	750	0.029	Y
755-5M-9	9293-90138	151	755	0.025	Y
770-5M-9	9293-40880	154	770	0.029	Y
775-5M-9	9293-52022	155	775	0.025	Y
800-5M-9	9293-31080	160	800	0.025	Y
825-5M-9	9293-40465	165	825	0.031	Y
835-5M-9	9293-31084	167	835	0.027	Y
860-5M-9	9293-40671	172	860	0.033	Y
870-5M-9	9293-42776	174	870	0.031	N
890-5M-9	9293-31089	178	890	0.029	Y
900-5M-9	9293-40680	180	900	0.035	Y
925-5M-9	9293-42599	185	925	0.035	Y
935-5M-9	9293-90144	187	935	0.031	Y
940-5M-9	9293-40883	188	940	0.035	Y
950-5M-9	9293-31095	190	950	0.031	Y
965-5M-9	9293-40886	193	965	0.036	N
980-5M-9	9293-40692	196	980	0.034	Y
1000-5M-9	9293-42617	200	1000	0.038	Y
1025-5M-9	9293-40889	205	1025	0.038	Y
1035-5M-9	9293-90147	207	1035	0.034	Y
1050-5M-9	9293-53940	210	1050	0.033	Y
1100-5M-9	9293-90150	220	1100	0.036	Y
1125-5M-9	9293-40708	225	1125	0.043	Y
1135-5M-9	9293-40891	227	1135	0.042	Y
1175-5M-9	9293-40894	235	1175	0.044	Y
1200-5M-9	9293-90153	240	1200	0.039	Y
1225-5M-9	9293-52128	245	1225	0.039	Y
1270-5M-9	9293-42689	254	1270	0.048	Y
1350-5M-9	9293-41193	270	1350	0.052	Y
1380-5M-9	9293-42702	276	1380	0.051	N
1420-5M-9	9293-40730	284	1420	0.053	Y
1595-5M-9	9293-54016	319	1595	0.051	Y
1690-5M-9	9293-42720	338	1690	0.063	Y
1790-5M-9	9293-40897	358	1790	0.066	Y
1870-5M-9	9293-31187	374	1870	0.062	Y
2100-5M-9	9293-52140	420	2100	0.096	Y
2350-5M-9	9293-52148	470	2350	0.108	Y

POWERGRIP HTD BELTS AND SLABS - 3M, 5M, 8M, 14M AND BELTS 20M

5MM PITCH - 15 MM WIDE					
Item description	Product Number	Teeth	Pitch Length (mm)	Weight (kg)	Stock
120-5M-15	9293-90088	24	120	0.007	N
180-5M-15	9293-90091	36	180	0.010	Y
225-5M-15	9293-40431	45	225	0.016	Y
255-5M-15	9293-40436	51	255	0.015	Y
265-5M-15	9293-90098	53	265	0.015	Y
270-5M-15	9293-90101	54	270	0.015	Y
275-5M-15	9293-41164	55	275	0.016	N
280-5M-15	9293-40447	56	280	0.019	Y
295-5M-15	9293-40453	59	295	0.019	Y
300-5M-15	9293-40879	60	300	0.018	Y
305-5M-15	9293-32031	61	305	0.017	Y
325-5M-15	9293-90047	65	325	0.018	Y
330-5M-15	9293-51730	66	330	0.018	Y
335-5M-15	9293-40485	67	335	0.020	N
340-5M-15	9293-40491	68	340	0.023	Y
345-5M-15	9293-40496	69	345	0.022	Y
350-5M-15	9293-32035	70	350	0.020	Y
360-5M-15	9293-32036	72	360	0.020	Y
365-5M-15	9293-90115	73	365	0.021	Y
370-5M-15	9293-40518	74	370	0.024	Y
375-5M-15	9293-32038	75	375	0.021	Y
385-5M-15	9293-40527	77	385	0.025	Y
400-5M-15	9293-32040	80	400	0.023	Y
405-5M-15	9293-42783	81	405	0.026	Y
420-5M-15	9293-90466	84	420	0.023	Y
425-5M-15	9293-32043	85	425	0.025	Y
450-5M-15	9293-32045	90	450	0.025	Y
460-5M-15	9293-51849	92	460	0.048	Y
475-5M-15	9293-40557	95	475	0.028	Y
500-5M-15	9293-32050	100	500	0.028	Y
510-5M-15	9293-42691	102	510	0.030	N
520-5M-15	9293-52405	104	520	0.029	Y
525-5M-15	9293-40584	105	525	0.034	Y
535-5M-15	9293-32054	107	535	0.030	Y
550-5M-15	9293-40591	110	550	0.032	Y
560-5M-15	9293-32056	112	560	0.030	Y
565-5M-15	9293-42489	113	565	0.033	Y
575-5M-15	9293-90073	115	575	0.032	Y
580-5M-15	9293-55018	116	580	0.037	Y
600-5M-15	9293-32060	120	600	0.034	Y
610-5M-15	9293-90127	122	610	0.034	Y
615-5M-15	9293-32062	123	615	0.034	Y
635-5M-15	9293-32064	127	635	0.035	Y
640-5M-15	9293-90130	128	640	0.036	Y
645-5M-15	9293-40635	129	645	0.038	Y

5MM PITCH - 15 MM WIDE					
Item description	Product Number	Teeth	Pitch Length (mm)	Weight (kg)	Stock
665-5M-15	9293-32067	133	665	0.037	Y
670-5M-15	9293-90133	134	670	0.037	Y
695-5M-15	9293-51989	139	695	0.038	Y
700-5M-15	9293-90136	140	700	0.039	Y
710-5M-15	9293-53552	142	710	0.039	Y
720-5M-15	9293-53060	144	720	0.039	Y
740-5M-15	9293-32074	148	740	0.040	Y
750-5M-15	9293-40647	150	750	0.049	Y
755-5M-15	9293-90139	151	755	0.042	Y
770-5M-15	9293-40881	154	770	0.049	Y
775-5M-15	9293-90486	155	775	0.043	Y
800-5M-15	9293-32080	160	800	0.045	Y
825-5M-15	9293-40666	165	825	0.048	Y
835-5M-15	9293-32084	167	835	0.045	Y
860-5M-15	9293-40672	172	860	0.050	Y
870-5M-15	9293-42598	174	870	0.055	Y
890-5M-15	9293-32089	178	890	0.048	Y
900-5M-15	9293-40681	180	900	0.058	Y
925-5M-15	9293-42694	185	925	0.058	Y
935-5M-15	9293-90145	187	935	0.052	Y
940-5M-15	9293-40884	188	940	0.059	Y
950-5M-15	9293-32095	190	950	0.052	Y
965-5M-15	9293-40887	193	965	0.060	N
980-5M-15	9293-40693	196	980	0.063	Y
1000-5M-15	9293-42596	200	1000	0.063	Y
1025-5M-15	9293-40890	205	1025	0.064	Y
1035-5M-15	9293-90148	207	1035	0.058	Y
1050-5M-15	9293-53542	210	1050	0.057	Y
1100-5M-15	9293-90151	220	1100	0.061	Y
1125-5M-15	9293-40712	225	1125	0.072	Y
1135-5M-15	9293-40892	227	1135	0.070	Y
1175-5M-15	9293-40895	235	1175	0.073	Y
1200-5M-15	9293-90154	240	1200	0.067	Y
1225-5M-15	9293-52130	245	1225	0.068	Y
1270-5M-15	9293-42687	254	1270	0.080	Y
1350-5M-15	9293-40725	270	1350	0.079	Y
1380-5M-15	9293-42703	276	1380	0.085	N
1420-5M-15	9293-40732	284	1420	0.089	Y
1595-5M-15	9293-54020	319	1595	0.086	Y
1690-5M-15	9293-42575	338	1690	0.112	Y
1790-5M-15	9293-40736	358	1790	0.110	Y
1870-5M-15	9293-32187	374	1870	0.103	Y
2100-5M-15	9293-52141	420	2100	0.123	Y
2350-5M-15	9293-52150	470	2350	0.201	Y



POWERGRIP HTD BELTS AND SLABS - 3M, 5M, 8M, 14M AND BELTS 20M

5MM PITCH - 25 MM WIDE					
Item description	Product Number	Teeth	Pitch Length (mm)	Weight (kg)	Stock
120-5M-25	9293-90089	24	120	0.012	N
180-5M-25	9293-90092	36	180	0.018	Y
225-5M-25	9293-40432	45	225	0.026	Y
255-5M-25	9293-40438	51	255	0.029	Y
265-5M-25	9293-90099	53	265	0.027	Y
270-5M-25	9293-90102	54	270	0.026	Y
275-5M-25	9293-41166	55	275	0.027	N
280-5M-25	9293-40449	56	280	0.032	Y
295-5M-25	9293-40877	59	295	0.032	Y
300-5M-25	9293-40458	60	300	0.029	Y
305-5M-25	9293-33031	61	305	0.030	Y
325-5M-25	9293-90106	65	325	0.031	Y
330-5M-25	9293-51728	66	330	0.032	Y
335-5M-25	9293-40486	67	335	0.033	N
340-5M-25	9293-40492	68	340	0.038	Y
345-5M-25	9293-40497	69	345	0.034	Y
350-5M-25	9293-33035	70	350	0.034	Y
360-5M-25	9293-33036	72	360	0.035	Y
365-5M-25	9293-90116	73	365	0.035	Y
370-5M-25	9293-40520	74	370	0.040	Y
375-5M-25	9293-33038	75	375	0.036	Y
385-5M-25	9293-40528	77	385	0.041	Y
400-5M-25	9293-33040	80	400	0.038	Y
405-5M-25	9293-42784	81	405	0.043	Y
420-5M-25	9293-53877	84	420	0.039	Y
425-5M-25	9293-33043	85	425	0.041	Y
450-5M-25	9293-33045	90	450	0.043	Y
460-5M-25	9293-53058	92	460	0.043	Y
475-5M-25	9293-40560	95	475	0.046	Y
500-5M-25	9293-33050	100	500	0.048	Y
510-5M-25	9293-42692	102	510	0.050	N
520-5M-25	9293-90121	104	520	0.050	Y
525-5M-25	9293-40585	105	525	0.057	Y
535-5M-25	9293-33054	107	535	0.051	Y
550-5M-25	9293-40592	110	550	0.058	Y
560-5M-25	9293-33056	112	560	0.052	Y
565-5M-25	9293-42490	113	565	0.055	Y
575-5M-25	9293-90125	115	575	0.055	Y
580-5M-25	9293-55019	116	580	0.062	Y
600-5M-25	9293-33060	120	600	0.057	Y
610-5M-25	9293-90128	122	610	0.058	Y
615-5M-25	9293-33062	123	615	0.060	Y
635-5M-25	9293-33064	127	635	0.060	Y
640-5M-25	9293-90131	128	640	0.061	Y
645-5M-25	9293-40639	129	645	0.063	Y

5MM PITCH - 25 MM WIDE					
Item description	Product Number	Teeth	Pitch Length (mm)	Weight (kg)	Stock
665-5M-25	9293-33067	133	665	0.063	Y
670-5M-25	9293-90134	134	670	0.064	Y
695-5M-25	9293-53996	139	695	0.064	Y
700-5M-25	9293-90137	140	700	0.066	Y
710-5M-25	9293-53644	142	710	0.066	Y
720-5M-25	9293-52008	144	720	0.066	Y
740-5M-25	9293-33074	148	740	0.068	Y
750-5M-25	9293-40648	150	750	0.044	Y
755-5M-25	9293-90140	151	755	0.071	Y
770-5M-25	9293-40882	154	770	0.081	Y
775-5M-25	9293-52023	155	775	0.071	Y
800-5M-25	9293-33080	160	800	0.076	Y
825-5M-25	9293-40667	165	825	0.086	Y
835-5M-25	9293-33084	167	835	0.079	Y
860-5M-25	9293-40673	172	860	0.092	Y
870-5M-25	9293-53686	174	870	0.092	Y
890-5M-25	9293-33089	178	890	0.087	Y
900-5M-25	9293-40685	180	900	0.097	Y
925-5M-25	9293-42695	185	925	0.097	Y
935-5M-25	9293-90146	187	935	0.088	Y
940-5M-25	9293-40885	188	940	0.098	Y
950-5M-25	9293-33095	190	950	0.090	Y
965-5M-25	9293-40888	193	965	0.100	N
980-5M-25	9293-40694	196	980	0.105	Y
1000-5M-25	9293-42597	200	1000	0.105	Y
1025-5M-25	9293-40700	205	1025	0.107	Y
1035-5M-25	9293-90149	207	1035	0.098	Y
1050-5M-25	9293-52997	210	1050	0.097	Y
1100-5M-25	9293-90152	220	1100	0.104	Y
1125-5M-25	9293-40714	225	1125	0.120	Y
1135-5M-25	9293-40893	227	1135	0.117	Y
1175-5M-25	9293-40896	235	1175	0.122	Y
1200-5M-25	9293-90155	240	1200	0.113	Y
1225-5M-25	9293-52129	245	1225	0.115	Y
1270-5M-25	9293-42712	254	1270	0.133	Y
1350-5M-25	9293-40934	270	1350	0.132	Y
1380-5M-25	9293-42704	276	1380	0.142	N
1420-5M-25	9293-40935	284	1420	0.138	Y
1595-5M-25	9293-53982	319	1595	0.146	Y
1690-5M-25	9293-42639	338	1690	0.174	Y
1790-5M-25	9293-40737	358	1790	0.184	Y
1870-5M-25	9293-33187	374	1870	0.180	Y
2100-5M-25	9293-52142	420	2100	0.270	Y
2350-5M-25	9293-33235	470	2350	0.187	Y

POWERGRIP HTD



POWERGRIP HTD BELTS AND SLABS - 3M, 5M, 8M, 14M AND BELTS 20M

5MM PITCH - SLABS						
Item description	Product Number	Teeth	Pitch Length (mm)	Weight (kg)	Stock	Width (inch)
120-5M	9296-55288	24	120	0.145	N	13
180-5M	9296-50274	36	180	0.499	Y	28
225-5M	9296-40130	45	225	0.401	Y	18
255-5M	9296-51515	51	255	0.707	Y	28
265-5M	9296-50924	53	265	0.498	Y	18
270-5M	9296-50275	54	270	0.776	Y	28
275-5M	9296-55301	55	275	0.763	N	28
280-5M	9296-40137	56	280	0.499	Y	18
295-5M	9296-40139	59	295	0.526	Y	18
300-5M	9296-40141	60	300	0.535	Y	18
305-5M	9296-50277	61	305	0.871	Y	28
325-5M	9296-50278	65	325	0.925	Y	28
330-5M	9296-50280	66	330	0.915	Y	28
335-5M	9296-40149	67	335	0.597	N	18
340-5M	9296-40530	68	340	0.943	Y	28
345-5M	9296-40152	69	345	0.615	Y	18
350-5M	9296-50284	70	350	0.992	Y	28
360-5M	9296-50287	72	360	0.993	Y	28
365-5M	9296-50289	73	365	1.032	Y	28
370-5M	9296-40161	74	370	0.659	Y	18
375-5M	9296-50290	75	375	1.059	Y	28
385-5M	9296-40300	77	385	1.068	Y	28
400-5M	9296-50293	80	400	1.127	Y	28
405-5M	9296-40257	81	405	1.123	Y	28
420-5M	9296-50297	84	420	1.151	Y	28
425-5M	9296-50299	85	425	1.194	Y	28
450-5M	9296-50302	90	450	1.262	Y	28
460-5M	9296-50305	92	460	1.256	Y	28
475-5M	9296-40529	95	475	1.317	Y	28
500-5M	9296-50306	100	500	1.397	Y	28
510-5M	9296-40690	102	510	1.414	N	28
520-5M	9296-50309	104	520	1.451	Y	28
525-5M	9296-55359	105	525	1.456	Y	28
535-5M	9296-50312	107	535	1.491	Y	28
550-5M	9296-55366	110	550	1.526	Y	28
560-5M	9296-50314	112	560	1.559	Y	28
565-5M	9296-40573	113	565	1.567	Y	28
575-5M	9296-50315	115	575	1.599	Y	28
580-5M	9296-51653	116	580	1.608	Y	28
600-5M	9296-50317	120	600	1.667	Y	28
610-5M	9296-50320	122	610	1.694	Y	28
615-5M	9296-50322	123	615	1.705	Y	18
635-5M	9296-50325	127	635	1.761	Y	28
640-5M	9296-50328	128	640	1.775	Y	28
645-5M	9296-40183	129	645	1.150	Y	18

5MM PITCH - SLABS						
Item description	Product Number	Teeth	Pitch Length (mm)	Weight (kg)	Stock	Width (inch)
665-5M	9296-50330	133	665	1.795	Y	28
670-5M	9296-50332	134	670	1.856	Y	28
695-5M	9296-50335	139	695	1.874	Y	28
700-5M	9296-50336	140	700	1.937	Y	28
710-5M	9296-50991	142	710	1.914	Y	28
720-5M	9296-50916	144	720	1.940	Y	28
740-5M	9296-50338	148	740	1.993	Y	28
750-5M	9296-40185	150	750	1.337	Y	18
755-5M	9296-50341	151	755	2.085	Y	28
770-5M	9296-40187	154	770	1.372	Y	18
775-5M	9296-50343	155	775	2.139	Y	28
800-5M	9296-50344	160	800	2.207	Y	28
825-5M	9296-40189	165	825	1.470	Y	18
835-5M	9296-50346	167	835	2.301	Y	28
860-5M	9296-40191	172	860	1.533	Y	18
870-5M	9296-40278	174	870	2.412	Y	28
890-5M	9296-50348	178	890	2.450	Y	28
900-5M	9296-40796	180	900	2.496	Y	28
925-5M	9296-40624	185	925	2.565	Y	28
935-5M	9296-50351	187	935	2.571	Y	28
940-5M	9296-40195	188	940	1.675	Y	18
950-5M	9296-50354	190	950	2.612	Y	28
965-5M	9296-40197	193	965	1.720	N	18
980-5M	9296-40199	196	980	1.747	Y	18
1000-5M	9296-40623	200	1000	2.773	Y	28
1025-5M	9296-40229	205	1025	1.827	Y	18
1035-5M	9296-50357	207	1035	2.843	Y	28
1050-5M	9296-50359	210	1050	2.811	Y	28
1100-5M	9296-50360	220	1100	3.019	Y	28
1125-5M	9296-40203	225	1125	2.005	Y	18
1135-5M	9296-40204	227	1135	2.023	Y	18
1175-5M	9296-40206	235	1175	2.094	Y	18
1200-5M	9296-50361	240	1200	3.289	Y	28
1225-5M	9296-50363	245	1225	3.356	Y	28
1270-5M	9296-40679	254	1270	3.522	Y	28
1350-5M	9296-40207	270	1350	2.406	Y	18
1380-5M	9296-40667	276	1380	3.827	N	28
1420-5M	9296-40622	284	1420	3.938	Y	28
1595-5M	9296-51096	319	1595	4.246	Y	28
1690-5M	9296-40610	338	1690	3.012	Y	18
1790-5M	9296-40211	358	1790	3.190	Y	18
1870-5M	9296-50365	374	1870	3.334	Y	18
2100-5M	9296-50367	420	2100	2.703	Y	13
2350-5M	9296-50368	470	2350	3.024	Y	13

POWERGRIP HTD



POWERGRIP HTD BELTS AND SLABS - 3M, 5M, 8M, 14M AND BELTS 20M

8MM PITCH - 20 MM WIDE					
Item description	Product Number	Teeth	Pitch Length (mm)	Weight (kg)	Stock
264-8M-20	9293-40898	33	264	0.034	N
320-8M-20	9293-40000	40	320	0.043	Y
376-8M-20	9293-40003	47	376	0.050	Y
384-8M-20	9293-53061	48	384	0.046	Y
424-8M-20	9293-50007	53	424	0.050	Y
480-8M-20	9293-11048	60	480	0.057	Y
512-8M-20	9293-50046	64	512	0.067	Y
520-8M-20	9293-40907	65	520	0.068	Y
560-8M-20	9293-11056	70	560	0.066	Y
576-8M-20	9293-40013	72	576	0.075	Y
600-8M-20	9293-11060	75	600	0.070	Y
608-8M-20	9293-40028	76	608	0.079	Y
624-8M-20	9293-90915	78	624	0.081	Y
640-8M-20	9293-11064	80	640	0.075	Y
656-8M-20	9293-50158	82	656	0.077	Y
720-8M-20	9293-11072	90	720	0.084	Y
760-8M-20	9293-40919	95	760	0.098	Y
776-8M-20	9293-50216	97	776	0.099	Y
800-8M-20	9293-11080	100	800	0.095	Y
856-8M-20	9293-42426	107	856	0.110	Y
880-8M-20	9293-11088	110	880	0.113	Y
912-8M-20	9293-53068	114	912	0.123	Y
920-8M-20	9293-50330	115	920	0.105	Y
960-8M-20	9293-11096	120	960	0.113	Y
968-8M-20	9293-55035	121	968	0.122	Y
976-8M-20	9293-40922	122	976	0.102	Y
1000-8M-20	9293-90083	125	1000	0.115	Y
1040-8M-20	9293-11104	130	1040	0.122	Y
1064-8M-20	9293-40923	133	1064	0.135	Y
1080-8M-20	9293-40072	135	1080	0.137	Y
1120-8M-20	9293-11112	140	1120	0.131	Y
1128-8M-20	9293-53069	141	1128	0.141	Y
1160-8M-20	9293-50492	145	1160	0.138	Y
1176-8M-20	9293-42681	147	1176	0.160	Y
1200-8M-20	9293-11120	150	1200	0.141	Y
1216-8M-20	9293-53071	152	1216	0.155	Y
1224-8M-20	9293-53075	153	1224	0.139	Y
1256-8M-20	9293-50568	157	1256	0.144	Y
1264-8M-20	9293-53076	158	1264	0.160	Y
1280-8M-20	9293-11128	160	1280	0.150	Y
1304-8M-20	9293-50626	163	1304	0.150	Y
1360-8M-20	9293-50632	170	1360	0.161	Y
1424-8M-20	9293-50656	178	1424	0.169	Y
1432-8M-20	9293-53078	179	1432	0.178	Y

8MM PITCH - 20 MM WIDE					
Item description	Product Number	Teeth	Pitch Length (mm)	Weight (kg)	Stock
1440-8M-20	9293-11144	180	1440	0.169	Y
1512-8M-20	9293-55023	189	1512	0.191	Y
1520-8M-20	9293-40773	190	1520	0.192	Y
1552-8M-20	9293-40926	194	1552	0.196	Y
1584-8M-20	9293-55025	198	1584	0.200	Y
1600-8M-20	9293-11160	200	1600	0.187	Y
1696-8M-20	9293-40928	212	1696	0.214	Y
1728-8M-20	9293-52351	216	1728	0.201	Y
1760-8M-20	9293-11176	220	1760	0.225	Y
1800-8M-20	9293-11180	225	1800	0.212	Y
1880-8M-20	9293-55290	235	1880	0.241	N
1896-8M-20	9293-40929	237	1896	0.239	Y
1904-8M-20	9293-40931	238	1904	0.240	Y
2000-8M-20	9293-11200	250	2000	0.231	Y
2080-8M-20	9293-53081	260	2080	0.289	Y
2200-8M-20	9293-54994	275	2200	0.277	Y
2240-8M-20	9293-50888	280	2240	0.335	Y
2272-8M-20	9293-90449	284	2272	0.353	Y
2400-8M-20	9293-11240	300	2400	0.307	Y
2504-8M-20	9293-55031	313	2504	0.316	N
2600-8M-20	9293-50943	325	2600	0.333	Y
2800-8M-20	9293-11280	350	2800	0.410	Y

POWERGRIP HTD BELTS AND SLABS - 3M, 5M, 8M, 14M AND BELTS 20M

8MM PITCH - 30 MM WIDE					
Item description	Product Number	Teeth	Pitch Length (mm)	Weight (kg)	Stock
264-8M-30	9293-40899	33	264	0.051	N
320-8M-30	9293-40902	40	320	0.065	Y
376-8M-30	9293-40004	47	376	0.075	Y
384-8M-30	9293-53062	48	384	0.071	Y
424-8M-30	9293-90045	53	424	0.078	Y
480-8M-30	9293-12048	60	480	0.084	Y
512-8M-30	9293-50044	64	512	0.093	N
520-8M-30	9293-40908	65	520	0.102	Y
560-8M-30	9293-12046	70	560	0.102	Y
576-8M-30	9293-40911	72	576	0.113	Y
600-8M-30	9293-12060	75	600	0.109	Y
608-8M-30	9293-40030	76	608	0.119	Y
624-8M-30	9293-40916	78	624	0.122	Y
640-8M-30	9293-12064	80	640	0.116	Y
656-8M-30	9293-50161	82	656	0.118	Y
720-8M-30	9293-12072	90	720	0.138	Y
760-8M-30	9293-40033	95	760	0.147	Y
776-8M-30	9293-50215	97	776	0.140	Y
800-8M-30	9293-12080	100	800	0.146	Y
856-8M-30	9293-42650	107	856	0.165	Y
880-8M-30	9293-12088	110	880	0.169	Y
912-8M-30	9293-50325	114	912	0.166	Y
920-8M-30	9293-50331	115	920	0.176	Y
960-8M-30	9293-12096	120	960	0.174	Y
968-8M-30	9293-53933	121	968	0.170	Y
976-8M-30	9293-40041	122	976	0.187	Y
1000-8M-30	9293-90082	125	1000	0.178	Y
1040-8M-30	9293-12104	130	1040	0.189	Y
1064-8M-30	9293-40924	133	1064	0.203	Y
1080-8M-30	9293-40075	135	1080	0.206	Y
1120-8M-30	9293-12112	140	1120	0.203	Y
1128-8M-30	9293-55021	141	1128	0.213	Y
1160-8M-30	9293-50488	145	1160	0.207	Y
1176-8M-30	9293-42682	147	1176	0.224	Y
1200-8M-30	9293-12120	150	1200	0.217	Y
1216-8M-30	9293-53072	152	1216	0.221	Y
1224-8M-30	9293-90448	153	1224	0.217	Y
1256-8M-30	9293-50564	157	1256	0.297	Y
1264-8M-30	9293-53077	158	1264	0.270	Y
1280-8M-30	9293-12128	160	1280	0.226	Y
1304-8M-30	9293-50627	163	1304	0.231	Y
1360-8M-30	9293-50633	170	1360	0.242	Y
1424-8M-30	9293-50654	178	1424	0.253	Y
1432-8M-30	9293-53079	179	1432	0.229	Y

8MM PITCH - 30 MM WIDE					
Item description	Product Number	Teeth	Pitch Length (mm)	Weight (kg)	Stock
1440-8M-30	9293-12144	180	1440	0.253	Y
1512-8M-30	9293-52347	189	1512	0.272	Y
1520-8M-30	9293-40086	190	1520	0.288	Y
1552-8M-30	9293-40094	194	1552	0.294	Y
1584-8M-30	9293-52348	198	1584	0.285	Y
1600-8M-30	9293-12160	200	1600	0.281	Y
1696-8M-30	9293-40098	212	1696	0.321	Y
1728-8M-30	9293-55028	216	1728	0.327	Y
1760-8M-30	9293-12176	220	1760	0.303	Y
1800-8M-30	9293-12180	225	1800	0.319	Y
1880-8M-30	9293-55291	235	1880	0.361	N
1896-8M-30	9293-40930	237	1896	0.359	Y
1904-8M-30	9293-40118	238	1904	0.360	Y
2000-8M-30	9293-12200	250	2000	0.361	Y
2080-8M-30	9293-50881	260	2080	0.399	Y
2200-8M-30	9293-54995	275	2200	0.416	Y
2240-8M-30	9293-50882	280	2240	0.430	Y
2272-8M-30	9293-50892	284	2272	0.436	Y
2400-8M-30	9293-12240	300	2400	0.461	Y
2504-8M-30	9293-55032	313	2504	0.473	N
2600-8M-30	9293-90040	325	2600	0.549	Y
2800-8M-30	9293-12280	350	2800	0.538	Y



POWERGRIP HTD BELTS AND SLABS - 3M, 5M, 8M, 14M AND BELTS 20M

8MM PITCH - 50 MM WIDE					
Item description	Product Number	Teeth	Pitch Length (mm)	Weight (kg)	Stock
264-8M-50	9293-40900	33	264	0.084	N
320-8M-50	9293-40903	40	320	0.108	Y
376-8M-50	9293-40905	47	376	0.141	Y
384-8M-50	9293-53063	48	384	0.122	Y
424-8M-50	9293-50002	53	424	0.125	Y
480-8M-50	9293-13048	60	480	0.151	Y
512-8M-50	9293-53065	64	512	0.160	N
520-8M-50	9293-40909	65	520	0.170	Y
560-8M-50	9293-13056	70	560	0.175	Y
576-8M-50	9293-40015	72	576	0.188	Y
600-8M-50	9293-13060	75	600	0.186	Y
608-8M-50	9293-40913	76	608	0.198	Y
624-8M-50	9293-40917	78	624	0.203	Y
640-8M-50	9293-13064	80	640	0.198	Y
656-8M-50	9293-50164	82	656	0.203	Y
720-8M-50	9293-13072	90	720	0.230	Y
760-8M-50	9293-40920	95	760	0.244	Y
776-8M-50	9293-50217	97	776	0.249	Y
800-8M-50	9293-13080	100	800	0.251	Y
856-8M-50	9293-42685	107	856	0.294	Y
880-8M-50	9293-13088	110	880	0.282	Y
912-8M-50	9293-50324	114	912	0.251	Y
920-8M-50	9293-50332	115	920	0.294	Y
960-8M-50	9293-13096	120	960	0.299	Y
968-8M-50	9293-55036	121	968	0.305	Y
976-8M-50	9293-40044	122	976	0.311	Y
1000-8M-50	9293-50382	125	1000	0.306	Y
1040-8M-50	9293-13104	130	1040	0.324	Y
1064-8M-50	9293-41058	133	1064	0.339	Y
1080-8M-50	9293-40078	135	1080	0.344	Y
1120-8M-50	9293-13112	140	1120	0.348	Y
1128-8M-50	9293-50484	141	1128	0.359	Y
1160-8M-50	9293-50489	145	1160	0.369	Y
1176-8M-50	9293-42683	147	1176	0.401	Y
1200-8M-50	9293-13120	150	1200	0.372	Y
1216-8M-50	9293-53073	152	1216	0.354	Y
1224-8M-50	9293-50554	153	1224	0.335	Y
1256-8M-50	9293-50563	157	1256	0.382	Y
1264-8M-50	9293-50572	158	1264	0.401	Y
1280-8M-50	9293-13128	160	1280	0.380	Y
1304-8M-50	9293-52343	163	1304	0.396	Y
1360-8M-50	9293-50630	170	1360	0.431	Y
1424-8M-50	9293-50659	178	1424	0.450	Y
1432-8M-50	9293-53080	179	1432	0.446	Y

8MM PITCH - 50 MM WIDE					
Item description	Product Number	Teeth	Pitch Length (mm)	Weight (kg)	Stock
1440-8M-50	9293-13144	180	1440	0.427	Y
1512-8M-50	9293-54999	189	1512	0.480	Y
1520-8M-50	9293-40092	190	1520	0.480	Y
1552-8M-50	9293-40095	194	1552	0.490	Y
1584-8M-50	9293-55026	198	1584	0.499	Y
1600-8M-50	9293-13160	200	1600	0.473	Y
1696-8M-50	9293-40774	212	1696	0.536	Y
1728-8M-50	9293-55029	216	1728	0.544	Y
1760-8M-50	9293-13176	220	1760	0.563	Y
1800-8M-50	9293-13180	225	1800	0.567	Y
1880-8M-50	9293-55292	235	1880	0.602	N
1896-8M-50	9293-40776	237	1896	0.598	Y
1904-8M-50	9293-40932	238	1904	0.600	Y
2000-8M-50	9293-13200	250	2000	0.641	Y
2080-8M-50	9293-50878	260	2080	1.495	Y
2200-8M-50	9293-54996	275	2200	0.693	Y
2240-8M-50	9293-50883	280	2240	0.717	Y
2272-8M-50	9293-50893	284	2272	0.858	Y
2400-8M-50	9293-13240	300	2400	0.768	Y
2504-8M-50	9293-55033	313	2504	0.789	N
2600-8M-50	9293-90016	325	2600	0.942	Y
2800-8M-50	9293-13280	350	2800	0.896	Y

POWERGRIP HTD BELTS AND SLABS - 3M, 5M, 8M, 14M AND BELTS 20M

8MM PITCH - 85 MM WIDE					
Item description	Product Number	Teeth	Pitch Length (mm)	Weight (kg)	Stock
264-8M-85	9293-40901	33	264	0.144	N
320-8M-85	9293-40904	40	320	0.184	Y
376-8M-85	9293-40906	47	376	0.213	Y
384-8M-85	9293-53064	48	384	0.207	Y
424-8M-85	9293-53108	53	424	0.209	Y
480-8M-85	9293-14048	60	480	0.264	Y
512-8M-85	9293-53066	64	512	0.281	N
520-8M-85	9293-40910	65	520	0.290	Y
560-8M-85	9293-14056	70	560	0.306	Y
576-8M-85	9293-40912	72	576	0.319	Y
600-8M-85	9293-14060	75	600	0.327	Y
608-8M-85	9293-40914	76	608	0.336	Y
624-8M-85	9293-90918	78	624	0.344	Y
640-8M-85	9293-14064	80	640	0.347	Y
656-8M-85	9293-53067	82	656	0.318	Y
720-8M-85	9293-14072	90	720	0.389	Y
760-8M-85	9293-40921	95	760	0.411	Y
776-8M-85	9293-50218	97	776	0.449	Y
800-8M-85	9293-14080	100	800	0.439	Y
856-8M-85	9293-42686	107	856	0.500	Y
880-8M-85	9293-14088	110	880	0.401	Y
912-8M-85	9293-54978	114	912	0.490	Y
920-8M-85	9293-50333	115	920	0.529	Y
960-8M-85	9293-14096	120	960	0.524	Y
968-8M-85	9293-55037	121	968	0.518	Y
976-8M-85	9293-40045	122	976	0.529	Y
1000-8M-85	9293-50383	125	1000	0.535	Y
1040-8M-85	9293-14104	130	1040	0.567	Y
1064-8M-85	9293-40805	133	1064	0.576	Y
1080-8M-85	9293-40080	135	1080	0.584	Y
1120-8M-85	9293-14112	140	1120	0.609	Y
1128-8M-85	9293-53070	141	1128	0.601	Y
1160-8M-85	9293-50494	145	1160	0.664	Y
1176-8M-85	9293-42684	147	1176	0.681	Y
1200-8M-85	9293-14120	150	1200	0.652	Y
1216-8M-85	9293-53074	152	1216	0.659	Y
1224-8M-85	9293-50553	153	1224	0.652	Y
1256-8M-85	9293-50561	157	1256	0.669	Y
1264-8M-85	9293-55022	158	1264	0.677	Y
1280-8M-85	9293-14128	160	1280	0.657	Y
1304-8M-85	9293-52920	163	1304	0.694	Y
1360-8M-85	9293-50628	170	1360	0.775	Y
1424-8M-85	9293-50651	178	1424	0.811	Y
1432-8M-85	9293-50664	179	1432	0.816	Y

8MM PITCH - 85 MM WIDE					
Item description	Product Number	Teeth	Pitch Length (mm)	Weight (kg)	Stock
1440-8M-85	9293-14144	180	1440	0.737	Y
1512-8M-85	9293-55024	189	1512	0.810	Y
1520-8M-85	9293-40093	190	1520	0.816	Y
1552-8M-85	9293-40927	194	1552	0.835	Y
1584-8M-85	9293-55027	198	1584	0.848	Y
1600-8M-85	9293-14160	200	1600	0.818	Y
1696-8M-85	9293-40101	212	1696	0.911	Y
1728-8M-85	9293-55030	216	1728	0.925	Y
1760-8M-85	9293-14176	220	1760	0.882	Y
1800-8M-85	9293-14180	225	1800	1.021	Y
1880-8M-85	9293-55293	235	1880	1.023	N
1896-8M-85	9293-40117	237	1896	1.016	Y
1904-8M-85	9293-42278	238	1904	1.021	Y
2000-8M-85	9293-14200	250	2000	1.155	Y
2080-8M-85	9293-50880	260	2080	1.323	Y
2200-8M-85	9293-54997	275	2200	1.180	Y
2240-8M-85	9293-50884	280	2240	1.481	Y
2272-8M-85	9293-90436	284	2272	1.502	Y
2400-8M-85	9293-14240	300	2400	1.586	Y
2504-8M-85	9293-55034	313	2504	1.341	N
2600-8M-85	9293-50941	325	2600	1.414	Y
2800-8M-85	9293-14280	350	2800	1.847	Y



POWERGRIP HTD BELTS AND SLABS - 3M, 5M, 8M, 14M AND BELTS 20M

8MM PITCH - SLABS						
Item description	Product Number	Teeth	Pitch Length (mm)	Weight (kg)	Stock	Width (inch)
264-8M	9296-40227	33	264	0.772	N	18
320-8M	9296-40000	40	320	1.456	Y	28
376-8M	9296-40002	47	376	1.100	Y	18
384-8M	9296-51041	48	384	1.736	Y	28
424-8M	9296-50000	53	424	1.883	Y	28
480-8M	9296-50001	60	480	2.116	Y	28
512-8M	9296-50006	64	512	2.249	Y	28
520-8M	9296-40228	65	520	1.521	Y	18
560-8M	9296-50010	70	560	2.449	Y	28
576-8M	9296-40006	72	576	1.685	Y	18
600-8M	9296-50012	75	600	2.616	Y	28
608-8M	9296-40010	76	608	1.778	Y	18
624-8M	9296-40641	78	624	2.839	Y	28
640-8M	9296-50016	80	640	2.783	Y	28
656-8M	9296-50020	82	656	2.849	Y	28
720-8M	9296-50021	90	720	3.116	Y	28
760-8M	9296-40013	95	760	2.233	Y	18
776-8M	9296-50025	97	776	2.246	Y	18
800-8M	9296-50026	100	800	3.514	Y	28
856-8M	9296-55336	107	856	2.505	Y	18
880-8M	9296-50964	110	880	2.574	Y	18
912-8M	9296-50035	114	912	3.990	Y	28
920-8M	9296-51719	115	920	4.122	Y	28
960-8M	9296-50041	120	960	4.193	Y	28
968-8M	9296-51198	121	968	4.405	Y	28
976-8M	9296-40016	122	976	2.855	Y	18
1000-8M	9296-50044	125	1000	4.285	Y	28
1040-8M	9296-50046	130	1040	4.536	Y	28
1064-8M	9296-40020	133	1064	3.112	Y	18
1080-8M	9296-40022	135	1080	3.159	Y	18
1120-8M	9296-50050	140	1120	4.875	Y	28
1128-8M	9296-50054	141	1128	3.231	Y	18
1160-8M	9296-50055	145	1160	3.320	Y	18
1176-8M	9296-40258	147	1176	5.351	Y	28
1200-8M	9296-50058	150	1200	5.215	Y	28
1216-8M	9296-50060	152	1216	3.542	Y	18
1224-8M	9296-50061	153	1224	5.219	Y	28
1256-8M	9296-50063	157	1256	5.352	Y	28
1264-8M	9296-50065	158	1264	3.611	Y	18
1280-8M	9296-50978	160	1280	3.616	Y	18
1304-8M	9296-50072	163	1304	5.552	Y	28
1360-8M	9296-50074	170	1360	3.879	Y	18
1424-8M	9296-50075	178	1424	4.058	Y	18
1432-8M	9296-50076	179	1432	4.080	Y	18

8MM PITCH - SLABS						
Item description	Product Number	Teeth	Pitch Length (mm)	Weight (kg)	Stock	Width (inch)
1440-8M	9296-50077	180	1440	4.058	Y	18
1512-8M	9296-51180	189	1512	6.899	Y	28
1520-8M	9296-40026	190	1520	4.445	Y	18
1552-8M	9296-40028	194	1552	4.539	Y	18
1584-8M	9296-51533	198	1584	7.208	Y	28
1600-8M	9296-50082	200	1600	4.680	Y	18
1696-8M	9296-40029	212	1696	4.960	Y	18
1728-8M	9296-51168	216	1728	7.863	Y	28
1760-8M	9296-50086	220	1760	4.851	Y	18
1800-8M	9296-51560	225	1800	8.065	Y	28
1880-8M	9296-51656	235	1880	5.415	N	18
1896-8M	9296-40033	237	1896	5.545	Y	18
1904-8M	9296-40034	238	1904	5.569	Y	18
2000-8M	9296-55446	250	2000	9.103	Y	28
2080-8M	9296-50099	260	2080	4.393	Y	13
2200-8M	9296-51623	275	2200	4.580	Y	13
2240-8M	9296-50100	280	2240	4.731	Y	13
2272-8M	9296-50102	284	2272	4.798	Y	13
2400-8M	9296-50103	300	2400	5.069	Y	13
2504-8M	9296-51654	313	2504	5.209	N	13
2600-8M	9296-50107	325	2600	5.491	Y	13
2800-8M	9296-50110	350	2800	5.914	Y	13

POWERGRIP HTD BELTS AND SLABS - 3M, 5M, 8M, 14M AND BELTS 20M

14MM PITCH - 40 MM WIDE					
Item description	Product Number	Teeth	Pitch Length (mm)	Weight (kg)	Stock
784-14M-40	9293-55012	56	784	0.308	Y
826-14M-40	9293-53086	59	826	0.342	N
924-14M-40	9293-52358	66	924	0.380	Y
966-14M-40	9293-21096	69	966	0.397	Y
1092-14M-40	9293-90463	78	1092	0.447	Y
1190-14M-40	9293-21119	85	1190	0.486	Y
1400-14M-40	9293-21140	100	1400	0.569	Y
1610-14M-40	9293-21161	115	1610	0.652	Y
1778-14M-40	9293-21177	127	1778	0.690	Y
1890-14M-40	9293-21189	135	1890	0.943	Y
2100-14M-40	9293-21210	150	2100	1.046	Y
2310-14M-40	9293-21231	165	2310	1.021	Y
2450-14M-40	9293-21245	175	2450	0.951	Y
2590-14M-40	9293-21259	185	2590	1.142	Y
2800-14M-40	9293-21280	200	2800	1.086	Y
3150-14M-40	9293-21315	225	3150	1.386	Y
3500-14M-40	9293-21350	250	3500	1.360	Y
3850-14M-40	9293-21385	275	3850	1.689	Y
4004-14M-40	9293-54963	286	4004	1.573	Y
4326-14M-40	9293-21432	309	4326	1.896	Y
4578-14M-40	9293-21457	327	4578	2.006	Y

14MM PITCH - 55 MM WIDE					
Item description	Product Number	Teeth	Pitch Length (mm)	Weight (kg)	Stock
784-14M-55	9293-53082	56	784	0.434	Y
826-14M-55	9293-53087	59	826	0.456	N
924-14M-55	9293-53091	66	924	0.591	Y
966-14M-55	9293-22096	69	966	0.530	Y
1092-14M-55	9293-53517	78	1092	0.596	Y
1190-14M-55	9293-22119	85	1190	0.635	Y
1400-14M-55	9293-22140	100	1400	0.747	Y
1610-14M-55	9293-22161	115	1610	0.859	Y
1778-14M-55	9293-22177	127	1778	1.185	Y
1890-14M-55	9293-22189	135	1890	1.258	Y
2100-14M-55	9293-22210	150	2100	1.395	Y
2310-14M-55	9293-22231	165	2310	1.532	Y
2450-14M-55	9293-22245	175	2450	1.623	Y
2590-14M-55	9293-22259	185	2590	1.714	Y
2800-14M-55	9293-22280	200	2800	1.494	Y
3150-14M-55	9293-22315	225	3150	2.079	Y
3500-14M-55	9293-22350	250	3500	2.306	Y
3850-14M-55	9293-22385	275	3850	2.534	Y
4004-14M-55	9293-51377	286	4004	2.635	Y
4326-14M-55	9293-22432	309	4326	2.844	Y
4578-14M-55	9293-22457	327	4578	3.009	Y

14MM PITCH - 85 MM WIDE					
Item description	Product Number	Teeth	Pitch Length (mm)	Weight (kg)	Stock
784-14M-85	9293-53083	56	784	0.781	Y
826-14M-85	9293-53088	59	826	0.821	N
924-14M-85	9293-52359	66	924	0.914	Y
966-14M-85	9293-23096	69	966	0.954	Y
1092-14M-85	9293-53094	78	1092	1.074	Y
1190-14M-85	9293-23119	85	1190	0.981	Y
1400-14M-85	9293-23140	100	1400	1.154	Y
1610-14M-85	9293-23161	115	1610	1.327	Y
1778-14M-85	9293-23177	127	1778	1.778	Y
1890-14M-85	9293-23189	135	1890	1.558	Y
2100-14M-85	9293-23210	150	2100	1.731	Y
2310-14M-85	9293-23231	165	2310	1.905	Y
2450-14M-85	9293-23245	175	2450	2.434	Y
2590-14M-85	9293-23259	185	2590	2.135	Y
2800-14M-85	9293-23280	200	2800	2.309	Y
3150-14M-85	9293-23315	225	3150	2.579	Y
3500-14M-85	9293-23350	250	3500	2.886	Y
3850-14M-85	9293-23385	275	3850	3.174	Y
4004-14M-85	9293-53096	286	4004	3.301	Y
4326-14M-85	9293-23432	309	4326	3.567	Y
4578-14M-85	9293-23457	327	4578	3.775	Y

14MM PITCH - 115 MM WIDE					
Item description	Product Number	Teeth	Pitch Length (mm)	Weight (kg)	Stock
784-14M-115	9293-53084	56	784	1.457	Y
826-14M-115	9293-53089	59	826	0.921	N
924-14M-115	9293-53092	66	924	1.236	Y
966-14M-115	9293-24096	69	966	1.192	Y
1092-14M-115	9293-55011	78	1092	1.234	Y
1190-14M-115	9293-24119	85	1190	1.945	Y
1400-14M-115	9293-24140	100	1400	1.708	Y
1610-14M-115	9293-24161	115	1610	1.957	Y
1778-14M-115	9293-24177	127	1778	2.370	Y
1890-14M-115	9293-24189	135	1890	2.516	Y
2100-14M-115	9293-24210	150	2100	2.343	Y
2310-14M-115	9293-24231	165	2310	2.577	Y
2450-14M-115	9293-24245	175	2450	3.246	Y
2590-14M-115	9293-24259	185	2590	3.428	Y
2800-14M-115	9293-24280	200	2800	3.123	Y
3150-14M-115	9293-24315	225	3150	4.158	Y
3500-14M-115	9293-24350	250	3500	3.904	Y
3850-14M-115	9293-24385	275	3850	4.295	Y
4004-14M-115	9293-53097	286	4004	4.555	Y
4326-14M-115	9293-24432	309	4326	5.689	Y
4578-14M-115	9293-24457	327	4578	5.107	Y



POWERGRIP HTD BELTS AND SLABS - 3M, 5M, 8M, 14M AND BELTS 20M

14MM PITCH - 170 MM WIDE					
Item description	Product Number	Teeth	Pitch Length (mm)	Weight (kg)	Stock
784-14M-170	9293-53085	56	784	1.953	Y
826-14M-170	9293-53090	59	826	2.053	N
924-14M-170	9293-53093	66	924	1.828	Y
966-14M-170	9293-25096	69	966	2.385	Y
1092-14M-170	9293-53095	78	1092	2.148	Y
1190-14M-170	9293-25119	85	1190	2.917	Y
1400-14M-170	9293-25140	100	1400	3.416	Y
1610-14M-170	9293-25161	115	1610	3.914	Y
1778-14M-170	9293-25177	127	1778	3.556	Y
1890-14M-170	9293-25189	135	1890	3.775	Y
2100-14M-170	9293-25210	150	2100	4.185	Y
2310-14M-170	9293-25231	165	2310	4.596	Y
2450-14M-170	9293-25245	175	2450	4.869	Y
2590-14M-170	9293-25259	185	2590	4.271	Y
2800-14M-170	9293-25280	200	2800	4.617	Y
3150-14M-170	9293-25315	225	3150	5.194	Y
3500-14M-170	9293-25350	250	3500	5.771	Y
3850-14M-170	9293-25385	275	3850	6.349	Y
4004-14M-170	9293-51375	286	4004	7.905	Y
4326-14M-170	9293-25432	309	4326	7.134	Y
4578-14M-170	9293-25457	327	4578	7.549	Y

14MM PITCH - SLABS						
Item description	Product Number	Teeth	Pitch Length (mm)	Weight (kg)	Stock	Width (inch)
784-14M	9296-50114	56	784	3.475	Y	18
826-14M	9296-50388	59	826	4.050	N	18
924-14M	9296-50389	66	924	4.096	Y	18
966-14M	9296-50390	69	966	4.282	Y	18
1092-14M	9296-50115	78	1092	4.481	Y	18
1190-14M	9296-50117	85	1190	5.275	Y	18
1400-14M	9296-20140	100	1400	6.206	Y	18
1610-14M	9296-50124	115	1610	7.137	Y	18
1778-14M	9296-50130	127	1778	5.691	Y	13
1890-14M	9296-50132	135	1890	6.050	Y	13
2100-14M	9296-50138	150	2100	6.722	Y	13
2310-14M	9296-50142	165	2310	7.394	Y	13
2450-14M	9296-50145	175	2450	7.482	Y	13
2590-14M	9296-50148	185	2590	8.291	Y	13
2800-14M	9296-50153	200	2800	8.963	Y	13
3150-14M	9296-50158	225	3150	10.083	Y	13
3500-14M	9296-50161	250	3500	11.203	Y	13
3850-14M	9296-50164	275	3850	12.324	Y	13
4004-14M	9296-50168	286	4004	12.817	Y	13
4326-14M	9296-50170	309	4326	13.848	Y	13
4578-14M	9296-50173	327	4578	14.654	Y	13

20MM PITCH - 115 MM WIDE					
Item description	Product Number	Teeth	Pitch Length (mm)	Weight (kg)	Stock
2000-20M-115	9293-00700	100	2000	10	N
2500-20M-115	9293-00702	125	2500	3.7	N
3400-20M-115	9293-00703	170	3400	5.23	N
3800-20M-115	9293-00704	190	3800	7.525	N
4200-20M-115	9293-00705	210	4200	16.000	N
4600-20M-115	9293-00706	230	4600	7.165	N
5000-20M-115	9293-00707	250	5000	20.000	N
5200-20M-115	9293-00708	260	5200	8.210	N
5400-20M-115	9293-00709	270	5400	7.830	N
5600-20M-115	9293-00710	280	5600	24.000	N
5800-20M-115	9293-00711	290	5800	8.390	Y
6000-20M-115	9293-00775	300	6000	24.000	N
6200-20M-115	9293-00712	310	6200	8.866	N
6400-20M-115	9293-00713	320	6400	9.152	N
6600-20M-115	9293-00714	330	6600	11.794	N

20MM PITCH - 170 MM WIDE					
Item description	Product Number	Teeth	Pitch Length (mm)	Weight (kg)	Stock
2000-20M-170	9293-00715	100	2000	4.443	N
2500-20M-170	9293-00717	125	2500	5.903	Y
3400-20M-170	9293-00718	170	3400	7.8	Y
3800-20M-170	9293-00719	190	3800	8.700	Y
4200-20M-170	9293-00720	210	4200	9.125	N
4600-20M-170	9293-00721	230	4600	9.840	N
5000-20M-170	9293-00722	250	5000	11.095	N
5200-20M-170	9219-02059	260	5200	12.137	N
5400-20M-170	9293-00724	270	5400	12.930	N
5600-20M-170	9293-00725	280	5600	35.470	N
5800-20M-170	9219-02031	290	5800	13.000	N
6000-20M-170	9219-02064	300	6000	35.478	N
6200-20M-170	9293-00727	310	6200	15.876	N
6400-20M-170	9293-00728	320	6400	13.696	N
6600-20M-170	9293-00729	330	6600	13.865	N

POWERGRIP HTD

POWERGRIP HTD BELTS AND SLABS - 3M, 5M, 8M, 14M AND BELTS 20M

20MM PITCH - 230 MM WIDE					
Item description	Product Number	Teeth	Pitch Length (mm)	Weight (kg)	Stock
2000-20M-230	9293-00730	100	2000	5.675	N
2500-20M-230	9293-00732	125	2500	9.072	N
3400-20M-230	9293-00733	170	3400	26	N
3800-20M-230	9293-00734	190	3800	12.701	N
4200-20M-230	9293-00735	210	4200	32.000	N
4600-20M-230	9293-00736	230	4600	14.330	N
5000-20M-230	9293-00737	250	5000	14.815	N
5200-20M-230	9293-00738	260	5200	34.194	N
5400-20M-230	9293-00739	270	5400	19.958	N
5600-20M-230	9293-00740	280	5600	16.352	N
5800-20M-230	9293-00741	290	5800	46.000	N
6000-20M-230	9293-00777	300	6000	17.520	N
6200-20M-230	9293-00742	310	6200	18.680	N
6400-20M-230	9293-00743	320	6400	18.688	N
6600-20M-230	9293-00744	330	6600	19.500	Y

20MM PITCH - 290 MM WIDE					
Item description	Product Number	Teeth	Pitch Length (mm)	Weight (kg)	Stock
2000-20M-290	9293-00745	100	2000	7.46	N
2500-20M-290	9293-00747	125	2500	11.439	N
3400-20M-290	9293-00748	170	3400	14.515	N
3800-20M-290	9219-02051	190	3800	18.980	N
4200-20M-290	9293-00750	210	4200	15.500	Y
4600-20M-290	9293-00751	230	4600	17.158	N
5000-20M-290	9293-00752	250	5000	19.958	N
5200-20M-290	9293-00753	260	5200	19.396	N
5400-20M-290	9293-00754	270	5400	20.142	N
5600-20M-290	9293-00755	280	5600	20.888	N
5800-20M-290	9293-00756	290	5800	23.587	N
6000-20M-290	9293-00778	300	6000	22.380	N
6200-20M-290	9293-00757	310	6200	25.402	N
6400-20M-290	9293-00758	320	6400	23.872	N
6600-20M-290	9293-00759	330	6600	29.030	N

20MM PITCH - 340 MM WIDE					
Item description	Product Number	Teeth	Pitch Length (mm)	Weight (kg)	Stock
2000-20M-340	9293-00760	100	2000	8.44	N
2500-20M-340	9219-02009	125	2500	14.633	N
3400-20M-340	9293-00763	170	3400	15.422	N
3800-20M-340	9293-00764	190	3800	16.036	N
4200-20M-340	9219-02018	210	4200	47.304	N
4600-20M-340	9293-00766	230	4600	19.412	N
5000-20M-340	9293-00767	250	5000	21.200	Y
5200-20M-340	9293-00768	260	5200	20.452	N
5400-20M-340	9293-00769	270	5400	27.216	N
5600-20M-340	9293-00770	280	5600	23.632	N
5800-20M-340	9293-00771	290	5800	60.000	N
6000-20M-340	9293-00779	300	6000	25.320	N
6200-20M-340	9293-00772	310	6200	31.752	N
6400-20M-340	9293-00773	320	6400	27.008	N
6600-20M-340	9293-00774	330	6600	27.852	N



POWERGRIP TIMING BELTS AND SLABS - MXL, XL, L, H, XH, XXH

Recommended Sprockets

PowerGrip Timing Sprockets

NOTES: Gates PowerGrip Timing belts are measured by:

Length - The length of a PowerGrip Timing Belts is shown in the first part of the belt designation. The first number is the pitch length in tenths of an inch. A 300-L-075 has a 30.0" pitch length.

Pitch - The pitch is the distance from center to center of the teeth (in inches). It is shown in the second part of the belt designation by a letter(s). Part number 300-L-075 has a 0.375" or 9.525 mm pitch. The letters correspond to pitches as follows: MXL = Mini Extra Light = 0.080" pitch; XL = Extra Light = 0.200" pitch; L = Light = 0.375" pitch; H = Heavy = 0.500" pitch; XH = Extra Heavy = 0.875" pitch; XXH = Double Extra Heavy = 1.250" pitch.

Width - The width is shown in the last part of the belt designation. Part number 300-L-075 is 0.75" wide. Synchronous pitch length is always a multiple of the belt pitch.

REMARK: MXL belt lengths are shown in 1/100": Partnumber 288-MXL-012: 2.88" length corresponding to 73,152 mm.

Item description build up: length-pitch-width

MXL - 2/25" - 0.080" - 2.032 MM PITCH					
1/8" - 3.2 MM WIDE					
Item description	Product Number	Teeth	Pitch Length (mm)	Weight (kg)	Stock
288-MXL-012	9277-40966	36	73.152	0.001	N
296-MXL-012	9277-42516	37	75.184	0.001	N
320-MXL-012	9277-40973	40	81.280	0.001	N
360-MXL-012	9277-40976	45	91.440	0.001	N
400-MXL-012	9277-40984	50	101.600	0.001	N
424-MXL-012	9277-41637	53	107.696	0.001	N
432-MXL-012	9277-53302	54	109.728	0.001	N
440-MXL-012	9277-40993	55	111.760	0.001	N
448-MXL-012	9277-41640	56	113.792	0.001	N
456-MXL-012	9277-40998	57	115.824	0.001	N
464-MXL-012	9277-41643	58	117.856	0.001	N
472-MXL-012	9277-41645	59	119.888	0.001	N
480-MXL-012	9277-53313	60	121.920	0.001	Y
488-MXL-012	9277-41019	61	123.952	0.001	N
504-MXL-012	9277-41028	63	128.016	0.001	N
520-MXL-012	9277-53925	65	132.080	0.001	N
536-MXL-012	9257-90178	67	136.144	0.001	Y
544-MXL-012	9277-41039	68	138.176	0.001	N
552-MXL-012	9277-41044	69	140.208	0.001	N
560-MXL-012	9277-53329	70	142.240	0.001	N
568-MXL-012	9277-42519	71	144.272	0.001	N
576-MXL-012	9257-90222	72	146.304	0.001	Y
584-MXL-012	9277-41065	73	148.336	0.001	Y
592-MXL-012	9277-54886	74	150.368	0.001	N
600-MXL-012	9277-41571	75	152.400	0.001	Y
608-MXL-012	9277-41077	76	154.432	0.001	Y
616-MXL-012	9277-41091	77	156.464	0.001	N
632-MXL-012	9277-41096	79	160.528	0.001	N
640-MXL-012	9257-11064	80	162.560	0.001	Y
648-MXL-012	9277-53361	81	164.592	0.001	N

MXL - 2/25" - 0.080" - 2.032 MM PITCH					
1/8" - 3.2 MM WIDE					
Item description	Product Number	Teeth	Pitch Length (mm)	Weight (kg)	Stock
656-MXL-012	9277-41112	82	166.624	0.001	Y
664-MXL-012	9277-41122	83	168.656	0.001	N
672-MXL-012	9277-41128	84	170.688	0.001	N
680-MXL-012	9277-41951	85	172.720	0.001	N
696-MXL-012	9277-53363	87	176.784	0.001	N
704-MXL-012	9277-41141	88	178.816	0.001	N
720-MXL-012	9277-41151	90	182.880	0.001	N
736-MXL-012	9277-41158	92	186.944	0.001	N
752-MXL-012	9277-53370	94	191.008	0.012	Y
760-MXL-012	9277-41171	95	193.040	0.001	N
776-MXL-012	9277-53813	97	197.104	0.001	N
800-MXL-012	9277-53380	100	203.200	0.001	N
808-MXL-012	9277-41187	101	205.232	0.001	N
824-MXL-012	9277-41193	103	209.296	0.001	N
840-MXL-012	9277-53393	105	213.360	0.012	Y
848-MXL-012	9277-42520	106	215.392	0.001	N
856-MXL-012	9277-41214	107	217.424	0.001	N
872-MXL-012	9277-41219	109	221.488	0.001	N
880-MXL-012	9277-41225	110	223.520	0.001	Y
912-MXL-012	9277-53401	114	231.648	0.001	N
944-MXL-012	9277-42527	118	239.776	0.001	N
960-MXL-012	9277-53415	120	243.840	0.001	N
976-MXL-012	9277-41264	122	247.904	0.002	N
984-MXL-012	9277-41984	123	249.936	0.002	N
1000-MXL-012	9277-41272	125	254.000	0.002	N
1008-MXL-012	9277-54900	126	256.032	0.001	N
1016-MXL-012	9277-41281	127	258.064	0.002	N
1032-MXL-012	9277-41287	129	262.128	0.002	N
1040-MXL-012	9277-53434	130	264.160	0.001	Y
1056-MXL-012	9277-53440	132	268.224	0.001	Y

POWERGRIP TIMING BELTS AND SLABS - MXL, XL, L, H, XH, XXH

MXL - 2/25" - 0.080" - 2.032 MM PITCH					
1/8" - 3.2 MM WIDE					
Item description	Product Number	Teeth	Pitch Length (mm)	Weight (kg)	Stock
1072-MXL-012	9277-41656	134	272.288	0.002	N
1112-MXL-012	9277-41308	139	282.448	0.002	Y
1120-MXL-012	9277-41315	140	284.480	0.002	Y
1144-MXL-012	9277-54883	143	290.576	0.001	N
1160-MXL-012	9277-53458	145	294.640	0.001	Y
1200-MXL-012	9277-53462	150	304.800	0.001	Y
1240-MXL-012	9277-53931	155	314.960	0.001	N
1264-MXL-012	9277-41339	158	321.056	0.002	N
1280-MXL-012	9277-41342	160	325.120	0.002	Y
1320-MXL-012	9277-41659	165	335.280	0.002	N
1400-MXL-012	9257-11140	175	355.600	0.001	Y
1472-MXL-012	9277-41364	184	373.888	0.002	Y
1520-MXL-012	9277-41373	190	386.080	0.002	N
1560-MXL-012	9277-42474	195	396.240	0.002	N
1600-MXL-012	9277-41384	200	406.400	0.002	Y
1680-MXL-012	9277-41394	210	426.720	0.003	Y
1768-MXL-012	9277-53495	221	449.072	0.001	Y
1800-MXL-012	9277-42380	225	457.200	0.003	N
1832-MXL-012	9277-41413	229	465.328	0.003	N
1856-MXL-012	9277-41821	232	471.424	0.003	N
1880-MXL-012	9277-41425	235	477.520	0.003	Y
1960-MXL-012	9277-42477	245	497.840	0.003	N
1984-MXL-012	9277-41430	248	503.936	0.003	N
1992-MXL-012	9277-53934	249	505.968	0.002	N
2048-MXL-012	9277-41823	256	520.192	0.003	N
2136-MXL-012	9277-42479	267	542.544	0.003	N
2240-MXL-012	9277-41449	280	568.960	0.003	N
2360-MXL-012	9277-42480	295	599.440	0.004	N
2384-MXL-012	9277-41459	298	605.536	0.004	N
2400-MXL-012	9277-41671	300	609.600	0.004	N
2520-MXL-012	9277-41475	315	640.080	0.004	Y
2544-MXL-012	9277-53501	318	646.176	0.002	N
2776-MXL-012	9277-53938	347	705.104	0.004	N
2880-MXL-012	9277-53940	360	731.520	0.003	N
2976-MXL-012	9277-42486	372	755.904	0.004	N
3120-MXL-012	9277-42489	390	792.480	0.003	N
3200-MXL-012	9277-41506	400	812.800	0.003	N
3264-MXL-012	9277-42490	408	829.056	0.005	N
3296-MXL-012	9277-41518	412	837.184	0.005	Y
3360-MXL-012	9277-42492	420	853.440	0.005	N
3392-MXL-012	9277-42494	424	861.568	0.005	N
3472-MXL-012	9277-41693	434	881.888	0.005	N
3800-MXL-012	9277-60499	475	965.200	0.006	N

MXL - 2/25" - 0.080" - 2.032 MM PITCH					
1/8" - 3.2 MM WIDE					
Item description	Product Number	Teeth	Pitch Length (mm)	Weight (kg)	Stock
3904-MXL-012	9277-42500	488	991.616	0.006	N
3984-MXL-012	9277-42503	498	1011.936	0.006	N
4000-MXL-012	9277-42504	500	1016.000	0.006	N
4368-MXL-012	9277-42508	546	1109.472	0.006	N
4736-MXL-012	9277-53942	592	1202.944	0.005	Y



POWERGRIP TIMING BELTS AND SLABS - MXL, XL, L, H, XH, XXH

MXL - 2/25" - 0.080" - 2.032 PITCH					
3/16" - 4.8 MM WIDE					
Item description	Product Number	Teeth	Pitch Length (mm)	Weight (kg)	Stock
288-MXL-019	9277-41634	36	73.152	0.001	N
296-MXL-019	9277-41982	37	75.184	0.001	N
320-MXL-019	9277-41635	40	81.280	0.001	N
360-MXL-019	9277-40978	45	91.440	0.001	N
400-MXL-019	9277-41636	50	101.600	0.001	N
424-MXL-019	9277-42445	53	107.696	0.001	N
432-MXL-019	9277-53308	54	109.728	0.001	N
440-MXL-019	9277-40994	55	111.760	0.001	N
448-MXL-019	9277-41641	56	113.792	0.001	N
456-MXL-019	9277-40997	57	115.824	0.001	N
464-MXL-019	9277-42515	58	117.856	0.001	N
472-MXL-019	9277-41008	59	119.888	0.001	N
480-MXL-019	9257-12048	60	121.920	0.001	Y
488-MXL-019	9277-41020	61	123.952	0.001	N
504-MXL-019	9277-41819	63	128.016	0.001	N
520-MXL-019	9277-53322	65	132.080	0.001	N
536-MXL-019	9277-53326	67	136.144	0.001	Y
544-MXL-019	9277-41040	68	138.176	0.001	N
552-MXL-019	9277-42518	69	140.208	0.001	N
560-MXL-019	9277-53331	70	142.240	0.001	N
568-MXL-019	9277-41050	71	144.272	0.001	N
576-MXL-019	9257-90226	72	146.304	0.002	Y
584-MXL-019	9277-41067	73	148.336	0.001	Y
592-MXL-019	9277-54887	74	150.368	0.001	N
600-MXL-019	9277-41073	75	152.400	0.001	Y
608-MXL-019	9277-41079	76	154.432	0.001	Y
616-MXL-019	9277-41961	77	156.464	0.001	N
632-MXL-019	9277-41097	79	160.528	0.001	N
640-MXL-019	9277-54247	80	162.560	0.001	Y
648-MXL-019	9277-53928	81	164.592	0.001	N
656-MXL-019	9277-41114	82	166.624	0.002	Y
664-MXL-019	9277-41123	83	168.656	0.002	N
672-MXL-019	9277-41649	84	170.688	0.002	N
680-MXL-019	9277-41131	85	172.720	0.002	N
696-MXL-019	9257-90227	87	176.784	0.001	N
704-MXL-019	9277-41143	88	178.816	0.002	N
720-MXL-019	9277-41152	90	182.880	0.002	N
736-MXL-019	9277-41160	92	186.944	0.002	N
752-MXL-019	9277-53371	94	191.008	0.001	Y
760-MXL-019	9277-41172	95	193.040	0.002	N
776-MXL-019	9257-90229	97	197.104	0.001	N
800-MXL-019	9277-53383	100	203.200	0.001	N
808-MXL-019	9277-41188	101	205.232	0.002	N

MXL - 2/25" - 0.080" - 2.032 PITCH					
3/16" - 4.8 MM WIDE					
Item description	Product Number	Teeth	Pitch Length (mm)	Weight (kg)	Stock
824-MXL-019	9277-41194	103	209.296	0.002	N
840-MXL-019	9277-53395	105	213.360	0.002	Y
848-MXL-019	9277-42521	106	215.392	0.002	N
856-MXL-019	9277-41215	107	217.424	0.002	N
872-MXL-019	9277-42526	109	221.488	0.002	N
880-MXL-019	9277-41228	110	223.520	0.002	Y
912-MXL-019	9277-53402	114	231.648	0.001	N
944-MXL-019	9277-41651	118	239.776	0.002	N
960-MXL-019	9257-12096	120	243.840	0.001	N
976-MXL-019	9277-41652	122	247.904	0.002	N
984-MXL-019	9277-41985	123	249.936	0.002	N
1000-MXL-019	9277-42364	125	254.000	0.002	N
1008-MXL-019	9277-53426	126	256.032	0.001	N
1016-MXL-019	9277-42607	127	258.064	0.000	N
1032-MXL-019	9277-42471	129	262.128	0.002	N
1040-MXL-019	9277-53438	130	264.160	0.001	Y
1056-MXL-019	9277-53439	132	268.224	0.001	Y
1072-MXL-019	9277-41307	134	272.288	0.002	N
1112-MXL-019	9277-41309	139	282.448	0.003	Y
1120-MXL-019	9277-41316	140	284.480	0.003	Y
1144-MXL-019	9277-54884	143	290.576	0.002	N
1160-MXL-019	9277-53453	145	294.640	0.002	Y
1200-MXL-019	9277-53467	150	304.800	0.001	Y
1240-MXL-019	9277-53932	155	314.960	0.002	N
1264-MXL-019	9277-42473	158	321.056	0.003	N
1280-MXL-019	9277-41344	160	325.120	0.003	Y
1320-MXL-019	9277-41349	165	335.280	0.003	N
1400-MXL-019	9277-53475	175	355.600	0.002	Y
1472-MXL-019	9277-41365	184	373.888	0.003	Y
1520-MXL-019	9277-41374	190	386.080	0.003	N
1560-MXL-019	9277-42475	195	396.240	0.004	N
1600-MXL-019	9277-41385	200	406.400	0.004	Y
1680-MXL-019	9277-41395	210	426.720	0.004	Y
1768-MXL-019	9277-53485	221	449.072	0.002	Y
1800-MXL-019	9277-41408	225	457.200	0.004	N
1832-MXL-019	9277-41414	229	465.328	0.004	N
1856-MXL-019	9277-41422	232	471.424	0.004	N
1880-MXL-019	9277-42476	235	477.520	0.004	Y
1960-MXL-019	9277-42478	245	497.840	0.004	N
1984-MXL-019	9277-41431	248	503.936	0.004	N
1992-MXL-019	9277-53935	249	505.968	0.003	N
2048-MXL-019	9277-41438	256	520.192	0.005	N
2136-MXL-019	9277-41447	267	542.544	0.003	N

POWERGRIP



POWERGRIP TIMING BELTS AND SLABS - MXL, XL, L, H, XH, XXH

MXL - 2/25" - 0.080" - 2.032 PITCH					
3/16" - 4.8 MM WIDE					
Item description	Product Number	Teeth	Pitch Length (mm)	Weight (kg)	Stock
2240-MXL-019	9277-41450	280	568.960	0.005	N
2360-MXL-019	9277-42481	295	599.440	0.005	N
2384-MXL-019	9277-41461	298	605.536	0.005	N
2400-MXL-019	9277-41672	300	609.600	0.003	N
2520-MXL-019	9277-41477	315	640.080	0.004	Y
2544-MXL-019	9277-53936	318	646.176	0.004	N
2776-MXL-019	9277-53939	347	705.104	0.004	N
2880-MXL-019	9277-53510	360	731.520	0.004	N
2976-MXL-019	9277-42487	372	755.904	0.007	N
3120-MXL-019	9277-42080	390	792.480	0.005	N
3200-MXL-019	9277-41509	400	812.800	0.007	N
3264-MXL-019	9277-42491	408	829.056	0.007	N
3296-MXL-019	9277-41520	412	837.184	0.007	Y
3360-MXL-019	9277-42493	420	853.440	0.007	N
3392-MXL-019	9277-42495	424	861.568	0.008	N
3472-MXL-019	9277-42498	434	881.888	0.008	N
3800-MXL-019	9277-60533	475	965.200	0.008	N
3904-MXL-019	9277-42501	488	991.616	0.006	N
3984-MXL-019	9277-41702	498	1011.936	0.006	N
4000-MXL-019	9277-41704	500	1016.000	0.009	N
4368-MXL-019	9277-41548	546	1109.472	0.006	N
4736-MXL-019	9277-53943	592	1202.944	0.007	Y



POWERGRIP TIMING BELTS AND SLABS - MXL, XL, L, H, XH, XXH

MXL - 2/25" - 0.080" - 2.032 MM PITCH					
1/4" - 6,40 MM WIDE					
Item description	Product Number	Teeth	Pitch Length (mm)	Weight (kg)	Stock
288-MXL-025	9277-40967	36	73.152	0.001	N
296-MXL-025	9277-42517	37	75.184	0.001	N
320-MXL-025	9277-40974	40	81.280	0.001	N
360-MXL-025	9277-40979	45	91.440	0.001	N
400-MXL-025	9277-40985	50	101.600	0.001	N
424-MXL-025	9277-42368	53	107.696	0.001	N
432-MXL-025	9277-53303	54	109.728	0.001	N
440-MXL-025	9277-40995	55	111.760	0.001	N
448-MXL-025	9277-41642	56	113.792	0.002	N
456-MXL-025	9277-41000	57	115.824	0.002	N
464-MXL-025	9277-41004	58	117.856	0.002	N
472-MXL-025	9277-41009	59	119.888	0.001	N
480-MXL-025	9257-13048	60	121.920	0.001	Y
488-MXL-025	9277-41021	61	123.952	0.002	N
504-MXL-025	9277-41029	63	128.016	0.002	N
520-MXL-025	9277-53926	65	132.080	0.001	N
536-MXL-025	9277-53324	67	136.144	0.001	Y
544-MXL-025	9277-41041	68	138.176	0.002	N
552-MXL-025	9277-41647	69	140.208	0.002	N
560-MXL-025	9277-53330	70	142.240	0.001	N
568-MXL-025	9277-41051	71	144.272	0.002	N
576-MXL-025	9277-53927	72	146.304	0.001	Y
584-MXL-025	9277-41068	73	148.336	0.002	Y
592-MXL-025	9277-54888	74	150.368	0.001	N
600-MXL-025	9277-54784	75	152.400	0.001	Y
608-MXL-025	9277-54742	76	154.432	0.022	Y
616-MXL-025	9277-41092	77	156.464	0.002	N
632-MXL-025	9277-41098	79	160.528	0.002	N
640-MXL-025	9277-54249	80	162.560	0.002	Y
648-MXL-025	9277-53929	81	164.592	0.001	N
656-MXL-025	9277-41116	82	166.624	0.002	Y
664-MXL-025	9277-41124	83	168.656	0.002	N
672-MXL-025	9277-41129	84	170.688	0.002	N
680-MXL-025	9277-41820	85	172.720	0.002	N
696-MXL-025	9257-90228	87	176.784	0.001	N
704-MXL-025	9277-41144	88	178.816	0.002	N
720-MXL-025	9277-41153	90	182.880	0.002	N
736-MXL-025	9277-41162	92	186.944	0.002	N
752-MXL-025	9277-53367	94	191.008	0.001	Y
760-MXL-025	9277-41173	95	193.040	0.002	N
776-MXL-025	9277-53372	97	197.104	0.001	N
800-MXL-025	9257-13080	100	203.200	0.001	N
808-MXL-025	9277-41189	101	205.232	0.003	N

MXL - 2/25" - 0.080" - 2.032 MM PITCH					
1/4" - 6,40 MM WIDE					
Item description	Product Number	Teeth	Pitch Length (mm)	Weight (kg)	Stock
824-MXL-025	9277-41195	103	209.296	0.003	N
840-MXL-025	9257-90244	105	213.360	0.003	Y
848-MXL-025	9277-42522	106	215.392	0.003	N
856-MXL-025	9277-41216	107	217.424	0.003	N
872-MXL-025	9277-41221	109	221.488	0.003	N
880-MXL-025	9277-41229	110	223.520	0.003	Y
912-MXL-025	9257-90156	114	231.648	0.001	N
944-MXL-025	9277-41251	118	239.776	0.003	N
960-MXL-025	9277-53410	120	243.840	0.002	N
976-MXL-025	9277-41265	122	247.904	0.003	N
984-MXL-025	9277-41986	123	249.936	0.003	N
1000-MXL-025	9277-41273	125	254.000	0.003	N
1008-MXL-025	9277-53428	126	256.032	0.002	N
1016-MXL-025	9277-41283	127	258.064	0.003	N
1032-MXL-025	9277-42472	129	262.128	0.003	N
1040-MXL-025	9257-13104	130	264.160	0.002	Y
1056-MXL-025	9277-53444	132	268.224	0.002	Y
1072-MXL-025	9277-42362	134	272.288	0.003	N
1112-MXL-025	9277-41310	139	282.448	0.003	Y
1120-MXL-025	9277-41318	140	284.480	0.003	Y
1144-MXL-025	9277-54885	143	290.576	0.002	N
1160-MXL-025	9277-53456	145	294.640	0.002	Y
1200-MXL-025	9257-13120	150	304.800	0.002	Y
1240-MXL-025	9277-53933	155	314.960	0.002	N
1264-MXL-025	9277-41340	158	321.056	0.004	N
1280-MXL-025	9277-41345	160	325.120	0.002	Y
1320-MXL-025	9277-41350	165	335.280	0.004	N
1400-MXL-025	9277-53482	175	355.600	0.003	Y
1472-MXL-025	9277-41366	184	373.888	0.004	Y
1520-MXL-025	9277-41375	190	386.080	0.003	Y
1560-MXL-025	9277-41382	195	396.240	0.003	N
1600-MXL-025	9277-41386	200	406.400	0.005	Y
1680-MXL-025	9277-41396	210	426.720	0.005	Y
1768-MXL-025	9257-90231	221	449.072	0.003	Y
1800-MXL-025	9277-41409	225	457.200	0.005	N
1832-MXL-025	9277-41415	229	465.328	0.005	N
1856-MXL-025	9277-41822	232	471.424	0.004	N
1880-MXL-025	9277-41426	235	477.520	0.004	Y
1960-MXL-025	9277-41665	245	497.840	0.004	N
1984-MXL-025	9277-41432	248	503.936	0.004	N
1992-MXL-025	9277-53499	249	505.968	0.003	N
2048-MXL-025	9277-41439	256	520.192	0.004	N
2136-MXL-025	9277-41667	267	542.544	0.004	N



POWERGRIP TIMING BELTS AND SLABS - MXL, XL, L, H, XH, XXH

MXL - 2/25" - 0.080" - 2.032 MM PITCH					
1/4" - 6,40 MM WIDE					
Item description	Product Number	Teeth	Pitch Length (mm)	Weight (kg)	Stock
2240-MXL-025	9277-41452	280	568.960	0.007	N
2360-MXL-025	9277-42369	295	599.440	0.007	N
2384-MXL-025	9277-41465	298	605.536	0.005	N
2400-MXL-025	9277-41473	300	609.600	0.005	N
2520-MXL-025	9277-41478	315	640.080	0.007	Y
2544-MXL-025	9277-53937	318	646.176	0.195	N
2776-MXL-025	9257-90190	347	705.104	0.005	N
2880-MXL-025	9277-53509	360	731.520	0.006	N
2976-MXL-025	9277-42488	372	755.904	0.009	N
3120-MXL-025	9277-41504	390	792.480	0.009	N
3200-MXL-025	9277-41510	400	812.800	0.009	N
3264-MXL-025	9277-41683	408	829.056	0.006	N
3296-MXL-025	9277-41521	412	837.184	0.010	Y
3360-MXL-025	9277-41686	420	853.440	0.007	N
3392-MXL-025	9277-42331	424	861.568	0.010	N
3472-MXL-025	9277-41824	434	881.888	0.010	N
3800-MXL-025	9277-60534	475	965.200	0.008	N
3904-MXL-025	9277-42502	488	991.616	0.012	N
3984-MXL-025	9277-41541	498	1011.936	0.008	N
4000-MXL-025	9277-42505	500	1016.000	0.008	N
4368-MXL-025	9277-41549	546	1109.472	0.008	N
4736-MXL-025	9277-53521	592	1202.944	0.010	Y



POWERGRIP TIMING BELTS AND SLABS - MXL, XL, L, H, XH, XXH

MXL - 2/25" - 0.080" - 2.032 MM PITCH						
SLABS						
Item description	Product Number	Teeth	Pitch Length (mm)	Weight (kg)	Stock	Width (inch)
288-MXL	9277-40972	36	73.152	0.02	N	15
296-MXL	9254-40674	37	75.184	0.04	N	18
320-MXL	9254-40202	40	81.280	0.05	N	18
360-MXL	9254-40203	45	91.440	0.05	N	18
400-MXL	9254-40204	50	101.600	0.06	N	18
424-MXL	9254-40205	53	107.696	0.06	N	18
432-MXL	9254-52929	54	109.728	0.06	N	18
440-MXL	9254-40207	55	111.760	0.06	N	18
448-MXL	9254-40208	56	113.792	0.06	N	18
456-MXL	9254-40209	57	115.824	0.06	N	18
464-MXL	9254-40210	58	117.856	0.07	N	18
472-MXL	9254-40211	59	119.888	0.07	N	18
480-MXL	9254-52930	60	121.920	0.07	Y	18
488-MXL	9254-40213	61	123.952	0.07	N	18
504-MXL	9254-53758	63	128.016	0.00	N	14
520-MXL	9254-52931	65	132.080	0.07	N	18
536-MXL	9254-40216	67	136.144	0.08	Y	18
544-MXL	9254-40217	68	138.176	0.08	N	18
552-MXL	9254-40218	69	140.208	0.08	N	18
560-MXL	9254-52933	70	142.240	0.08	N	18
568-MXL	9254-40220	71	144.272	0.07	N	18
576-MXL	9254-53546	72	146.304	0.13	Y	28
584-MXL	9254-40223	73	148.336	0.08	Y	18
592-MXL	9254-53675	74	150.368	0.13	N	28
600-MXL	9254-40627	75	152.400	0.13	Y	28
608-MXL	9254-53560	76	154.432	0.13	Y	28
616-MXL	9254-40226	77	156.464	0.09	N	18
632-MXL	9254-40227	79	160.528	0.09	N	18
640-MXL	9254-40573	80	162.560	0.14	Y	28
648-MXL	9254-52937	81	164.592	0.09	N	18
656-MXL	9254-40427	82	166.624	0.14	Y	28
664-MXL	9254-53669	83	168.656	0.14	N	28
672-MXL	9254-40232	84	170.688	0.09	N	18
680-MXL	9254-40233	85	172.720	0.15	N	28
696-MXL	9254-53571	87	176.784	0.10	N	18
704-MXL	9254-40235	88	178.816	0.10	N	18
720-MXL	9254-53737	90	182.880	0.16	N	28
808-MXL	9254-53743	90	205.232	0.18	N	28
736-MXL	9254-40237	92	186.944	0.10	N	18
752-MXL	9254-52939	94	191.008	0.11	Y	18
760-MXL	9254-40752	95	193.040	0.17	N	28
776-MXL	9254-52941	97	197.104	0.11	N	18
800-MXL	9254-52943	100	203.200	0.17	N	28

MXL - 2/25" - 0.080" - 2.032 MM PITCH						
SLABS						
Item description	Product Number	Teeth	Pitch Length (mm)	Weight (kg)	Stock	Width (inch)
824-MXL	9254-40568	103	209.296	0.18	N	28
840-MXL	9254-40649	105	213.360	0.18	Y	28
848-MXL	9254-40605	106	215.392	0.18	N	28
856-MXL	9254-40245	107	217.424	0.12	N	18
872-MXL	9254-40246	109	221.488	0.12	N	18
880-MXL	9254-40569	110	223.520	0.19	Y	28
912-MXL	9254-52945	114	231.648	0.20	N	28
944-MXL	9254-40249	118	239.776	0.13	N	18
960-MXL	9254-53558	120	243.840	0.21	N	28
976-MXL	9254-40251	122	247.904	0.14	N	18
984-MXL	9254-40253	123	249.936	0.14	N	18
1000-MXL	9254-40254	125	254.000	0.14	N	18
1008-MXL	9254-53716	126	256.032	0.22	N	28
1016-MXL	9254-40256	127	258.064	0.14	N	18
1032-MXL	9254-40341	129	262.128	0.22	N	28
1040-MXL	9254-52950	130	264.160	0.15	Y	18
1056-MXL	9254-52979	132	268.224	0.23	Y	28
1072-MXL	9254-40261	134	272.288	0.15	N	18
1112-MXL	9254-40262	139	282.448	0.16	Y	18
1120-MXL	9254-40263	140	284.480	0.16	Y	18
1144-MXL	9254-53674	143	290.576	0.25	N	28
1160-MXL	9254-52953	145	294.640	0.25	Y	28
1200-MXL	9254-52954	150	304.800	0.26	Y	28
1240-MXL	9254-52955	155	314.960	0.22	N	18
1264-MXL	9254-40267	158	321.056	0.18	N	18
1280-MXL	9254-40570	160	325.120	0.28	Y	28
1320-MXL	9254-40269	165	335.280	0.18	N	18
1400-MXL	9254-40343	175	355.600	0.30	Y	28
1472-MXL	9254-53736	184	373.888	0.32	Y	28
1520-MXL	9254-53740	190	386.080	0.33	N	28
1560-MXL	9254-40679	195	396.240	0.34	N	28
1600-MXL	9254-40342	200	406.400	0.35	Y	28
1680-MXL	9254-40275	210	426.720	0.23	Y	18
1768-MXL	9254-40276	221	449.072	0.25	Y	18
1800-MXL	9254-40277	225	457.200	0.25	N	18
1832-MXL	9254-53732	229	465.328	0.40	N	28
1856-MXL	9254-40280	232	471.424	0.26	N	18
1880-MXL	9254-40281	235	477.520	0.26	Y	18
1960-MXL	9254-40282	245	497.840	0.27	N	18
1984-MXL	9254-40283	248	503.936	0.28	N	18
1992-MXL	9254-52960	249	505.968	0.25	N	13
2048-MXL	9254-40284	256	520.192	0.29	N	18
2136-MXL	9254-53734	267	542.544	0.46	N	28



POWERGRIP TIMING BELTS AND SLABS - MXL, XL, L, H, XH, XXH

MXL - 2/25" - 0.080" - 2.032 MM PITCH						
SLABS						
Item description	Product Number	Teeth	Pitch Length (mm)	Weight (kg)	Stock	Width (inch)
2240-MXL	9254-40286	280	568.960	0.31	N	18
2360-MXL	9254-40287	295	599.440	0.57	N	18
2384-MXL	9254-40572	298	605.536	0.52	N	28
2400-MXL	9254-40675	300	609.600	0.52	N	28
2520-MXL	9254-40290	315	640.080	0.35	Y	18
2544-MXL	9254-53226	318	646.176	0.35	N	18
2776-MXL	9254-40467	347	705.104	0.60	N	28
2880-MXL	9254-53442	360	731.520	0.40	N	18
2976-MXL	9254-40295	372	755.904	0.42	N	18
3120-MXL	9254-40296	390	792.480	0.44	N	18
3200-MXL	9254-40297	400	812.800	0.45	N	18
3264-MXL	9254-40325	408	829.056	0.46	N	18
3296-MXL	9254-40299	412	837.184	0.46	Y	18
3360-MXL	9254-40300	420	853.440	0.47	N	18
3392-MXL	9254-40302	424	861.568	0.47	N	18
3472-MXL	9254-40304	434	881.888	0.48	N	18
3800-MXL	9254-60038	475	965.200	0.82	N	28
3904-MXL	9254-40307	488	991.616	0.54	N	18
3984-MXL	9254-40308	498	1011.936	0.56	N	18
4000-MXL	9254-40309	500	1016.000	0.56	N	18
4368-MXL	9254-40311	546	1109.472	0.61	N	18
4736-MXL	9254-52963	592	1202.944	0.66	Y	18



POWERGRIP TIMING BELTS AND SLABS - MXL, XL, L, H, XH, XXH

XL - 1/5" - 0.200" - 5.08 MM PITCH					
1/4" - 6.40 MM WIDE					
Item description	Product Number	Teeth	Pitch Length (mm)	Weight (kg)	Stock
46-XL-025	9277-42588	23	116.840	0.001	N
50-XL-025	9257-01121	25	127.000	0.001	N
58-XL-025	9277-53810	29	147.320	0.002	N
60-XL-025	9257-21006	30	152.400	0.002	Y
66-XL-025	9277-42595	33	167.640	0.000	N
70-XL-025	9257-21007	35	177.800	0.002	Y
76-XL-025	9277-40453	38	193.040	0.003	N
80-XL-025	9257-21008	40	203.200	0.002	Y
84-XL-025	9277-53973	42	213.360	0.003	N
86-XL-025	9277-42599	43	218.440	0.003	N
88-XL-025	9277-42600	44	223.520	0.004	N
90-XL-025	9257-21009	45	228.600	0.003	Y
92-XL-025	9277-53975	46	233.680	0.003	N
94-XL-025	9277-42602	47	238.760	0.004	N
96-XL-025	9277-42604	48	243.840	0.003	N
98-XL-025	9277-53945	49	248.920	0.003	N
100-XL-025	9257-21010	50	254.000	0.003	Y
102-XL-025	9277-53947	51	259.080	0.003	N
108-XL-025	9277-40505	54	274.320	0.005	N
110-XL-025	9257-21011	55	279.400	0.003	Y
112-XL-025	9277-40524	56	284.480	0.005	N
114-XL-025	9277-40531	57	289.560	0.005	N
116-XL-025	9277-41773	58	294.640	0.005	N
118-XL-025	9277-42530	59	299.720	0.005	N
120-XL-025	9257-21012	60	304.800	0.004	Y
122-XL-025	9277-53950	61	309.880	0.004	N
124-XL-025	9277-53952	62	314.960	0.004	N
126-XL-025	9277-53954	63	320.040	0.004	N
128-XL-025	9277-53956	64	325.120	0.004	Y
130-XL-025	9257-21013	65	330.200	0.004	Y
132-XL-025	9277-40573	66	335.280	0.006	N
134-XL-025	9277-42533	67	340.360	0.006	N
136-XL-025	9277-40578	68	345.440	0.006	Y
138-XL-025	9277-53959	69	350.520	0.004	N
140-XL-025	9257-21014	70	355.600	0.004	Y
142-XL-025	9277-53962	71	360.680	0.005	N
144-XL-025	9277-52271	72	365.760	0.005	N
146-XL-025	9277-52276	73	370.840	0.005	N
148-XL-025	9277-52280	74	375.920	0.005	N
150-XL-025	9257-21015	75	381.000	0.005	Y
154-XL-025	9277-52321	77	391.160	0.006	N
156-XL-025	9277-53976	78	396.240	0.005	Y
158-XL-025	9277-53981	79	401.320	0.005	N

XL - 1/5" - 0.200" - 5.08 MM PITCH					
1/4" - 6.40 MM WIDE					
Item description	Product Number	Teeth	Pitch Length (mm)	Weight (kg)	Stock
160-XL-025	9257-21016	80	406.400	0.005	Y
164-XL-025	9277-42535	82	416.560	0.007	N
166-XL-025	9277-52375	83	421.640	0.005	N
170-XL-025	9257-21017	85	431.800	0.005	Y
174-XL-025	9277-53992	87	441.960	0.006	N
176-XL-025	9277-52424	88	447.040	0.006	N
178-XL-025	9277-42537	89	452.120	0.007	N
180-XL-025	9257-21018	90	457.200	0.006	N
182-XL-025	9277-53988	91	462.280	0.005	Y
184-XL-025	9277-53990	92	467.360	0.006	N
188-XL-025	9277-42539	94	477.520	0.008	N
190-XL-025	9257-21019	95	482.600	0.006	Y
192-XL-025	9277-53987	96	487.680	0.006	N
194-XL-025	9277-42541	97	492.760	0.008	N
196-XL-025	9277-42544	98	497.840	0.008	N
200-XL-025	9257-21020	100	508.000	0.006	Y
202-XL-025	9277-41720	101	513.080	0.008	N
204-XL-025	9277-53995	102	518.160	0.007	N
208-XL-025	9277-53997	104	528.320	0.007	N
210-XL-025	9257-21021	105	533.400	0.007	Y
212-XL-025	9277-52585	106	538.480	0.007	N
214-XL-025	9277-42550	107	543.560	0.009	N
220-XL-025	9257-21022	110	558.800	0.007	Y
228-XL-025	9277-54002	114	579.120	0.007	N
230-XL-025	9257-21023	115	584.200	0.008	Y
232-XL-025	9277-42553	116	589.280	0.007	N
234-XL-025	9277-42556	117	594.360	0.000	N
240-XL-025	9257-21024	120	609.600	0.008	Y
250-XL-025	9257-21025	125	635.000	0.008	Y
260-XL-025	9257-21026	130	660.400	0.008	Y
264-XL-025	9277-41758	132	670.560	0.009	N
270-XL-025	9277-40806	135	685.800	0.012	Y
274-XL-025	9277-52746	137	695.960	0.009	N
280-XL-025	9277-54023	140	711.200	0.009	Y
284-XL-025	9277-54025	142	721.360	0.009	N
286-XL-025	9277-42559	143	726.440	0.009	N
290-XL-025	9277-52764	145	736.600	0.009	Y
296-XL-025	9277-54028	148	751.840	0.010	N
300-XL-025	9277-52770	150	762.000	0.009	Y
306-XL-025	9277-54011	153	777.240	0.010	N
310-XL-025	9277-52810	155	787.400	0.010	Y
316-XL-025	9277-42452	158	802.640	0.014	Y
322-XL-025	9277-42561	161	817.880	0.010	N

POWERGRIP



POWERGRIP TIMING BELTS AND SLABS - MXL, XL, L, H, XH, XXH

XL - 1/5" - 0.200" - 5.08 MM PITCH					
1/4" - 6.40 MM WIDE					
Item description	Product Number	Teeth	Pitch Length (mm)	Weight (kg)	Stock
330-XL-025	9277-40845	165	838.200	0.015	Y
340-XL-025	9277-40856	170	863.600	0.015	Y
344-XL-025	9277-40863	172	873.760	0.014	N
348-XL-025	9277-52816	174	883.920	0.011	N
350-XL-025	9277-42564	175	889.000	0.011	N
352-XL-025	9277-52818	176	894.080	0.012	N
362-XL-025	9277-42567	181	919.480	0.015	Y
372-XL-025	9277-54901	186	944.880	0.013	N
380-XL-025	9277-54017	190	965.200	0.012	N
382-XL-025	9277-42573	191	970.280	0.012	N
384-XL-025	9277-54019	192	975.360	0.012	N
390-XL-025	9277-40885	195	990.600	0.016	Y
392-XL-025	9277-42575	196	995.680	0.018	N
404-XL-025	9277-42577	202	1026.160	0.000	N
412-XL-025	9277-42579	206	1046.480	0.017	N
424-XL-025	9277-54037	212	1076.960	0.005	Y
432-XL-025	9277-54419	216	1097.280	0.014	N
434-XL-025	9277-54035	217	1102.360	0.006	Y
438-XL-025	9277-42581	219	1112.520	0.000	N
450-XL-025	9277-54032	225	1143.000	0.015	Y
460-XL-025	9277-41789	230	1168.400	0.019	N
490-XL-025	9277-42585	245	1244.600	0.020	N
506-XL-025	9277-52879	253	1285.240	0.016	N
540-XL-025	9257-90170	270	1371.600	0.018	N
554-XL-025	9277-42587	277	1407.160	0.022	N
564-XL-025	9277-42609	282	1432.560	0.000	N
580-XL-025	9277-52891	290	1473.200	0.024	N
592-XL-025	9277-42593	296	1503.680	0.000	N
672-XL-025	9277-54044	336	1706.880	0.022	N
736-XL-025	9277-42597	368	1869.440	0.024	N
770-XL-025	9342-01077	385	1955.800	0.026	N



POWERGRIP TIMING BELTS AND SLABS - MXL, XL, L, H, XH, XXH

XL - 1/5" - 0.200" - 5.08 MM PITCH					
3/16" - 7.90 MM WIDE					
Item description	Product Number	Teeth	Pitch Length (mm)	Weight (kg)	Stock
46-XL-031	9277-42589	23	116.840	0.001	N
50-XL-031	9277-54889	25	127.000	0.002	N
58-XL-031	9277-53944	29	147.320	0.002	N
60-XL-031	9277-51927	30	152.400	0.002	Y
66-XL-031	9277-42596	33	167.640	0.004	N
70-XL-031	9277-53580	35	177.800	0.003	Y
76-XL-031	9277-41761	38	193.040	0.004	N
80-XL-031	9277-51975	40	203.200	0.003	Y
84-XL-031	9277-53974	42	213.360	0.003	N
86-XL-031	9277-41763	43	218.440	0.005	N
88-XL-031	9277-42601	44	223.520	0.004	N
90-XL-031	9277-51985	45	228.600	0.004	Y
92-XL-031	9277-52023	46	233.680	0.004	N
94-XL-031	9277-42603	47	238.760	0.005	N
96-XL-031	9277-42605	48	243.840	0.004	N
98-XL-031	9277-53946	49	248.920	0.004	N
100-XL-031	9277-52043	50	254.000	0.004	Y
102-XL-031	9277-53948	51	259.080	0.004	N
106-XL-031	9277-53949	53	269.240	0.006	N
108-XL-031	9277-42528	54	274.320	0.006	N
110-XL-031	9277-52082	55	279.400	0.004	Y
112-XL-031	9277-42529	56	284.480	0.006	N
114-XL-031	9277-41772	57	289.560	0.005	N
116-XL-031	9256-40783	58	294.640	0.006	N
118-XL-031	9277-42531	59	299.720	0.006	N
120-XL-031	9277-52117	60	304.800	0.005	Y
122-XL-031	9277-53951	61	309.880	0.005	N
124-XL-031	9277-53953	62	314.960	0.005	N
126-XL-031	9277-53955	63	320.040	0.005	N
128-XL-031	9277-53957	64	325.120	0.005	Y
130-XL-031	9277-52179	65	330.200	0.005	Y
132-XL-031	9277-42532	66	335.280	0.007	N
134-XL-031	9277-53958	67	340.360	0.005	N
136-XL-031	9277-42534	68	345.440	0.008	Y
138-XL-031	9277-53960	69	350.520	0.006	N
140-XL-031	9277-52221	70	355.600	0.006	Y
142-XL-031	9277-53963	71	360.680	0.005	N
144-XL-031	9277-53964	72	365.760	0.006	N
146-XL-031	9277-53965	73	370.840	0.006	N
148-XL-031	9277-53966	74	375.920	0.006	N
150-XL-031	9277-52284	75	381.000	0.006	Y
154-XL-031	9277-53979	77	391.160	0.006	N
156-XL-031	9277-53977	78	396.240	0.006	Y

XL - 1/5" - 0.200" - 5.08 MM PITCH					
3/16" - 7.90 MM WIDE					
Item description	Product Number	Teeth	Pitch Length (mm)	Weight (kg)	Stock
158-XL-031	9277-53982	79	401.320	0.006	N
160-XL-031	9277-52330	80	406.400	0.006	Y
164-XL-031	9277-42536	82	416.560	0.008	N
166-XL-031	9277-53984	83	421.640	0.010	N
170-XL-031	9277-52378	85	431.800	0.007	Y
174-XL-031	9277-53993	87	441.960	0.007	N
176-XL-031	9277-53991	88	447.040	0.007	N
178-XL-031	9277-42538	89	452.120	0.009	N
180-XL-031	9277-52464	90	457.200	0.007	Y
182-XL-031	9277-53989	91	462.280	0.014	Y
184-XL-031	9277-53985	92	467.360	0.007	N
188-XL-031	9277-42540	94	477.520	0.010	N
190-XL-031	9277-52477	95	482.600	0.008	Y
192-XL-031	9277-53994	96	487.680	0.007	N
194-XL-031	9277-42542	97	492.760	0.010	N
196-XL-031	9277-41715	98	497.840	0.010	N
200-XL-031	9277-52518	100	508.000	0.008	Y
202-XL-031	9277-42548	101	513.080	0.010	N
204-XL-031	9277-53996	102	518.160	0.008	N
208-XL-031	9277-53998	104	528.320	0.008	N
210-XL-031	9277-52550	105	533.400	0.009	Y
212-XL-031	9277-54000	106	538.480	0.008	N
214-XL-031	9277-42551	107	543.560	0.011	N
220-XL-031	9277-52595	110	558.800	0.009	Y
228-XL-031	9277-54003	114	579.120	0.009	N
230-XL-031	9277-52624	115	584.200	0.010	Y
232-XL-031	9277-42554	116	589.280	0.000	N
234-XL-031	9277-42557	117	594.360	0.009	N
240-XL-031	9277-52673	120	609.600	0.010	Y
250-XL-031	9277-52705	125	635.000	0.010	Y
260-XL-031	9277-53581	130	660.400	0.010	Y
264-XL-031	9277-54021	132	670.560	0.010	N
270-XL-031	9277-40811	135	685.800	0.015	Y
274-XL-031	9277-54022	137	695.960	0.011	N
280-XL-031	9277-54024	140	711.200	0.014	Y
284-XL-031	9277-54026	142	721.360	0.011	N
286-XL-031	9277-42560	143	726.440	0.000	N
290-XL-031	9277-54027	145	736.600	0.057	Y
296-XL-031	9277-54029	148	751.840	0.012	N
300-XL-031	9277-52779	150	762.000	0.012	Y
306-XL-031	9277-54012	153	777.240	0.012	N
310-XL-031	9277-54013	155	787.400	0.012	Y
316-XL-031	9277-42370	158	802.640	0.016	Y



POWERGRIP TIMING BELTS AND SLABS - MXL, XL, L, H, XH, XXH

XL - 1/5" - 0.200" - 5.08 MM PITCH					
3/16" - 7.90 MM WIDE					
Item description	Product Number	Teeth	Pitch Length (mm)	Weight (kg)	Stock
322-XL-031	9277-42426	161	817.880	0.018	N
330-XL-031	9277-40847	165	838.200	0.018	Y
340-XL-031	9277-42562	170	863.600	0.019	Y
344-XL-031	9277-42563	172	873.760	0.000	N
348-XL-031	9277-54014	174	883.920	0.014	N
350-XL-031	9277-42565	175	889.000	0.018	N
352-XL-031	9277-54681	176	894.080	0.014	N
362-XL-031	9277-42568	181	919.480	0.021	Y
372-XL-031	9277-52834	186	944.880	0.015	N
380-XL-031	9277-54018	190	965.200	0.006	N
382-XL-031	9277-42574	191	970.280	0.000	N
384-XL-031	9277-54020	192	975.360	0.015	N
390-XL-031	9277-41748	195	990.600	0.022	Y
392-XL-031	9277-42576	196	995.680	0.020	N
404-XL-031	9277-42578	202	1026.160	0.000	N
412-XL-031	9277-41756	206	1046.480	0.023	N
424-XL-031	9277-54038	212	1076.960	0.017	Y
432-XL-031	9277-52860	216	1097.280	0.017	N
434-XL-031	9277-54036	217	1102.360	0.017	Y
438-XL-031	9277-42582	219	1112.520	0.000	N
450-XL-031	9277-54033	225	1143.000	0.055	Y
460-XL-031	9277-42584	230	1168.400	0.019	N
490-XL-031	9277-42586	245	1244.600	0.025	N
506-XL-031	9277-52875	253	1285.240	0.020	N
540-XL-031	9277-54034	270	1371.600	0.022	N
554-XL-031	9277-42608	277	1407.160	0.000	N
564-XL-031	9277-42591	282	1432.560	0.028	N
580-XL-031	9277-54031	290	1473.200	0.023	N
592-XL-031	9277-42594	296	1503.680	0.000	N
672-XL-031	9277-54045	336	1706.880	0.027	N
736-XL-031	9277-42598	368	1869.440	0.000	N
770-XL-031	9342-01079	385	1955.800	0.031	N



POWERGRIP TIMING BELTS AND SLABS - MXL, XL, L, H, XH, XXH

XL - 1/5" - 0.200" - 5.08 MM PITCH					
3/8" - 9.5 MM WIDE					
Item description	Product Number	Teeth	Pitch Length (mm)	Weight (kg)	Stock
46-XL-037	9277-42590	23	116.840	0.002	N
50-XL-037	9257-01321	25	127.000	0.003	N
58-XL-037	9277-53969	29	147.320	0.003	N
60-XL-037	9257-22006	30	152.400	0.003	Y
66-XL-037	9277-40760	33	167.640	0.003	N
70-XL-037	9257-22007	35	177.800	0.003	Y
76-XL-037	9277-40454	38	193.040	0.005	N
80-XL-037	9257-22008	40	203.200	0.004	Y
84-XL-037	9277-51983	42	213.360	0.004	N
86-XL-037	9277-41764	43	218.440	0.006	N
88-XL-037	9277-40469	44	223.520	0.006	N
90-XL-037	9257-22009	45	228.600	0.004	Y
92-XL-037	9277-52022	46	233.680	0.004	N
94-XL-037	9277-42385	47	238.760	0.006	N
96-XL-037	9277-42606	48	243.840	0.006	N
98-XL-037	9277-52028	49	248.920	0.005	N
100-XL-037	9257-22010	50	254.000	0.005	Y
102-XL-037	9257-90181	51	259.080	0.005	N
106-XL-037	9277-52074	53	269.240	0.005	N
108-XL-037	9277-40506	54	274.320	0.007	N
110-XL-037	9257-22011	55	279.400	0.005	Y
112-XL-037	9277-40527	56	284.480	0.005	N
114-XL-037	9277-40532	57	289.560	0.007	N
116-XL-037	9277-40537	58	294.640	0.007	N
118-XL-037	9277-42411	59	299.720	0.007	N
120-XL-037	9257-22012	60	304.800	0.006	Y
122-XL-037	9277-52167	61	309.880	0.006	N
124-XL-037	9257-90180	62	314.960	0.006	N
126-XL-037	9277-52176	63	320.040	0.006	N
128-XL-037	9257-90059	64	325.120	0.006	Y
130-XL-037	9257-22013	65	330.200	0.006	Y
132-XL-037	9277-42458	66	335.280	0.009	N
134-XL-037	9277-52217	67	340.360	0.009	N
136-XL-037	9277-40580	68	345.440	0.009	Y
138-XL-037	9277-53961	69	350.520	0.007	N
140-XL-037	9257-22014	70	355.600	0.007	Y
142-XL-037	9277-52265	71	360.680	0.007	N
144-XL-037	9277-52268	72	365.760	0.007	N
146-XL-037	9257-90232	73	370.840	0.007	N
148-XL-037	9277-53967	74	375.920	0.007	N
150-XL-037	9257-22015	75	381.000	0.007	Y
154-XL-037	9277-53980	77	391.160	0.007	N
156-XL-037	9277-53978	78	396.240	0.007	Y

XL - 1/5" - 0.200" - 5.08 MM PITCH					
3/8" - 9.5 MM WIDE					
Item description	Product Number	Teeth	Pitch Length (mm)	Weight (kg)	Stock
158-XL-037	9277-53983	79	401.320	0.007	N
160-XL-037	9257-22016	80	406.400	0.008	Y
164-XL-037	9277-40640	82	416.560	0.010	N
166-XL-037	9277-52374	83	421.640	0.008	N
170-XL-037	9257-22017	85	431.800	0.008	Y
174-XL-037	9277-52421	87	441.960	0.008	N
176-XL-037	9277-52425	88	447.040	0.009	N
178-XL-037	9277-40661	89	452.120	0.011	N
180-XL-037	9257-22018	90	457.200	0.009	Y
182-XL-037	9277-52471	91	462.280	0.009	Y
184-XL-037	9277-53986	92	467.360	0.009	N
188-XL-037	9277-40694	94	477.520	0.013	N
190-XL-037	9257-22019	95	482.600	0.009	Y
192-XL-037	9277-52516	96	487.680	0.009	N
194-XL-037	9277-42543	97	492.760	0.012	N
196-XL-037	9277-42545	98	497.840	0.012	N
200-XL-037	9257-22020	100	508.000	0.009	Y
202-XL-037	9277-42549	101	513.080	0.012	N
204-XL-037	9277-52547	102	518.160	0.010	N
208-XL-037	9277-53999	104	528.320	0.004	N
210-XL-037	9257-22021	105	533.400	0.010	Y
212-XL-037	9277-54001	106	538.480	0.010	N
214-XL-037	9277-42552	107	543.560	0.013	N
220-XL-037	9257-22022	110	558.800	0.011	Y
228-XL-037	9277-52621	114	579.120	0.011	N
230-XL-037	9257-22023	115	584.200	0.011	Y
232-XL-037	9277-42555	116	589.280	0.014	N
234-XL-037	9277-42558	117	594.360	0.011	N
240-XL-037	9257-22024	120	609.600	0.012	Y
250-XL-037	9257-22025	125	635.000	0.012	Y
260-XL-037	9257-22026	130	660.400	0.013	Y
264-XL-037	9277-52742	132	670.560	0.013	N
270-XL-037	9277-40812	135	685.800	0.018	Y
274-XL-037	9277-52744	137	695.960	0.014	N
280-XL-037	9257-90070	140	711.200	0.014	Y
284-XL-037	9277-52760	142	721.360	0.014	N
286-XL-037	9277-40823	143	726.440	0.017	N
290-XL-037	9277-52761	145	736.600	0.015	Y
296-XL-037	9277-54030	148	751.840	0.014	N
300-XL-037	9257-90128	150	762.000	0.015	Y
306-XL-037	9277-54685	153	777.240	0.015	N
310-XL-037	9277-52797	155	787.400	0.015	Y
316-XL-037	9277-40838	158	802.640	0.019	Y

POWERGRIP



POWERGRIP TIMING BELTS AND SLABS - MXL, XL, L, H, XH, XXH

XL - 1/5" - 0.200" - 5.08 MM PITCH					
3/8" - 9.5 MM WIDE					
Item description	Product Number	Teeth	Pitch Length (mm)	Weight (kg)	Stock
322-XL-037	9277-40842	161	817.880	0.020	N
330-XL-037	9277-40848	165	838.200	0.022	Y
340-XL-037	9277-41740	170	863.600	0.021	Y
344-XL-037	9277-40865	172	873.760	0.021	N
348-XL-037	9277-54015	174	883.920	0.017	N
350-XL-037	9277-42566	175	889.000	0.021	N
352-XL-037	9277-52817	176	894.080	0.018	N
362-XL-037	9277-40878	181	919.480	0.022	Y
372-XL-037	9277-52827	186	944.880	0.019	N
380-XL-037	9277-52836	190	965.200	0.019	N
382-XL-037	9277-40882	191	970.280	0.023	N
384-XL-037	9277-52848	192	975.360	0.019	N
390-XL-037	9277-40889	195	990.600	0.024	Y
392-XL-037	9277-41751	196	995.680	0.024	N
404-XL-037	9277-41754	202	1026.160	0.024	N
412-XL-037	9277-42580	206	1046.480	0.025	N
424-XL-037	9277-52855	212	1076.960	0.022	Y
432-XL-037	9277-52859	216	1097.280	0.022	N
434-XL-037	9277-52863	217	1102.360	0.022	Y
438-XL-037	9277-42583	219	1112.520	0.026	N
450-XL-037	9277-52871	225	1143.000	0.021	Y
460-XL-037	9277-40929	230	1168.400	0.028	N
490-XL-037	9277-40933	245	1244.600	0.030	N
506-XL-037	9277-52880	253	1285.240	0.025	N
540-XL-037	9277-52884	270	1371.600	0.026	N
554-XL-037	9277-42401	277	1407.160	0.033	N
564-XL-037	9277-42592	282	1432.560	0.034	N
580-XL-037	9277-52894	290	1473.200	0.029	N
592-XL-037	9277-42414	296	1503.680	0.036	N
672-XL-037	9277-52899	336	1706.880	0.034	N
736-XL-037	9277-42357	368	1869.440	0.044	N
770-XL-037	9277-52903	385	1955.800	0.037	N



POWERGRIP TIMING BELTS AND SLABS - MXL, XL, L, H, XH, XXH

XL - 1/5" - 0.200" - 5.08 MM PITCH						
SLABS						
Item description	Product Number	Teeth	Pitch Length (mm)	Weight (kg)	Stock	Width (inch)
46-XL	9254-40681	23	116.840	0.11	N	18
50-XL	9254-08400	25	127.000	0.12	N	16
58-XL	9254-50322	29	147.320	0.14	N	18
60-XL	9254-50324	30	152.400	0.14	Y	18
66-XL	9254-40080	33	167.640	0.15	N	18
70-XL	9254-50332	35	177.800	0.25	Y	28
76-XL	9254-40082	38	193.040	0.18	N	18
80-XL	9254-50335	40	203.200	0.29	Y	28
84-XL	9254-50341	42	213.360	0.30	N	28
86-XL	9254-40087	43	218.440	0.20	N	18
88-XL	9254-40561	44	223.520	0.45	N	28
90-XL	9254-50343	45	228.600	0.33	Y	28
92-XL	9254-50347	46	233.680	0.21	N	18
94-XL	9254-40091	47	238.760	0.22	N	18
96-XL	9254-40683	48	243.840	0.50	N	28
98-XL	9254-50350	49	248.920	0.35	N	28
100-XL	9254-50353	50	254.000	0.36	Y	28
102-XL	9254-50357	51	259.080	0.37	N	28
106-XL	9254-40095	53	269.240	0.37	N	18
108-XL	9254-40558	54	274.320	0.39	N	28
110-XL	9254-50364	55	279.400	0.40	Y	28
112-XL	9254-40101	56	284.480	0.39	N	18
114-XL	9254-40102	57	289.560	0.27	N	18
116-XL	9254-40103	58	294.640	0.40	N	18
118-XL	9254-40104	59	299.720	0.41	N	18
120-XL	9254-50365	60	304.800	0.43	Y	28
122-XL	9254-50370	61	309.880	0.44	N	28
124-XL	9254-50371	62	314.960	0.51	N	28
126-XL	9254-40107	63	320.040	0.44	N	18
128-XL	9254-50373	64	325.120	0.46	Y	28
130-XL	9254-50377	65	330.200	0.47	Y	28
132-XL	9254-53746	66	335.280	0.31	N	18
134-XL	9254-50380	67	340.360	0.31	N	18
136-XL	9254-40113	68	345.440	0.47	Y	18
138-XL	9254-50381	69	350.520	0.23	N	13
140-XL	9254-50387	70	355.600	0.51	Y	28
142-XL	9254-50388	71	360.680	0.33	N	18
144-XL	9254-50389	72	365.760	0.52	N	28
146-XL	9254-50390	73	370.840	0.34	N	18
148-XL	9254-52976	74	375.920	0.54	N	28
150-XL	9254-50395	75	381.000	0.54	Y	28
154-XL	9254-50396	77	391.160	0.36	N	18
156-XL	9254-53448	78	396.240	0.60	Y	28

XL - 1/5" - 0.200" - 5.08 MM PITCH						
SLABS						
Item description	Product Number	Teeth	Pitch Length (mm)	Weight (kg)	Stock	Width (inch)
158-XL	9254-53544	79	401.320	0.61	N	28
160-XL	9254-50402	80	406.400	0.58	Y	28
164-XL	9254-40122	82	416.560	0.56	N	18
166-XL	9254-50403	83	421.640	0.39	N	18
170-XL	9254-50409	85	431.800	0.61	Y	28
174-XL	9254-50410	87	441.960	0.67	N	28
176-XL	9254-50411	88	447.040	0.67	N	28
178-XL	9254-40128	89	452.120	0.61	N	18
180-XL	9254-50415	90	457.200	0.65	Y	28
182-XL	9254-50419	91	462.280	0.70	Y	28
184-XL	9254-50420	92	467.360	0.67	N	28
188-XL	9254-40133	94	477.520	0.63	N	18
190-XL	9254-50427	95	482.600	0.69	Y	28
192-XL	9254-50428	96	487.680	0.69	N	28
194-XL	9254-40135	97	492.760	0.65	N	18
196-XL	9254-40136	98	497.840	0.66	N	18
200-XL	9254-50435	100	508.000	0.72	Y	28
202-XL	9254-53730	101	513.080	1.06	N	18
204-XL	9254-50436	102	518.160	0.75	N	28
208-XL	9254-50437	104	528.320	0.76	N	28
210-XL	9254-50444	105	533.400	0.76	Y	28
212-XL	9254-50446	106	538.480	0.49	N	18
214-XL	9254-40144	107	543.560	0.72	N	18
220-XL	9254-50453	110	558.800	0.80	Y	28
228-XL	9254-50455	114	579.120	0.83	N	28
230-XL	9254-53619	115	584.200	0.83	Y	28
232-XL	9254-40149	116	589.280	0.77	N	18
234-XL	9254-40150	117	594.360	0.78	N	18
240-XL	9254-50462	120	609.600	0.87	Y	28
250-XL	9254-50467	125	635.000	0.90	Y	28
260-XL	9254-50474	130	660.400	0.94	Y	28
264-XL	9254-50475	132	670.560	0.61	N	18
270-XL	9254-40566	135	685.800	0.98	Y	28
274-XL	9254-50476	137	695.960	0.46	N	13
280-XL	9254-50477	140	711.200	1.01	Y	28
284-XL	9254-50479	142	721.360	1.08	N	28
286-XL	9254-40161	143	726.440	0.64	N	18
290-XL	9254-50480	145	736.600	1.05	Y	28
296-XL	9254-50482	148	751.840	1.12	N	28
300-XL	9254-50483	150	762.000	0.70	Y	18
306-XL	9254-50487	153	777.240	1.11	N	28
310-XL	9254-52799	155	787.400	1.17	Y	28
316-XL	9254-40165	158	802.640	1.05	Y	18



POWERGRIP TIMING BELTS AND SLABS - MXL, XL, L, H, XH, XXH

XL - 1/5" - 0.200" - 5.08 MM PITCH						
SLABS						
Item description	Product Number	Teeth	Pitch Length (mm)	Weight (kg)	Stock	Width (inch)
322-XL	9254-40166	161	817.880	1.07	N	18
330-XL	9254-40167	165	838.200	1.09	Y	18
340-XL	9254-40171	170	863.600	1.13	Y	18
344-XL	9254-40173	172	873.760	1.14	N	18
348-XL	9254-52801	174	883.920	1.26	N	28
350-XL	9254-40175	175	889.000	1.16	N	18
352-XL	9254-52803	176	894.080	1.27	N	28
362-XL	9254-40178	181	919.480	1.20	Y	18
372-XL	9254-52804	186	944.880	1.34	N	28
380-XL	9254-52806	190	965.200	1.38	N	28
382-XL	9254-40179	191	970.280	1.25	N	18
384-XL	9254-52812	192	975.360	0.89	N	18
390-XL	9254-40180	195	990.600	1.29	Y	18
392-XL	9254-40183	196	995.680	1.29	N	18
404-XL	9254-40184	202	1026.160	1.33	N	18
412-XL	9254-40185	206	1046.480	1.36	N	18
424-XL	9254-01211	212	1076.960	1.50	Y	28
432-XL	9254-40188	216	1097.280	1.43	N	18
434-XL	9254-52815	217	1102.360	1.65	Y	28
438-XL	9254-40189	219	1112.520	1.44	N	18
450-XL	9254-52817	225	1143.000	1.63	Y	28
460-XL	9254-40192	230	1168.400	1.52	N	18
490-XL	9254-40193	245	1244.600	1.42	N	18
506-XL	9254-52820	253	1285.240	1.83	N	28
540-XL	9254-53713	270	1371.600	1.95	N	28
554-XL	9254-40195	277	1407.160	1.29	N	18
564-XL	9254-40684	282	1432.560	2.04	N	28
580-XL	9254-52823	290	1473.200	1.35	N	18
592-XL	9254-40197	296	1503.680	1.37	N	18
672-XL	9254-53601	336	1706.880	2.43	N	28
736-XL	9254-40198	368	1869.440	1.71	N	18
770-XL	9254-08540	385	1955.800	1.29	N	13



POWERGRIP TIMING BELTS AND SLABS - MXL, XL, L, H, XH, XXH

L - 3/8" - 0.375" - 9.525 MM PITCH					
1/2" - 12.5 MM WIDE					
Item description	Product Number	Teeth	Pitch Length (mm)	Weight (kg)	Stock
124-L-050	9257-31012	33	314.330	0.01	Y
135-L-050	9277-40014	36	342.900	0.02	N
150-L-050	9257-31015	40	381.000	0.02	Y
165-L-050	9277-50055	44	419.100	0.02	N
169-L-050	9277-40032	45	428.630	0.02	Y
172-L-050	9277-50059	46	438.150	0.02	N
187-L-050	9257-31018	50	476.250	0.02	Y
202-L-050	9277-50099	54	514.350	0.02	Y
210-L-050	9257-31021	56	533.400	0.02	Y
225-L-050	9257-31022	60	571.500	0.02	Y
236-L-050	9277-40075	63	600.080	0.02	N
240-L-050	9257-31024	64	609.600	0.02	Y
244-L-050	9277-50678	65	619.130	0.03	N
251-L-050	9277-41804	67	638.180	0.03	N
255-L-050	9257-31025	68	647.700	0.03	Y
270-L-050	9257-31027	72	685.800	0.03	Y
285-L-050	9257-31028	76	723.900	0.03	Y
300-L-050	9257-31030	80	762.000	0.03	Y
322-L-050	9257-31032	86	819.150	0.03	Y
345-L-050	9257-31034	92	876.300	0.04	Y
367-L-050	9257-31036	98	933.450	0.04	Y
390-L-050	9257-31039	104	990.600	0.04	Y
405-L-050	9277-40181	108	1028.700	0.05	Y
420-L-050	9257-31042	112	1066.800	0.04	Y
450-L-050	9257-31045	120	1143.000	0.05	Y
461-L-050	9277-53892	123	1171.580	0.05	N
480-L-050	9257-31048	128	1219.200	0.05	Y
510-L-050	9257-31051	136	1295.400	0.05	Y
540-L-050	9257-31054	144	1371.600	0.06	Y
600-L-050	9257-31060	160	1524.000	0.06	Y
630-L-050	9277-50624	168	1600.200	0.06	Y
660-L-050	9277-50634	176	1676.400	0.07	Y

L - 3/8" - 0.375" - 9.525 MM PITCH					
3/4" - 19.1 MM WIDE					
Item description	Product Number	Teeth	Pitch Length (mm)	Weight (kg)	Stock
124-L-075	9257-32012	33	314.33	0.019	Y
135-L-075	9277-40016	36	342.9	0.025	N
150-L-075	9257-32015	40	381	0.023	Y
165-L-075	9277-50056	44	419.100	0.03	N
169-L-075	9277-40033	45	428.630	0.03	Y
172-L-075	9277-50062	46	438.150	0.03	N
187-L-075	9257-32018	50	476.250	0.03	Y
202-L-075	9277-50098	54	514.350	0.03	Y
210-L-075	9257-32021	56	533.400	0.03	Y
225-L-075	9257-32022	60	571.500	0.04	Y
236-L-075	9277-41802	63	600.080	0.04	N
240-L-075	9257-32024	64	609.600	0.04	Y
244-L-075	9277-54043	65	619.130	0.04	N
251-L-075	9277-41805	67	638.180	0.05	N
255-L-075	9257-32025	68	647.700	0.04	Y
270-L-075	9257-32027	72	685.800	0.04	Y
285-L-075	9257-32028	76	723.900	0.04	Y
300-L-075	9257-32030	80	762.000	0.05	Y
322-L-075	9257-32032	86	819.150	0.05	Y
345-L-075	9257-32034	92	876.300	0.05	Y
367-L-075	9257-32036	98	933.450	0.06	Y
390-L-075	9257-32039	104	990.600	0.06	Y
405-L-075	9277-41807	108	1028.700	0.06	Y
420-L-075	9257-32042	112	1066.800	0.06	Y
450-L-075	9257-32045	120	1143.000	0.07	Y
461-L-075	9277-54040	123	1171.580	0.07	N
480-L-075	9257-32048	128	1219.200	0.07	Y
510-L-075	9257-32051	136	1295.400	0.08	Y
540-L-075	9257-32054	144	1371.600	0.08	Y
600-L-075	9257-32060	160	1524.000	0.09	Y
630-L-075	9277-50631	168	1600.200	0.10	Y
660-L-075	9277-50637	176	1676.400	0.10	Y

POWERGRIP TIMING BELTS AND SLABS - MXL, XL, L, H, XH, XXH

L - 3/8" - 0.375" - 9.525 MM PITCH					
1" - 25.4 MM WIDE					
Item description	Product Number	Teeth	Pitch Length (mm)	Weight (kg)	Stock
124-L-100	9257-33012	33	314.330	0.03	Y
135-L-100	9277-40017	36	342.900	0.03	N
150-L-100	9257-33015	40	381.000	0.03	Y
165-L-100	9257-90165	44	419.100	0.04	N
169-L-100	9277-40034	45	428.630	0.04	Y
172-L-100	9277-50058	46	438.150	0.03	N
187-L-100	9257-33018	50	476.250	0.04	Y
202-L-100	9277-50100	54	514.350	0.04	Y
210-L-100	9257-33021	56	533.400	0.04	Y
225-L-100	9257-33022	60	571.500	0.05	Y
236-L-100	9277-41803	63	600.080	0.05	N
240-L-100	9257-33024	64	609.600	0.05	Y
244-L-100	9277-54039	65	619.130	0.05	N
251-L-100	9277-41806	67	638.180	0.05	N
255-L-100	9257-33025	68	647.700	0.05	Y
270-L-100	9257-33027	72	685.800	0.06	Y
285-L-100	9257-33028	76	723.900	0.06	Y
300-L-100	9257-33030	80	762.000	0.06	Y
322-L-100	9257-33032	86	819.150	0.07	Y
345-L-100	9257-33034	92	876.300	0.07	Y
367-L-100	9257-33036	98	933.450	0.08	Y
390-L-100	9257-33039	104	990.600	0.08	Y
405-L-100	9277-41808	108	1028.700	0.10	Y
420-L-100	9257-33042	112	1066.800	0.09	Y
450-L-100	9257-33045	120	1143.000	0.09	Y
461-L-100	9277-54041	123	1171.580	0.10	N
480-L-100	9257-33048	128	1219.200	0.10	Y
510-L-100	9257-33051	136	1295.400	0.11	Y
540-L-100	9257-33054	144	1371.600	0.11	Y
600-L-100	9257-33060	160	1524.000	0.13	Y
630-L-100	9277-50632	168	1600.200	0.13	Y
660-L-100	9277-50633	176	1676.400	0.14	Y

L - 3/8" - 0.375"						
9.525 MM PITCH - SLABS						
Item description	Product Number	Teeth	Pitch Length (mm)	Weight (kg)	Stock	Width (inch)
124-L	9254-50003	33	314.330	0.69	Y	28
135-L	9254-40004	36	342.900	0.68	N	18
150-L	9254-50011	40	381.000	0.84	Y	28
165-L	9254-50014	44	419.100	0.59	N	18
169-L	9254-40703	45	428.630	1.21	Y	28
172-L	9254-53616	46	438.150	0.97	N	28
187-L	9254-50020	50	476.250	1.05	Y	28
202-L	9254-50025	54	514.350	1.13	Y	28
210-L	9254-50031	56	533.400	1.18	Y	28
225-L	9254-50037	60	571.500	1.26	Y	28
236-L	9254-40015	63	600.080	1.15	N	18
240-L	9254-50041	64	609.600	1.34	Y	28
244-L	9254-50134	65	619.130	1.34	N	28
251-L	9254-40018	67	638.180	1.21	N	18
255-L	9254-50049	68	647.700	1.43	Y	28
270-L	9254-50055	72	685.800	1.51	Y	28
285-L	9254-50062	76	723.900	1.60	Y	28
300-L	9254-50065	80	762.000	1.68	Y	28
322-L	9254-50073	86	819.150	1.81	Y	28
345-L	9254-50078	92	876.300	1.93	Y	28
367-L	9254-50127	98	933.450	2.06	Y	28
390-L	9254-50132	104	990.600	2.18	Y	28
405-L	9254-40035	108	1028.700	1.46	Y	18
420-L	9254-50083	112	1066.800	2.45	Y	28
450-L	9254-50093	120	1143.000	2.52	Y	28
461-L	9254-50094	123	1171.580	1.66	N	18
480-L	9254-50100	128	1219.200	2.69	Y	28
510-L	9254-50103	136	1295.400	1.84	Y	18
540-L	9254-50110	144	1371.600	1.94	Y	18
600-L	9254-50116	160	1524.000	2.16	Y	18
630-L	9254-50120	168	1600.200	2.27	Y	18
660-L	9254-50121	176	1676.400	2.38	Y	18



POWERGRIP TIMING BELTS AND SLABS - MXL, XL, L, H, XH, XXH

H - 1/2" - 0.500" - 12.7 MM PITCH					
3/4" - 19.1 MM WIDE					
Item description	Product Number	Teeth	Pitch Length (mm)	Weight (kg)	Stock
240-H-075	9257-41024	48	609.600	0.04	Y
255-H-075	9277-50725	51	647.700	0.07	N
270-H-075	9257-41027	54	685.800	0.05	Y
300-H-075	9257-41030	60	762.000	0.06	Y
310-H-075	9277-41809	62	787.400	0.08	Y
330-H-075	9257-41033	66	838.200	0.06	Y
360-H-075	9257-41036	72	914.400	0.07	Y
370-H-075	9277-40315	74	939.800	0.09	N
375-H-075	9277-50907	75	952.500	0.07	N
390-H-075	9257-41039	78	990.600	0.07	Y
420-H-075	9257-41042	84	1066.800	0.08	Y
440-H-075	9277-54078	88	1117.600	0.08	Y
450-H-075	9257-41045	90	1143.000	0.09	Y
480-H-075	9257-41048	96	1219.200	0.09	Y
485-H-075	9277-54074	97	1231.900	0.09	N
510-H-075	9257-41051	102	1295.400	0.10	Y
520-H-075	9277-54073	104	1320.800	0.09	N
540-H-075	9257-41054	108	1371.600	0.10	Y
570-H-075	9257-41057	114	1447.800	0.11	Y
600-H-075	9257-41060	120	1524.000	0.11	Y
615-H-075	9277-41815	123	1562.100	0.15	N
630-H-075	9257-41063	126	1600.200	0.12	Y
660-H-075	9257-41066	132	1676.400	0.12	Y
700-H-075	9257-41070	140	1778.000	0.13	Y
750-H-075	9277-51470	150	1905.000	0.14	Y
800-H-075	9257-41080	160	2032.000	0.15	Y
850-H-075	9257-41085	170	2159.000	0.20	Y
885-H-075	9277-54070	177	2247.900	0.19	N
900-H-075	9277-51611	180	2286.000	0.21	Y
905-H-075	9277-54921	181	2298.700	0.23	N
1000-H-075	9257-41100	200	2540.000	0.23	Y
1100-H-075	9257-41110	220	2794.000	0.25	Y
1130-H-075	9277-54063	226	2870.200	0.22	N
1250-H-075	9257-41125	250	3175.000	0.29	Y
1325-H-075	9277-54061	265	3365.500	0.03	Y
1400-H-075	9257-41140	280	3556.000	0.32	Y
1460-H-075	9277-54056	292	3708.400	0.28	N
1700-H-075	9257-41170	340	4318.000	0.39	Y

H - 1/2" - 0.500" - 12.7 MM PITCH					
1" - 25.4 MM WIDE					
Item description	Product Number	Teeth	Pitch Length (mm)	Weight (kg)	Stock
240-H-100	9257-42024	48	609.600	0.06	Y
255-H-100	9277-50722	51	647.700	0.06	N
270-H-100	9257-42027	54	685.800	0.07	Y
300-H-100	9257-42030	60	762.000	0.07	Y
310-H-100	9277-40281	62	787.400	0.11	Y
330-H-100	9257-42033	66	838.200	0.08	Y
360-H-100	9257-42036	72	914.400	0.09	Y
370-H-100	9277-40317	74	939.800	0.13	N
375-H-100	9257-90177	75	952.500	0.10	N
390-H-100	9257-42039	78	990.600	0.09	Y
420-H-100	9257-42042	84	1066.800	0.10	Y
440-H-100	9277-51020	88	1117.600	0.11	Y
450-H-100	9257-42045	90	1143.000	0.11	Y
480-H-100	9257-42048	96	1219.200	0.12	Y
485-H-100	9277-54075	97	1231.900	0.12	N
510-H-100	9257-42051	102	1295.400	0.13	Y
520-H-100	9277-51153	104	1320.800	0.13	N
540-H-100	9257-42054	108	1371.600	0.13	Y
570-H-100	9257-42057	114	1447.800	0.14	Y
600-H-100	9257-42060	120	1524.000	0.15	Y
615-H-100	9277-40436	123	1562.100	0.21	N
630-H-100	9257-42063	126	1600.200	0.16	Y
660-H-100	9257-42066	132	1676.400	0.16	Y
700-H-100	9257-42070	140	1778.000	0.18	Y
750-H-100	9277-54876	150	1905.000	0.19	Y
800-H-100	9257-42080	160	2032.000	0.20	Y
850-H-100	9257-42085	170	2159.000	0.22	Y
885-H-100	9277-54065	177	2247.900	0.23	N
900-H-100	9257-42090	180	2286.000	0.28	Y
905-H-100	9277-54922	181	2298.700	0.32	N
1000-H-100	9257-42100	200	2540.000	0.26	Y
1100-H-100	9257-42110	220	2794.000	0.28	Y
1130-H-100	9277-54064	226	2870.200	0.28	N
1250-H-100	9257-42125	250	3175.000	0.32	Y
1325-H-100	9277-51798	265	3365.500	0.41	Y
1400-H-100	9257-42140	280	3556.000	0.36	Y
1460-H-100	9277-54057	292	3708.400	0.38	N
1700-H-100	9257-42170	340	4318.000	0.44	Y

POWERGRIP TIMING BELTS AND SLABS - MXL, XL, L, H, XH, XXH

H - 1/2" - 0.500" - 12.7 MM PITCH					
1,5" - 38.1 MM WIDE					
Item description	Product Number	Teeth	Pitch Length (mm)	Weight (kg)	Stock
240-H-150	9257-43024	48	609.600	0.09	Y
255-H-150	9277-50721	51	647.700	0.10	N
270-H-150	9257-43027	54	685.800	0.10	Y
300-H-150	9257-43030	60	762.000	0.12	Y
310-H-150	9277-41810	62	787.400	0.16	Y
330-H-150	9257-43033	66	838.200	0.13	Y
360-H-150	9257-43036	72	914.400	0.13	Y
370-H-150	9277-40320	74	939.800	0.19	N
375-H-150	9277-54081	75	952.500	0.14	N
390-H-150	9257-43039	78	990.600	0.14	Y
420-H-150	9257-43042	84	1066.800	0.15	Y
440-H-150	9277-51021	88	1117.600	0.17	Y
450-H-150	9257-43045	90	1143.000	0.17	Y
480-H-150	9257-43048	96	1219.200	0.18	Y
485-H-150	9277-54076	97	1231.900	0.18	N
510-H-150	9257-43051	102	1295.400	0.20	Y
520-H-150	9277-54068	104	1320.800	0.20	N
540-H-150	9257-43054	108	1371.600	0.20	Y
570-H-150	9257-43057	114	1447.800	0.21	Y
600-H-150	9257-43060	120	1524.000	0.22	Y
615-H-150	9277-41816	123	1562.100	0.31	N
630-H-150	9257-43063	126	1600.200	0.23	Y
660-H-150	9257-43066	132	1676.400	0.25	Y
700-H-150	9257-43070	140	1778.000	0.26	Y
750-H-150	9277-54877	150	1905.000	0.39	Y
800-H-150	9257-43080	160	2032.000	0.29	Y
850-H-150	9257-43085	170	2159.000	0.41	Y
885-H-150	9277-54066	177	2247.900	0.15	N
900-H-150	9257-43090	180	2286.000	0.45	Y
905-H-150	9277-54923	181	2298.700	0.47	N
1000-H-150	9257-43100	200	2540.000	0.49	Y
1100-H-150	9257-43110	220	2794.000	0.53	Y
1130-H-150	9277-54059	226	2870.200	0.44	N
1250-H-150	9257-43125	250	3175.000	0.61	Y
1325-H-150	9277-54557	265	3365.500	0.64	Y
1400-H-150	9257-43140	280	3556.000	0.68	Y
1460-H-150	9277-54058	292	3708.400	0.57	N
1700-H-150	9257-43170	340	4318.000	0.82	Y

H - 1/2" - 0.500" - 12.7 MM PITCH					
2" - 50.8 MM WIDE					
Item description	Product Number	Teeth	Pitch Length (mm)	Weight (kg)	Stock
240-H-200	9257-44024	48	609.600	0.12	Y
255-H-200	9277-54080	51	647.700	0.13	N
270-H-200	9257-44027	54	685.800	0.14	Y
300-H-200	9257-44030	60	762.000	0.15	Y
310-H-200	9277-41811	62	787.400	0.21	Y
330-H-200	9257-44033	66	838.200	0.17	Y
360-H-200	9257-44036	72	914.400	0.18	Y
370-H-200	9277-54371	74	939.800	0.25	N
375-H-200	9277-54082	75	952.500	0.19	N
390-H-200	9257-44039	78	990.600	0.19	Y
420-H-200	9257-44042	84	1066.800	0.20	Y
440-H-200	9277-51019	88	1117.600	0.24	Y
450-H-200	9257-44045	90	1143.000	0.24	Y
480-H-200	9257-44048	96	1219.200	0.24	Y
485-H-200	9277-54071	97	1231.900	0.26	N
510-H-200	9257-44051	102	1295.400	0.27	Y
520-H-200	9277-51152	104	1320.800	0.27	N
540-H-200	9257-44054	108	1371.600	0.26	Y
570-H-200	9257-44057	114	1447.800	0.28	Y
600-H-200	9257-44060	120	1524.000	0.29	Y
615-H-200	9277-41817	123	1562.100	0.42	N
630-H-200	9257-44063	126	1600.200	0.31	Y
660-H-200	9257-44066	132	1676.400	0.32	Y
700-H-200	9257-44070	140	1778.000	0.37	Y
750-H-200	9277-54878	150	1905.000	0.52	Y
800-H-200	9257-44080	160	2032.000	0.42	Y
850-H-200	9257-44085	170	2159.000	0.53	Y
885-H-200	9277-54067	177	2247.900	0.49	N
900-H-200	9257-44090	180	2286.000	0.56	Y
905-H-200	9277-54924	181	2298.700	0.63	N
1000-H-200	9257-44100	200	2540.000	0.52	Y
1100-H-200	9257-44110	220	2794.000	0.57	Y
1130-H-200	9277-51744	226	2870.200	0.58	N
1250-H-200	9257-44125	250	3175.000	0.78	Y
1325-H-200	9257-90240	265	3365.500	0.83	Y
1400-H-200	9257-44140	280	3556.000	0.87	Y
1460-H-200	9277-51852	292	3708.400	0.75	N
1700-H-200	9257-44170	340	4318.000	0.88	Y



POWERGRIP TIMING BELTS AND SLABS - MXL, XL, L, H, XH, XXH

H - 1/2" - 0.500" -12.7 MM PITCH					
3" - 76.2 MM WIDE					
Item description	Product Number	Teeth	Pitch Length (mm)	Weight (kg)	Stock
240-H-300	9257-45024	48	609.600	0.19	Y
255-H-300	9257-90237	51	647.700	0.20	N
270-H-300	9257-45027	54	685.800	0.22	Y
300-H-300	9257-45030	60	762.000	0.24	Y
310-H-300	9277-41812	62	787.400	0.32	Y
330-H-300	9257-45033	66	838.200	0.27	Y
360-H-300	9257-45036	72	914.400	0.29	Y
370-H-300	9277-41814	74	939.800	0.38	N
375-H-300	9277-54077	75	952.500	0.29	N
390-H-300	9257-45039	78	990.600	0.31	Y
420-H-300	9257-45042	84	1066.800	0.34	Y
440-H-300	9277-54079	88	1117.600	0.30	Y
450-H-300	9257-45045	90	1143.000	0.37	Y
480-H-300	9257-45048	96	1219.200	0.38	Y
485-H-300	9277-54072	97	1231.900	0.37	N
510-H-300	9257-45051	102	1295.400	0.41	Y
520-H-300	9277-54069	104	1320.800	0.16	N
540-H-300	9257-45054	108	1371.600	0.42	Y
570-H-300	9257-45057	114	1447.800	0.44	Y
600-H-300	9257-45060	120	1524.000	0.46	Y
615-H-300	9277-41818	123	1562.100	0.62	N
630-H-300	9257-45063	126	1600.200	0.49	Y
660-H-300	9257-45066	132	1676.400	0.51	Y
700-H-300	9257-45070	140	1778.000	0.56	Y
750-H-300	9257-45075	150	1905.000	0.60	Y
800-H-300	9257-45080	160	2032.000	0.64	Y
850-H-300	9257-45085	170	2159.000	0.93	Y
885-H-300	9277-54062	177	2247.900	0.31	N
900-H-300	9257-45090	180	2286.000	0.99	Y
905-H-300	9277-54925	181	2298.700	0.70	N
1000-H-300	9257-45100	200	2540.000	1.09	Y
1100-H-300	9257-45110	220	2794.000	1.20	Y
1130-H-300	9277-54060	226	2870.200	1.24	N
1250-H-300	9257-45125	250	3175.000	1.37	Y
1325-H-300	9257-90151	265	3365.500	1.45	Y
1400-H-300	9257-45140	280	3556.000	1.53	Y
1460-H-300	9277-54053	292	3708.400	1.13	N
1700-H-300	9257-45170	340	4318.000	1.85	Y

H - 1/2" - 0.500" - 12.7 MM PITCH						
SLABS						
Item description	Product Number	Teeth	Pitch Length (mm)	Weight (kg)	Stock	Width (inch)
240-H	9254-50140	48	609.600	1.74	Y	28
255-H	9254-50142	51	647.700	1.85	N	28
270-H	9254-50147	54	685.800	1.95	Y	28
300-H	9254-50156	60	762.000	2.16	Y	28
310-H	9254-40054	62	787.400	2.15	Y	18
330-H	9254-50157	66	838.200	2.44	Y	28
360-H	9254-53472	72	914.400	1.64	Y	18
370-H	9254-40059	74	939.800	2.56	N	18
375-H	9254-50171	75	952.500	2.77	N	28
390-H	9254-53483	78	990.600	1.81	Y	18
420-H	9254-53491	84	1066.800	1.91	Y	18
440-H	9254-50187	88	1117.600	2.12	Y	18
450-H	9254-50193	90	1143.000	3.32	Y	28
480-H	9254-53532	96	1219.200	2.18	Y	18
485-H	9254-50202	97	1231.900	2.39	N	18
510-H	9254-50208	102	1295.400	2.44	Y	18
520-H	9254-50209	104	1320.800	1.74	N	13
540-H	9254-50216	108	1371.600	2.45	Y	18
570-H	9254-50221	114	1447.800	2.65	Y	18
600-H	9254-50231	120	1524.000	2.79	Y	18
615-H	9254-40078	123	1562.100	2.87	N	18
630-H	9254-50237	126	1600.200	2.92	Y	18
660-H	9254-50244	132	1676.400	3.06	Y	18
700-H	9254-53680	140	1778.000	5.06	Y	28
750-H	9254-53672	150	1905.000	5.42	Y	28
800-H	9254-53681	160	2032.000	5.78	Y	28
850-H	9254-50273	170	2159.000	2.85	Y	13
885-H	9254-50274	177	2247.900	2.97	N	13
900-H	9254-50278	180	2286.000	3.02	Y	13
905-H	9254-53705	181	2298.700	3.03	N	13
1000-H	9254-50287	200	2540.000	3.35	Y	13
1100-H	9254-50295	220	2794.000	3.69	Y	13
1130-H	9254-50296	226	2870.200	3.79	N	13
1250-H	9254-50302	250	3175.000	4.19	Y	13
1325-H	9254-50303	265	3365.500	4.44	Y	13
1400-H	9254-50309	280	3556.000	4.69	Y	13
1460-H	9254-50311	292	3708.400	4.90	N	13
1700-H	9254-50313	340	4318.000	5.70	Y	13

POWERGRIP TIMING BELTS AND SLABS - MXL, XL, L, H, XH, XXH

XH - 7/8" - 0.875"					
22.225 MM PITCH - 2,00" - 50.8 MM WIDE					
Item description	Product Number	Teeth	Pitch Length (mm)	Weight (kg)	Stock
507-XH-200	9257-51050	58	1289.050	1.03	Y
560-XH-200	9257-51056	64	1422.400	1.13	Y
630-XH-200	9257-51063	72	1600.200	1.28	Y
700-XH-200	9257-51070	80	1778.000	1.08	Y
770-XH-200	9257-51077	88	1955.800	1.19	Y
787-XH-200	9257-54051	90	2000.250	1.60	N
831-XH-200	9277-54093	95	2111.380	1.68	N
840-XH-200	9257-51084	96	2133.600	1.29	Y
980-XH-200	9257-51098	112	2489.200	1.99	Y
1120-XH-200	9257-51112	128	2844.800	2.27	Y
1260-XH-200	9257-51126	144	3200.400	2.55	Y
1400-XH-200	9257-51140	160	3556.000	2.84	Y
1540-XH-200	9257-51154	176	3911.600	3.12	Y
1680-XH-200	9277-54089	192	4267.200	2.76	N
1750-XH-200	9257-51175	200	4445.000	2.67	Y

XH - 7/8" - 0.875"					
22.225 MM PITCH - 3,00" - 76.2 MM WIDE					
Item description	Product Number	Teeth	Pitch Length (mm)	Weight (kg)	Stock
507-XH-300	9257-52050	58	1289.050	1.39	Y
560-XH-300	9257-52056	64	1422.400	1.52	Y
630-XH-300	9257-52063	72	1600.200	1.71	Y
700-XH-300	9257-52070	80	1778.000	2.13	Y
770-XH-300	9257-52077	88	1955.800	2.08	Y
787-XH-300	9277-54052	90	2000.250	2.39	N
831-XH-300	9277-54094	95	2111.380	2.53	N
840-XH-300	9257-52084	96	2133.600	2.26	Y
980-XH-300	9257-52098	112	2489.200	2.98	Y
1120-XH-300	9257-52112	128	2844.800	3.40	Y
1260-XH-300	9257-52126	144	3200.400	3.37	Y
1400-XH-300	9257-52140	160	3556.000	3.74	Y
1540-XH-300	9277-53262	176	3911.600	4.68	Y
1680-XH-300	9277-54090	192	4267.200	4.14	N
1750-XH-300	9257-52175	200	4445.000	4.67	Y

XH - 7/8" - 0.875"					
22.225 MM PITCH - 4,00" - 101.6 MM WIDE					
Item description	Product Number	Teeth	Pitch Length (mm)	Weight (kg)	Stock
507-XH-400	9257-53050	58	1289.050	1.85	Y
560-XH-400	9257-53056	64	1422.400	2.03	Y
630-XH-400	9257-53063	72	1600.200	2.28	Y
700-XH-400	9257-53070	80	1778.000	2.53	Y
770-XH-400	9257-53077	88	1955.800	2.77	Y
787-XH-400	9277-54048	90	2000.250	3.20	N
831-XH-400	9277-54095	95	2111.380	3.38	N
840-XH-400	9257-53084	96	2133.600	3.02	Y
980-XH-400	9257-53098	112	2489.200	3.51	Y
1120-XH-400	9257-53112	128	2844.800	4.00	Y
1260-XH-400	9277-53126	144	3200.400	4.50	Y
1400-XH-400	9277-53242	160	3556.000	4.99	Y
1540-XH-400	9257-53154	176	3911.600	5.48	Y
1680-XH-400	9277-54086	192	4267.200	6.83	N
1750-XH-400	9257-53175	200	4445.000	6.22	Y

XH - 7/8" - 0.875"					
22.225 MM PITCH - 5,00" - 127 MM WIDE					
Item description	Product Number	Teeth	Pitch Length (mm)	Weight (kg)	Stock
507-XH-500	9277-52960	58	1289.050	2.77	Y
560-XH-500	9277-54054	64	1422.400	2.54	Y
630-XH-500	9277-54055	72	1600.200	2.85	Y
700-XH-500	9277-54050	80	1778.000	3.16	Y
770-XH-500	9277-53059	88	1955.800	4.16	Y
787-XH-500	9277-54049	90	2000.250	3.99	N
831-XH-500	9277-54091	95	2111.380	4.21	N
840-XH-500	9277-54092	96	2133.600	4.53	Y
980-XH-500	9257-90038	112	2489.200	5.27	Y
1120-XH-500	9257-90061	128	2844.800	6.01	Y
1260-XH-500	9257-90037	144	3200.400	6.38	Y
1400-XH-500	9277-54466	160	3556.000	7.49	Y
1540-XH-500	9277-54088	176	3911.600	5.88	Y
1680-XH-500	9277-54087	192	4267.200	6.90	N
1750-XH-500	9277-54085	200	4445.000	7.18	Y



POWERGRIP TIMING BELTS AND SLABS - MXL, XL, L, H, XH, XXH

XH - 7/8" - 0.875" - 22.225 MM PITCH						
SLABS						
Item description	Product Number	Teeth	Pitch Length (mm)	Weight (kg)	Stock	Width (inch)
507-XH	9254-52853	58	1289.050	6.68	Y	13
560-XH	9254-52861	64	1422.400	7.37	Y	13
630-XH	9254-52866	72	1600.200	8.29	Y	13
700-XH	9254-52874	80	1778.000	9.21	Y	13
770-XH	9254-52881	88	1955.800	10.13	Y	13
787-XH	9254-52882	90	2000.250	10.36	N	13
831-XH	9254-53202	95	2111.380	10.98	N	13
840-XH	9254-52889	96	2133.600	11.05	Y	13
980-XH	9254-52896	112	2489.200	12.99	Y	13
1120-XH	9254-52903	128	2844.800	14.74	Y	13
1260-XH	9254-52908	144	3200.400	16.58	Y	13
1400-XH	9254-52915	160	3556.000	18.42	Y	13
1540-XH	9254-52917	176	3911.600	20.27	Y	13
1680-XH	9254-52921	192	4267.200	22.11	N	13
1750-XH	9254-52927	200	4445.000	23.03	Y	13

XXH - 1.1/4" - 1.250"						
31.75 MM PITCH - 2,00" - 50.8 MM WIDE						
Item description	Product Number	Teeth	Pitch Length (mm)	Weight (kg)	Stock	
700-XXH-200	9257-05100	56	1778.000	1.81	N	
800-XXH-200	9257-05101	64	2032.000	2.02	N	
900-XXH-200	9257-05102	72	2286.000	2.22	N	
1000-XXH-200	9257-05103	80	2540.000	2.52	N	
1200-XXH-200	9257-05104	96	3048.000	2.88	N	
1400-XXH-200	9257-61140	112	3556.000	3.33	N	
1600-XXH-200	9277-53756	128	4064.000	3.65	N	
1800-XXH-200	9257-05107	144	4572.000	4.06	N	

XXH - 1.1/4" - 1.250"						
31.75 MM PITCH - 3,00" - 76.2 MM WIDE						
Item description	Product Number	Teeth	Pitch Length (mm)	Weight (kg)	Stock	
700-XXH-300	9257-05200	56	1778.000	2.59	N	
800-XXH-300	9257-05201	64	2032.000	2.90	N	
900-XXH-300	9257-05202	72	2286.000	3.11	N	
1000-XXH-300	9257-05203	80	2540.000	3.42	N	
1200-XXH-300	9257-05204	96	3048.000	3.99	N	
1400-XXH-300	9257-62140	112	3556.000	5.83	N	
1600-XXH-300	9277-54084	128	4064.000	5.13	N	
1800-XXH-300	9257-05207	144	4572.000	5.04	N	

XXH - 1.1/4" - 1.250"						
31.75 MM PITCH - 4,00" - 101.6 MM WIDE						
Item description	Product Number	Teeth	Pitch Length (mm)	Weight (kg)	Stock	
700-XXH-400	9257-05300	56	1778.000	3.18	N	
800-XXH-400	9257-05301	64	2032.000	3.61	N	
900-XXH-400	9257-05302	72	2286.000	4.08	N	
1000-XXH-400	9257-05303	80	2540.000	4.40	N	
1200-XXH-400	9257-05304	96	3048.000	5.26	N	
1400-XXH-400	9277-53301	112	3556.000	7.77	N	
1600-XXH-400	9257-05306	128	4064.000	7.03	N	
1800-XXH-400	9257-05307	144	4572.000	7.85	N	

POWERGRIP



POWERGRIP TIMING BELTS AND SLABS - MXL, XL, L, H, XH, XXH

XXH - 1.1/4" - 1.250"					
31.75 MM PITCH - 5,00" - 127 MM WIDE					
Item description	Product Number	Teeth	Pitch Length (mm)	Weight (kg)	Stock
700-XXH-500	9257-05400	56	1778.000	3.97	N
800-XXH-500	9277-53698	64	2032.000	4.35	N
900-XXH-500	9257-05402	72	2286.000	4.90	N
1000-XXH-500	9257-05403	80	2540.000	5.44	N
1200-XXH-500	9257-05404	96	3048.000	6.35	N
1400-XXH-500	9257-64140	112	3556.000	9.48	N
1600-XXH-500	9257-05406	128	4064.000	8.19	N
1800-XXH-500	9257-05407	144	4572.000	9.14	N

XXH - 1.1/4" - 1.250" PITCH						
SLABS						
Item description	Product Number	Teeth	Pitch Length (mm)	Weight (kg)	Stock	Width (inch)
700-XXH	9254-53199	56	1778.000	10.92	N	13
800-XXH	9254-09501	64	2032.000	14.40	N	15
900-XXH	9254-09502	72	2286.000	16.20	N	15
1000-XXH	9254-09503	80	2540.000	18.75	N	15
1200-XXH	9257-17104	96	3048.000	19.15	N	14
1400-XXH	9254-53296	112	3556.000	26.64	N	13
1600-XXH	9254-53195	128	4064.000	24.96	N	13
1800-XXH	9254-08907	144	4572.000	32.40	N	13



POWERPAINT POWERGRIP SLABS - 8M AND 14M

Recommended Sprockets

PowerGrip HTD Sprockets

NOTES: 8M and 14M PowerPaint PowerGrip HTD, GT4 and GTX products have identical characteristics as the standard PowerGrip product, but are specifically designed for use in painting areas. Belt pitch is the distance in millimeters between two adjacent tooth centers as measured on the pitch line of the belt. Belt pitch length is the total length (circumference) in millimeters as measured along the pitch line. The theoretical pitch line of a PowerPaint PowerGrip product lies within the tensile member. PowerPaint PowerGrip part numbers are comprised of the execution, pitch length and pitch. For example, part number PPT-1160-8MGT4 denotes PPT=PowerPaint version, a 1160mm pitch length, 8mm pitch, corresponding slab width can be found using the below table. Synchronous pitch length is always a multiple of the belt pitch.

Item description build up: PPT-length-pitch-width

Minmum Order Quantity = 2 slabs

TABLE POWERPAINT BELTS					
Minimum Order Quantity (indicative)					
Slab	8M			14M	
	Belt width (mm)				
Width (in)	20	30	50	40	55
13	34	22	14	16	12
18	48	32	18	On request	
28	72	48	28		



POWERPAINT POWERGRIP SLABS - 8M AND 14M

POWERPAINT
POWERGRIP

POWERGRIP GTX - 8MM PITCH - SLABS							
Item description	Product Number	Teeth	Pitch Length (mm)	Weight (kg)	Stock	Width (inch)	Tooth profile
PPT-264-8MX	9326-51094	33	264	0.933	N	18	HTD
PPT-320-8MX	9326-51095	40	320	1.644	N	28	HTD
PPT-376-8MX	9326-51096	47	376	1.100	N	18	HTD
PPT-384-8MX	9326-51097	48	384	1.736	N	28	GT
PPT-424-8MX	9326-51189	53	424	1.929	N	28	HTD
PPT-472-8MX	9326-51190	59	472	2.147	N	28	GT
PPT-480-8MX	9326-51099	60	480	2.116	N	28	HTD
PPT-512-8MX	9326-51100	64	512	2.249	N	28	HTD
PPT-520-8MX	9326-51101	65	520	1.521	N	18	HTD
PPT-560-8MX	9326-51102	70	560	2.449	N	28	HTD
PPT-576-8MX	9326-51103	72	576	1.685	N	18	HTD
PPT-600-8MX	9326-51104	75	600	2.560	N	28	GT
PPT-608-8MX	9326-51105	76	608	1.778	N	18	HTD
PPT-624-8MX	9326-51106	78	624	2.839	N	28	HTD
PPT-640-8MX	9326-51107	80	640	2.783	N	28	HTD
PPT-656-8MX	9326-51191	82	656	2.985	N	28	HTD
PPT-720-8MX	9326-51109	90	720	3.116	N	28	HTD
PPT-760-8MX	9326-51192	95	760	2.233	N	18	HTD
PPT-776-8MX	9326-51111	97	776	2.246	N	18	HTD
PPT-800-8MX	9326-51112	100	800	2.259	N	18	GT
PPT-840-8MX	9326-51113	105	840	2.212	N	18	GT
PPT-856-8MX	9326-51114	107	856	2.505	N	18	HTD
PPT-880-8MX	9326-51115	110	880	2.209	N	18	GT
PPT-912-8MX	9326-51116	114	912	3.990	N	28	HTD
PPT-920-8MX	9326-51117	115	920	2.650	N	18	GT
PPT-960-8MX	9326-51118	120	960	2.696	N	18	GT
PPT-968-8MX	9326-51119	121	968	4.405	N	28	HTD
PPT-976-8MX	9326-51193	122	976	2.855	N	18	HTD
PPT-1000-8MX	9326-51194	125	1000	2.925	N	18	HTD
PPT-1040-8MX	9326-51122	130	1040	4.732	N	18	HTD
PPT-1064-8MX	9326-51123	133	1064	3.112	N	18	HTD
PPT-1080-8MX	9326-51195	135	1080	3.159	N	18	HTD
PPT-1120-8MX	9326-51125	140	1120	3.134	N	18	GT
PPT-1128-8MX	9326-51126	141	1128	3.231	N	18	HTD
PPT-1160-8MX	9326-51127	145	1160	3.320	N	18	HTD
PPT-1176-8MX	9326-51128	147	1176	5.351	N	28	HTD
PPT-1200-8MX	9326-51129	150	1200	3.353	N	18	GT
PPT-1216-8MX	9326-51130	152	1216	3.542	N	18	HTD
PPT-1224-8MX	9326-51131	153	1224	5.219	N	28	HTD
PPT-1256-8MX	9326-51132	157	1256	5.352	N	28	HTD
PPT-1264-8MX	9326-51196	158	1264	3.611	N	18	HTD
PPT-1280-8MX	9326-51134	160	1280	3.616	N	18	GT
PPT-1304-8MX	9326-51135	163	1304	5.552	N	28	HTD
PPT-1360-8MX	9326-51197	170	1360	3.879	N	18	HTD
PPT-1424-8MX	9326-51137	178	1424	4.058	N	18	HTD

POWERGRIP GTX - 8MM PITCH - SLABS							
Item description	Product Number	Teeth	Pitch Length (mm)	Weight (kg)	Stock	Width (inch)	Tooth profile
PPT-1432-8MX	9326-51138	179	1432	4.080	N	18	HTD
PPT-1440-8MX	9326-51139	180	1440	4.058	N	18	GT
PPT-1512-8MX	9326-51140	189	1512	4.148	N	18	GT
PPT-1520-8MX	9326-51141	190	1520	4.445	N	18	HTD
PPT-1552-8MX	9326-51198	194	1552	4.539	N	18	HTD
PPT-1584-8MX	9326-51143	198	1584	4.343	N	18	GT
PPT-1600-8MX	9326-51144	200	1600	4.387	N	18	GT
PPT-1696-8MX	9326-51199	212	1696	4.960	N	18	HTD
PPT-1728-8MX	9326-51146	216	1728	7.863	N	28	HTD
PPT-1760-8MX	9326-51147	220	1760	4.851	N	18	GT
PPT-1800-8MX	9326-51148	225	1800	5.185	N	18	GT
PPT-1880-8MX	9326-51200	235	1880	5.415	N	18	HTD
PPT-1896-8MX	9326-51201	237	1896	5.545	N	18	HTD
PPT-1904-8MX	9326-51151	238	1904	5.569	N	18	HTD
PPT-2000-8MX	9326-51188	250	2000	9.103	N	28	HTD
PPT-2080-8MX	9326-51202	260	2080	4.393	N	13	HTD
PPT-2200-8MX	9326-51154	275	2200	4.580	N	13	HTD
PPT-2240-8MX	9326-51155	280	2240	4.731	N	13	HTD
PPT-2272-8MX	9326-51156	284	2272	4.798	N	13	HTD
PPT-2400-8MX	9326-51157	300	2400	4.826	N	13	HTD
PPT-2504-8MX	9326-51158	313	2504	5.209	N	13	HTD
PPT-2600-8MX	9326-51159	325	2600	5.491	N	13	HTD
PPT-2800-8MX	9326-51160	350	2800	5.914	N	13	HTD
PPT-3048-8MX	9326-51161	381	3048	5.797	N	13	GT
PPT-3280-8MX	9326-51162	410	3280	6.238	N	13	GT
PPT-3600-8MX	9326-51163	450	3600	6.847	N	13	GT
PPT-4400-8MX	9326-51164	550	4400	8.369	N	13	GT



POWERPAINT POWERGRIP SLABS - 8M AND 14M

POWERPAINT
POWERGRIP

POWERGRIP GTX - 14MM PITCH - SLABS							
Item description	Product Number	Teeth	Pitch Length (mm)	Weight (kg)	Stock	Width (inch)	Tooth profile
PPT-784-14MX	9326-51165	56	784	4.031	N	18	HTD
PPT-826-14MX	9326-51166	59	826	4.106	N	18	HTD
PPT-924-14MX	9326-51167	66	924	4.571	N	18	HTD
PPT-966-14MX	9326-51168	69	966	4.282	N	18	HTD
PPT-1092-14MX	9326-51169	78	1092	4.481	N	18	HTD
PPT-1190-14MX	9326-51170	85	1190	3.858	N	13	GT
PPT-1400-14MX	9326-51171	100	1400	4.539	N	13	GT
PPT-1610-14MX	9326-51203	115	1610	5.156	N	13	GT
PPT-1750-14MX	9326-51173	125	1750	5.605	N	13	GT
PPT-1778-14MX	9326-51174	127	1778	5.765	N	13	GT
PPT-1890-14MX	9326-51175	135	1890	6.128	N	13	GT
PPT-2100-14MX	9326-51176	150	2100	6.809	N	13	GT
PPT-2310-14MX	9326-51204	165	2310	7.394	N	13	GT
PPT-2450-14MX	9326-51178	175	2450	7.842	N	13	HTD
PPT-2590-14MX	9326-51179	185	2590	8.291	N	14	HTD
PPT-2800-14MX	9326-51180	200	2800	9.084	N	13	GT
PPT-3150-14MX	9326-51181	225	3150	10.089	N	13	GT
PPT-3500-14MX	9326-51182	250	3500	11.355	N	13	GT
PPT-3850-14MX	9326-51183	275	3850	12.483	N	13	GT
PPT-4004-14MX	9326-51205	286	4004	12.817	N	13	GT
PPT-4326-14MX	9326-51185	309	4326	14.026	N	13	GT
PPT-4578-14MX	9326-51186	327	4578	14.654	N	13	HTD

POWERGRIP GT4 - 8MM PITCH - SLABS							
Item description	Product Number	Teeth	Pitch Length (mm)	Weight (kg)	Stock	Width (inch)	
PPT-384-8MGT4	9577-50002	48	384	1.325	N	28	
PPT-424-8MGT4	9577-50071	53	424	1.463	N	28	
PPT-472-8MGT4	9577-50072	59	472	1.629	N	28	
PPT-480-8MGT4	9577-50003	60	480	1.656	N	28	
PPT-560-8MGT4	9577-50004	70	560	1.932	N	28	
PPT-600-8MGT4	9577-50005	75	600	2.070	N	28	
PPT-640-8MGT4	9577-50006	80	640	2.208	N	28	
PPT-656-8MGT4	9577-50073	82	656	2.264	N	28	
PPT-720-8MGT4	9577-50007	90	720	2.484	N	28	
PPT-760-8MGT4	9577-50074	95	760	1.686	N	18	
PPT-800-8MGT4	9577-50008	100	800	1.774	N	18	
PPT-840-8MGT4	9577-50067	105	840	1.863	N	18	
PPT-880-8MGT4	9577-50010	110	880	1.952	N	18	
PPT-920-8MGT4	9577-50011	115	920	2.041	N	18	
PPT-960-8MGT4	9577-50012	120	960	2.129	N	18	
PPT-976-8MGT4	9577-50075	122	976	2.165	N	18	
PPT-1000-8MGT4	9577-50076	125	1000	2.218	N	18	
PPT-1040-8MGT4	9577-50013	130	1040	2.307	N	18	
PPT-1064-8MGT4	9577-50069	133	1064	2.360	N	18	
PPT-1080-8MGT4	9577-50077	135	1080	2.396	N	18	
PPT-1120-8MGT4	9577-50014	140	1120	2.484	N	18	
PPT-1160-8MGT4	9577-50070	145	1160	2.573	N	18	
PPT-1200-8MGT4	9577-50015	150	1200	2.661	N	18	
PPT-1264-8MGT4	9577-50078	158	1264	2.804	N	18	
PPT-1280-8MGT4	9577-50016	160	1280	2.839	N	18	
PPT-1360-8MGT4	9577-50079	170	1360	3.017	N	18	
PPT-1440-8MGT4	9577-50017	180	1440	3.194	N	18	
PPT-1512-8MGT4	9577-50018	189	1512	3.353	N	18	
PPT-1552-8MGT4	9577-50080	194	1552	3.443	N	18	
PPT-1584-8MGT4	9577-50019	198	1584	3.513	N	18	
PPT-1600-8MGT4	9577-50020	200	1600	3.548	N	18	
PPT-1696-8MGT4	9577-50081	212	1696	3.762	N	18	
PPT-1760-8MGT4	9577-50021	220	1760	3.903	N	18	
PPT-1800-8MGT4	9577-50022	225	1800	3.992	N	18	
PPT-1880-8MGT4	9577-50082	235	1880	4.170	N	18	
PPT-1896-8MGT4	9577-50083	237	1896	4.206	N	18	
PPT-2000-8MGT4	9577-50023	250	2000	3.203	N	13	
PPT-2080-8MGT4	9577-50084	260	2080	3.332	N	13	
PPT-2400-8MGT4	9577-50024	300	2400	3.844	N	13	
PPT-2600-8MGT4	9577-50025	325	2600	4.164	N	13	
PPT-2800-8MGT4	9577-50026	350	2800	4.485	N	13	
PPT-3048-8MGT4	9577-50027	381	3048	4.882	N	13	
PPT-3280-8MGT4	9577-50028	410	3280	5.253	N	13	
PPT-3600-8MGT4	9577-50029	450	3600	5.766	N	13	
PPT-4400-8MGT4	9577-50030	550	4400	12.350	N	13	



POWERPAINT POWERGRIP SLABS - 8M AND 14M

POWERPAINT
POWERGRIP

POWERGRIP GT4 - 14MM PITCH - SLABS						
Item description	Product Number	Teeth	Pitch Length (mm)	Weight (kg)	Stock	Width (inch)
PPT-1190-14MGT4	9577-50033	85	1190	3.340	N	13
PPT-1400-14MGT4	9577-50035	100	1400	3.930	N	13
PPT-1610-14MGT4	9577-50085	115	1610	4.520	N	13
PPT-1750-14MGT4	9577-50068	125	1750	4.912	N	13
PPT-1778-14MGT4	9577-50036	127	1778	4.991	N	13
PPT-1890-14MGT4	9577-50066	135	1890	5.305	N	13
PPT-2100-14MGT4	9577-50034	150	2100	5.895	N	13
PPT-2310-14MGT4	9577-50086	165	2310	6.485	N	13
PPT-2800-14MGT4	9577-50032	200	2800	7.859	N	13
PPT-3150-14MGT4	9577-50040	225	3150	8.842	N	13
PPT-3500-14MGT4	9577-50065	250	3500	9.824	N	13
PPT-3850-14MGT4	9577-59011	275	3850	10.806	N	13
PPT-4004-14MGT4	9577-50087	286	4004	11.240	N	13
PPT-4326-14MGT4	9577-50041	309	4326	12.142	N	13

POWERGRIP HTD - 5MM PITCH - SLABS						
Item description	Product Number	Teeth	Pitch Length (mm)	Weight (kg)	Stock	Width (inch)
PPT-500-5M	9296-51712	100	500	1.386	N	28
PPT-635-5M	9296-51586	127	635	1.761	N	28
PPT-640-5M	9296-51582	128	640	1.775	N	28
PPT-670-5M	9296-51704	134	670	1.858	N	28
PPT-700-5M	9296-51650	140	700	1.941	N	28
PPT-720-5M	9296-51707	144	720	1.996	N	28
PPT-775-5M	9296-51701	155	775	2.149	N	28
PPT-800-5M	9296-51706	160	800	2.218	N	28

POWERGRIP HTD - 8MM PITCH - SLABS						
Item description	Product Number	Teeth	Pitch Length (mm)	Weight (kg)	Stock	Width (inch)
PPT-384-8M	9296-51550	48	384	1.747	N	28
PPT-480-8M	9296-51546	60	480	2.184	N	28
PPT-560-8M	9296-51471	70	560	2.548	N	28
PPT-600-8M	9296-51539	75	600	2.730	N	28
PPT-640-8M	9296-51472	80	640	2.912	N	28
PPT-720-8M	9296-51475	90	720	3.276	N	28
PPT-800-8M	9296-51473	100	800	3.640	N	28
PPT-880-8M	9296-51608	110	880	2.534	N	18
PPT-960-8M	9296-51476	120	960	4.368	N	28
PPT-1000-8M	9296-51685	125	1000	4.481	N	28
PPT-1040-8M	9296-51477	130	1040	4.732	N	28
PPT-1120-8M	9296-51478	140	1120	5.096	N	28
PPT-1160-8M	9296-51694	145	1160	3.320	N	18
PPT-1200-8M	9296-51479	150	1200	5.460	N	28
PPT-1280-8M	9296-51480	160	1280	5.825	N	28
PPT-1360-8M	9296-51551	170	1360	3.978	N	18
PPT-1440-8M	9296-51610	180	1440	4.147	N	18
PPT-1600-8M	9296-51482	200	1600	4.680	N	18
PPT-1760-8M	9296-51483	220	1760	5.148	N	18
PPT-1800-8M	9296-51568	225	1800	8.065	N	28
PPT-2000-8M	9296-55449	250	2000	9.103	N	28
PPT-2080-8M	9296-51663	260	2080	4.327	N	13
PPT-2240-8M	9296-51487	280	2240	4.731	N	13
PPT-2400-8M	9296-51486	300	2400	5.069	N	13
PPT-2600-8M	9296-51612	325	2600	5.410	N	13
PPT-2800-8M	9296-51488	350	2800	5.914	N	13

POWERGRIP HTD - 14MM PITCH - SLABS						
Item description	Product Number	Teeth	Pitch Length (mm)	Weight (kg)	Stock	Width (inch)
PPT-1890-14M	9296-51662	135	1890	6.132	N	13
PPT-2100-14M	9296-51660	150	2100	6.813	N	13
PPT-2800-14M	9296-51592	200	2800	9.084	N	13
PPT-4326-14M	9296-51661	309	4326	14.034	N	13



TWIN POWER POWERGRIP GT2 BELTS AND SLABS 8MGT AND BELTS 14MGT

Recommended Sprockets

PowerGrip HTD Sprockets

NOTES: Belt pitch is the distance in millimeters between two adjacent tooth centers as measured on the pitch line of the belt. Belt pitch length is the total length (circumference) in millimeters as measured along the pitch line. The theoretical pitch line of a PowerGrip GT2 Twin Power belt lies within the tensile member. If you currently use Twin Power PowerGrip HTD belts, consider Twin Power PowerGrip GT2 belts at reduced widths to lower your costs. Twin Power PowerGrip GT2 part numbers are comprised of pitch length, pitch and width. For example; part number TP-4400-8MGT-30 denotes a "TP" for Twin Power, 4400mm pitch length, 8mm pitch and 30mm width. Synchronous pitch length is always a multiple of the belt pitch.

Item description build up: TP-length-pitch-width

8MM PITCH - 20 MM WIDE					
Item description	Product Number	Teeth	Pitch Length (mm)	Weight (kg)	Stock
TP-480-8MGT2-20	9232-50185	60	480	0.079	Y
TP-560-8MGT2-20	9232-50190	70	560	0.092	Y
TP-600-8MGT2-20	9232-50195	75	600	0.098	Y
TP-640-8MGT2-20	9232-50200	80	640	0.105	Y
TP-720-8MGT2-20	9232-50205	90	720	0.118	Y
TP-800-8MGT2-20	9232-50021	100	800	0.131	Y
TP-880-8MGT2-20	9232-50025	110	880	0.144	Y
TP-960-8MGT2-20	9232-50029	120	960	0.157	Y
TP-1040-8MGT2-20	9232-50033	130	1040	0.170	Y
TP-1120-8MGT2-20	9232-50037	140	1120	0.183	Y
TP-1200-8MGT2-20	9232-50041	150	1200	0.197	Y
TP-1280-8MGT2-20	9232-50045	160	1280	0.210	Y
TP-1440-8MGT2-20	9232-50049	180	1440	0.236	Y
TP-1600-8MGT2-20	9232-50053	200	1600	0.262	Y
TP-1760-8MGT2-20	9232-50057	220	1760	0.288	Y
TP-1800-8MGT2-20	9232-50061	225	1800	0.295	Y
TP-2000-8MGT2-20	9232-50065	250	2000	0.328	Y
TP-2400-8MGT2-20	9232-50069	300	2400	0.393	Y
TP-2600-8MGT2-20	9232-50077	325	2600	0.426	Y
TP-2800-8MGT2-20	9232-50073	350	2800	0.459	Y
TP-3048-8MGT2-20	9232-50081	381	3048	0.499	Y
TP-3280-8MGT2-20	9232-50085	410	3280	0.537	Y
TP-3600-8MGT2-20	9232-50089	450	3600	0.590	Y
TP-4400-8MGT2-20	9232-50093	550	4400	0.721	Y
TP-4960-8MGT2-20	9232-02015	620	4960	0.812	N

8MM PITCH - 30 MM WIDE					
Item description	Product Number	Teeth	Pitch Length (mm)	Weight (kg)	Stock
TP-480-8MGT2-30	9232-50186	60	480	0.118	Y
TP-560-8MGT2-30	9232-50191	70	560	0.138	Y
TP-600-8MGT2-30	9232-50196	75	600	0.147	Y
TP-640-8MGT2-30	9232-50201	80	640	0.157	Y
TP-720-8MGT2-30	9232-50206	90	720	0.177	Y
TP-800-8MGT2-30	9232-50022	100	800	0.197	Y
TP-880-8MGT2-30	9232-50026	110	880	0.216	Y
TP-960-8MGT2-30	9232-50030	120	960	0.236	Y
TP-1040-8MGT2-30	9232-50034	130	1040	0.256	Y
TP-1120-8MGT2-30	9232-50038	140	1120	0.275	Y
TP-1200-8MGT2-30	9232-50042	150	1200	0.295	Y
TP-1280-8MGT2-30	9232-50046	160	1280	0.314	Y
TP-1440-8MGT2-30	9232-50050	180	1440	0.354	Y
TP-1600-8MGT2-30	9232-50054	200	1600	0.393	Y
TP-1760-8MGT2-30	9232-50058	220	1760	0.432	Y
TP-1800-8MGT2-30	9232-50062	225	1800	0.442	Y
TP-2000-8MGT2-30	9232-50066	250	2000	0.491	Y
TP-2400-8MGT2-30	9232-50070	300	2400	0.590	Y
TP-2600-8MGT2-30	9232-50078	325	2600	0.639	Y
TP-2800-8MGT2-30	9232-50074	350	2800	0.688	Y
TP-3048-8MGT2-30	9232-50082	381	3048	0.749	Y
TP-3280-8MGT2-30	9232-50086	410	3280	0.806	Y
TP-3600-8MGT2-30	9232-50090	450	3600	0.885	Y
TP-4400-8MGT2-30	9232-50094	550	4400	1.081	Y
TP-4960-8MGT2-30	9232-02016	620	4960	1.219	N

TWIN POWER POWERGRIP GT2 BELTS AND SLABS 8MGT AND BELTS 14MGT

8MM PITCH - 50 MM WIDE					
Item description	Product Number	Teeth	Pitch Length (mm)	Weight (kg)	Stock
TP-480-8MGT2-50	9232-50187	60	480	0.197	Y
TP-560-8MGT2-50	9232-50192	70	560	0.229	Y
TP-600-8MGT2-50	9232-50197	75	600	0.246	Y
TP-640-8MGT2-50	9232-50202	80	640	0.262	Y
TP-720-8MGT2-50	9232-50207	90	720	0.295	Y
TP-800-8MGT2-50	9232-50023	100	800	0.328	Y
TP-880-8MGT2-50	9232-50027	110	880	0.360	Y
TP-960-8MGT2-50	9232-50031	120	960	0.393	Y
TP-1040-8MGT2-50	9232-50035	130	1040	0.426	Y
TP-1120-8MGT2-50	9232-50039	140	1120	0.459	Y
TP-1200-8MGT2-50	9232-50043	150	1200	0.491	Y
TP-1280-8MGT2-50	9232-50047	160	1280	0.524	Y
TP-1440-8MGT2-50	9232-50051	180	1440	0.590	Y
TP-1600-8MGT2-50	9232-50055	200	1600	0.655	Y
TP-1760-8MGT2-50	9232-50059	220	1760	0.721	Y
TP-1800-8MGT2-50	9232-50063	225	1800	0.737	Y
TP-2000-8MGT2-50	9232-50067	250	2000	0.819	Y
TP-2400-8MGT2-50	9232-50071	300	2400	0.983	Y
TP-2600-8MGT2-50	9232-50079	325	2600	1.065	Y
TP-2800-8MGT2-50	9232-50075	350	2800	1.147	Y
TP-3048-8MGT2-50	9232-50083	381	3048	1.050	Y
TP-3280-8MGT2-50	9232-50087	410	3280	1.343	Y
TP-3600-8MGT2-50	9232-50091	450	3600	1.474	Y
TP-4400-8MGT2-50	9232-50095	550	4400	1.802	Y
TP-4960-8MGT2-50	9232-02017	620	4960	2.031	N

8MM PITCH - 85 MM WIDE					
Item description	Product Number	Teeth	Pitch Length (mm)	Weight (kg)	Stock
TP-480-8MGT2-85	9232-50188	60	480	0.334	Y
TP-560-8MGT2-85	9232-50193	70	560	0.390	Y
TP-600-8MGT2-85	9232-50198	75	600	0.418	Y
TP-640-8MGT2-85	9232-50203	80	640	0.446	Y
TP-720-8MGT2-85	9232-50208	90	720	0.501	Y
TP-800-8MGT2-85	9232-50024	100	800	0.557	Y
TP-880-8MGT2-85	9232-50028	110	880	0.613	Y
TP-960-8MGT2-85	9232-51008	120	960	0.668	Y
TP-1040-8MGT2-85	9232-50036	130	1040	0.724	Y
TP-1120-8MGT2-85	9232-50040	140	1120	0.780	Y
TP-1200-8MGT2-85	9232-50044	150	1200	0.835	Y
TP-1280-8MGT2-85	9232-50048	160	1280	0.891	Y
TP-1440-8MGT2-85	9232-50052	180	1440	1.002	Y
TP-1600-8MGT2-85	9232-50056	200	1600	1.114	Y
TP-1760-8MGT2-85	9232-50060	220	1760	1.225	Y
TP-1800-8MGT2-85	9232-50064	225	1800	1.253	Y
TP-2000-8MGT2-85	9232-50068	250	2000	1.392	Y
TP-2400-8MGT2-85	9232-50072	300	2400	1.671	Y
TP-2600-8MGT2-85	9232-50080	325	2600	1.810	Y
TP-2800-8MGT2-85	9232-50076	350	2800	1.949	Y
TP-3048-8MGT2-85	9232-50084	381	3048	2.122	Y
TP-3280-8MGT2-85	9232-50088	410	3280	2.283	Y
TP-3600-8MGT2-85	9232-50092	450	3600	2.506	Y
TP-4400-8MGT2-85	9232-50096	550	4400	3.063	N
TP-4960-8MGT2-85	9232-02018	620	4960	3.453	N



TWIN POWER POWERGRIP GT2 BELTS AND SLABS 8MGT AND BELTS 14MGT

8MM PITCH - SLABS						
Item description	Product Number	Teeth	Pitch Length (mm)	Weight (kg)	Stock	Width (mm)
TP-480-8MGT2	9232-50189	60	480	0.393	Y	100
TP-560-8MGT2	9232-50194	70	560	0.457	Y	100
TP-600-8MGT2	9232-50199	75	600	0.491	Y	100
TP-640-8MGT2	9232-50204	80	640	0.524	Y	100
TP-720-8MGT2	9232-50209	90	720	0.590	Y	100
TP-800-8MGT2	9232-50210	100	800	0.655	Y	100
TP-880-8MGT2	9232-50211	110	880	0.721	Y	100
TP-960-8MGT2	9232-50212	120	960	0.786	Y	100
TP-1040-8MGT2	9232-50213	130	1040	0.852	Y	100
TP-1120-8MGT2	9232-50214	140	1120	3.027	Y	330
TP-1200-8MGT2	9232-50215	150	1200	3.243	Y	330
TP-1280-8MGT2	9232-50216	160	1280	3.459	Y	330
TP-1440-8MGT2	9232-50217	180	1440	3.892	Y	330
TP-1600-8MGT2	9232-50218	200	1600	4.324	Y	330
TP-1760-8MGT2	9232-50219	220	1760	4.756	Y	330
TP-1800-8MGT2	9232-50220	225	1800	4.865	Y	330
TP-2000-8MGT2	9232-50221	250	2000	5.405	Y	330
TP-2400-8MGT2	9232-50222	300	2400	6.178	Y	330
TP-2600-8MGT2	9232-50223	325	2600	6.692	Y	330
TP-2800-8MGT2	9232-50224	350	2800	7.568	Y	330
TP-3048-8MGT2	9232-50225	381	3048	8.238	Y	330
TP-3280-8MGT2	9232-02033	410	3280	4.029	Y	150
TP-3600-8MGT2	9232-02034	450	3600	4.423	Y	150
TP-4400-8MGT2	9232-02031	550	4400	5.405	Y	150
TP-4960-8MGT2	9232-02019	620	4960	6.093	N	150

14MM PITCH - 40 MM WIDE					
Item description	Product Number	Teeth	Pitch Length (mm)	Weight (kg)	Stock
TP-1610-14MGT2-40	9232-50115	115	1610	0.823	Y
TP-1778-14MGT2-40	9232-50120	127	1778	0.908	N
TP-1890-14MGT2-40	9232-50125	135	1890	0.966	Y
TP-2100-14MGT2-40	9232-50130	150	2100	1.073	Y
TP-2310-14MGT2-40	9232-50135	165	2310	1.180	Y
TP-2450-14MGT2-40	9232-50140	175	2450	1.252	Y
TP-2590-14MGT2-40	9232-50145	185	2590	1.323	Y
TP-2800-14MGT2-40	9232-50150	200	2800	1.431	Y
TP-3150-14MGT2-40	9232-50155	225	3150	1.609	Y
TP-3360-14MGT2-40	9232-00180	240	3360	1.717	N
TP-3500-14MGT2-40	9232-50160	250	3500	1.788	Y
TP-3850-14MGT2-40	9232-50165	275	3850	1.967	N
TP-4326-14MGT2-40	9232-50170	309	4326	2.210	N
TP-4578-14MGT2-40	9232-50175	327	4578	2.339	N
TP-4956-14MGT2-40	9232-00185	354	4956	2.532	N
TP-5320-14MGT2-40	9232-00190	380	5320	2.718	N
TP-5740-14MGT2-40	9232-00195	410	5740	2.932	Y
TP-6160-14MGT2-40	9232-00200	440	6160	3.147	N
TP-6860-14MGT2-40	9232-00205	490	6860	3.505	N

TWIN POWER



TWIN POWER POWERGRIP GT2 BELTS AND SLABS 8MGT AND BELTS 14MGT

14MM PITCH - 55 MM WIDE					
Item description	Product Number	Teeth	Pitch Length (mm)	Weight (kg)	Stock
TP-1610-14MGT2-55	9232-50116	115	1610	1.131	Y
TP-1778-14MGT2-55	9232-50121	127	1778	1.249	N
TP-1890-14MGT2-55	9232-50126	135	1890	1.328	Y
TP-2100-14MGT2-55	9232-50131	150	2100	1.475	Y
TP-2310-14MGT2-55	9232-50136	165	2310	1.623	Y
TP-2450-14MGT2-55	9232-50141	175	2450	1.721	Y
TP-2590-14MGT2-55	9232-50146	185	2590	1.819	Y
TP-2800-14MGT2-55	9232-50151	200	2800	1.967	Y
TP-3150-14MGT2-55	9232-50156	225	3150	2.213	Y
TP-3360-14MGT2-55	9232-00181	240	3360	2.360	N
TP-3500-14MGT2-55	9232-50161	250	3500	2.459	Y
TP-3850-14MGT2-55	9232-50166	275	3850	2.705	N
TP-4326-14MGT2-55	9232-50171	309	4326	3.039	N
TP-4578-14MGT2-55	9232-50176	327	4578	3.216	N
TP-4956-14MGT2-55	9232-00186	354	4956	3.482	N
TP-5320-14MGT2-55	9232-00191	380	5320	3.737	N
TP-5740-14MGT2-55	9232-00196	410	5740	4.032	Y
TP-6160-14MGT2-55	9232-00201	440	6160	4.327	N
TP-6860-14MGT2-55	9232-00206	490	6860	4.819	N

14MM PITCH - 85 MM WIDE					
Item description	Product Number	Teeth	Pitch Length (mm)	Weight (kg)	Stock
TP-1610-14MGT2-85	9232-50117	115	1610	1.748	Y
TP-1778-14MGT2-85	9232-50122	127	1778	1.930	N
TP-1890-14MGT2-85	9232-50127	135	1890	2.052	Y
TP-2100-14MGT2-85	9232-50132	150	2100	2.280	Y
TP-2310-14MGT2-85	9232-50137	165	2310	2.508	Y
TP-2450-14MGT2-85	9232-50142	175	2450	2.660	Y
TP-2590-14MGT2-85	9232-50147	185	2590	2.812	Y
TP-2800-14MGT2-85	9232-50152	200	2800	3.040	Y
TP-3150-14MGT2-85	9232-50157	225	3150	3.420	Y
TP-3360-14MGT2-85	9232-00182	240	3360	3.648	N
TP-3500-14MGT2-85	9232-50162	250	3500	3.800	Y
TP-3850-14MGT2-85	9232-50167	275	3850	4.180	N
TP-4326-14MGT2-85	9232-50172	309	4326	4.697	N
TP-4578-14MGT2-85	9232-50177	327	4578	4.970	N
TP-4956-14MGT2-85	9232-00187	354	4956	5.381	N
TP-5320-14MGT2-85	9232-00192	380	5320	5.776	N
TP-5740-14MGT2-85	9232-00197	410	5740	6.232	Y
TP-6160-14MGT2-85	9232-00202	440	6160	6.688	N
TP-6860-14MGT2-85	9232-00207	490	6860	7.448	N

14MM PITCH - 115 MM WIDE					
Item description	Product Number	Teeth	Pitch Length (mm)	Weight (kg)	Stock
TP-1610-14MGT2-115	9232-50118	115	1610	2.365	Y
TP-1778-14MGT2-115	9232-50123	127	1778	2.612	N
TP-1890-14MGT2-115	9232-50128	135	1890	2.776	Y
TP-2100-14MGT2-115	9232-50133	150	2100	3.085	N
TP-2310-14MGT2-115	9232-50138	165	2310	3.393	Y
TP-2450-14MGT2-115	9232-50143	175	2450	3.599	Y
TP-2590-14MGT2-115	9232-50148	185	2590	3.804	Y
TP-2800-14MGT2-115	9232-50153	200	2800	4.113	Y
TP-3150-14MGT2-115	9232-50158	225	3150	4.627	Y
TP-3360-14MGT2-115	9232-00183	240	3360	4.935	N
TP-3500-14MGT2-115	9232-50163	250	3500	5.141	Y
TP-3850-14MGT2-115	9232-50168	275	3850	5.655	N
TP-4326-14MGT2-115	9232-50173	309	4326	6.354	N
TP-4578-14MGT2-115	9232-50178	327	4578	6.724	N
TP-4956-14MGT2-115	9232-00188	354	4956	7.280	N
TP-5320-14MGT2-115	9232-00193	380	5320	7.814	N
TP-5740-14MGT2-115	9232-00198	410	5740	8.431	Y
TP-6160-14MGT2-115	9232-00203	440	6160	9.048	N
TP-6860-14MGT2-115	9232-00208	490	6860	10.076	N

14MM PITCH - 170 MM WIDE					
Item description	Product Number	Teeth	Pitch Length (mm)	Weight (kg)	Stock
TP-1610-14MGT2-170	9232-50119	115	1610	3.496	Y
TP-1778-14MGT2-170	9232-50124	127	1778	3.861	N
TP-1890-14MGT2-170	9232-50129	135	1890	4.104	Y
TP-2100-14MGT2-170	9232-50134	150	2100	4.560	Y
TP-2310-14MGT2-170	9232-50139	165	2310	4.952	Y
TP-2450-14MGT2-170	9232-50144	175	2450	5.320	Y
TP-2590-14MGT2-170	9232-50149	185	2590	5.624	Y
TP-2800-14MGT2-170	9232-50154	200	2800	6.080	Y
TP-3150-14MGT2-170	9232-50159	225	3150	6.840	Y
TP-3360-14MGT2-170	9232-00184	240	3360	7.296	N
TP-3500-14MGT2-170	9232-50164	250	3500	7.600	Y
TP-3850-14MGT2-170	9232-50169	275	3850	8.640	N
TP-4326-14MGT2-170	9232-50174	309	4326	9.393	N
TP-4578-14MGT2-170	9232-50179	327	4578	9.940	N
TP-4956-14MGT2-170	9232-00189	354	4956	10.761	N
TP-5320-14MGT2-170	9232-00194	380	5320	11.551	N
TP-5740-14MGT2-170	9232-00199	410	5740	12.463	Y
TP-6160-14MGT2-170	9232-00204	440	6160	13.375	N
TP-6860-14MGT2-170	9232-00209	490	6860	14.895	N

TWIN POWER



TWIN POWER POWERGRIP HTD BELTS AND SLABS - 5M

Recommended Sprockets

PowerGrip HTD Sprockets

NOTES: Belt pitch is the distance in millimeters between two adjacent tooth centers as measured on the pitch line of the belt. Belt pitch length is the total length (circumference) in millimeters as measured along the pitch line. The theoretical pitch line of a Twin Power PowerGrip HTD belt lies within the tensile member. If you currently use PowerGrip HTD Twin Power belts, consider PowerGrip GT2 Twin Power belts at reduced widths to lower your costs. Twin Power PowerGrip HTD part numbers are comprised of pitch length, pitch and width. For example; part number TP-700-5M-930 denotes a "TP" for Twin Power, 700mm pitch length, 5mm pitch and 9mm width. Synchronous pitch length is always a multiple of the belt pitch.

5MM PITCH - 9 MM WIDE					
Item description	Product Number	Teeth	Pitch Length (mm)	Weight (kg)	Stock
TP-425-5M-9	9297-00012	85	425	0.026	Y
TP-475-5M-9	9252-00505	95	475	0.044	N
TP-500-5M-9	9297-50095	100	500	0.023	N
TP-600-5M-9	9297-50108	120	600	0.027	Y
TP-615-5M-9	9297-50338	123	615	0.028	Y
TP-640-5M-9	9297-50122	128	640	0.029	N
TP-670-5M-9	9297-50128	134	670	0.031	N
TP-700-5M-9	9297-50133	140	700	0.032	N
TP-755-5M-9	9297-50137	151	755	0.034	N
TP-800-5M-9	9297-50144	160	800	0.037	N
TP-835-5M-9	9297-50147	167	835	0.046	Y
TP-890-5M-9	9297-50151	178	890	0.041	N
TP-925-5M-9	9297-50679	185	925	0.032	Y
TP-935-5M-9	9297-50155	187	935	0.045	Y
TP-1100-5M-9	9297-90083	220	1100	0.053	Y
TP-1200-5M-9	9297-50172	240	1200	0.058	Y
TP-1270-5M-9	9252-00522	254	1270	0.054	Y
TP-1420-5M-9	9297-00778	284	1420	0.060	Y
TP-1595-5M-9	9297-50402	319	1595	0.250	Y
TP-1690-5M-9	9252-00525	338	1690	0.071	Y
TP-1870-5M-9	9297-50635	374	1870	0.085	N
TP-1945-5M-9	9297-00588	389	1945	0.174	N
TP-2000-5M-9	9252-00528	400	2000	0.085	N
TP-2100-5M-9	9297-50180	420	2100	0.097	N
TP-2250-5M-9	9252-00529	450	2250	0.096	N
TP-2350-5M-9	9297-50636	470	2350	0.107	N
TP-2525-5M-9	9297-00779	505	2525	0.114	N

5MM PITCH - 15 MM WIDE					
Item description	Product Number	Teeth	Pitch Length (mm)	Weight (kg)	Stock
TP-425-5M-15	9297-00508	85	425	0.060	Y
TP-475-5M-15	9252-00536	95	475	0.073	Y
TP-500-5M-15	9297-50096	100	500	0.038	Y
TP-600-5M-15	9297-50109	120	600	0.046	Y
TP-615-5M-15	9297-50116	123	615	0.047	Y
TP-640-5M-15	9297-50123	128	640	0.049	N
TP-670-5M-15	9297-50129	134	670	0.051	N
TP-700-5M-15	9297-50135	140	700	0.053	N
TP-755-5M-15	9297-50138	151	755	0.057	N
TP-800-5M-15	9297-90034	160	800	0.061	N
TP-835-5M-15	9297-50148	167	835	0.064	Y
TP-890-5M-15	9297-50152	178	890	0.068	N
TP-925-5M-15	9297-50680	185	925	0.054	Y
TP-935-5M-15	9297-50154	187	935	0.071	Y
TP-1100-5M-15	9297-90065	220	1100	0.084	Y
TP-1200-5M-15	9297-50173	240	1200	0.097	Y
TP-1270-5M-15	9297-00782	254	1270	0.088	Y
TP-1420-5M-15	9252-00554	284	1420	0.101	Y
TP-1595-5M-15	9297-50429	319	1595	0.121	Y
TP-1690-5M-15	9297-00794	338	1690	0.120	Y
TP-1870-5M-15	9297-50179	374	1870	0.141	N
TP-1945-5M-15	9297-00214	389	1945	0.137	Y
TP-2000-5M-15	9297-01030	400	2000	0.136	N
TP-2100-5M-15	9297-50181	420	2100	0.156	N
TP-2250-5M-15	9297-00876	450	2250	0.154	N
TP-2350-5M-15	9297-50183	470	2350	0.175	N
TP-2525-5M-15	9252-00561	505	2525	0.172	N

TWIN POWER

TWIN POWER POWERGRIP HTD BELTS AND SLABS - 5M

5MM PITCH - 25 MM WIDE						5MM PITCH - SLABS						
Item description	Product Number	Teeth	Pitch Length (mm)	Weight (kg)	Stock	Item description	Product Number	Teeth	Pitch Length (mm)	Weight (kg)	Stock	Width (mm)
TP-425-5M-25	9271-04002	85	425	0.018	Y	TP-425-5M	9297-00507	85	425	0.651	Y	150
TP-475-5M-25	9297-00848	95	475	0.050	N	TP-475-5M	9297-10619	95	475	0.729	N	150
TP-500-5M-25	9297-50097	100	500	0.063	N	TP-500-5M	9249-50071	100	500	0.253	N	100
TP-600-5M-25	9297-50110	120	600	0.076	Y	TP-600-5M	9249-50009	120	600	0.304	Y	100
TP-615-5M-25	9297-90053	123	615	0.103	Y	TP-615-5M	9249-50010	123	615	0.312	Y	100
TP-640-5M-25	9297-50124	128	640	0.081	N	TP-640-5M	9249-50049	128	640	0.324	N	100
TP-670-5M-25	9297-50130	134	670	0.085	N	TP-670-5M	9249-50079	134	670	0.340	N	100
TP-700-5M-25	9297-50136	140	700	0.089	N	TP-700-5M	9249-50050	140	700	0.355	N	100
TP-755-5M-25	9297-50139	151	755	0.096	N	TP-755-5M	9249-50051	151	755	0.383	N	100
TP-800-5M-25	9297-90031	160	800	0.101	N	TP-800-5M	9249-50072	160	800	0.406	N	100
TP-835-5M-25	9297-50149	167	835	0.106	Y	TP-835-5M	9249-50011	167	835	0.423	Y	100
TP-890-5M-25	9297-90057	178	890	0.113	N	TP-890-5M	9249-50086	178	890	0.451	N	100
TP-925-5M-25	9297-50681	185	925	0.090	Y	TP-925-5M	9249-50165	185	925	0.433	Y	120
TP-935-5M-25	9297-90071	187	935	0.119	Y	TP-935-5M	9249-50001	187	935	0.545	Y	120
TP-1100-5M-25	9297-90052	220	1100	0.161	Y	TP-1100-5M	9249-50043	220	1100	0.669	Y	120
TP-1200-5M-25	9297-90072	240	1200	0.152	Y	TP-1200-5M	9249-50012	240	1200	0.730	Y	120
TP-1270-5M-25	9252-00584	254	1270	0.314	Y	TP-1270-5M	9249-50163	254	1270	0.773	Y	120
TP-1420-5M-25	9252-00585	284	1420	0.164	Y	TP-1420-5M	9249-50162	284	1420	0.864	Y	120
TP-1595-5M-25	9297-50466	319	1595	0.202	Y	TP-1595-5M	9249-50013	319	1595	0.970	Y	130
TP-1690-5M-25	9297-00127	338	1690	1.000	Y	TP-1690-5M	9249-50164	338	1690	1.028	Y	120
TP-1870-5M-25	9297-50321	374	1870	0.237	N	TP-1870-5M	9249-50045	374	1870	1.138	N	120
TP-1945-5M-25	9297-00439	389	1945	0.232	Y	TP-1945-5M	9297-00277	389	1945	1.392	Y	150
TP-2000-5M-25	9297-00807	400	2000	0.230	N	TP-2000-5M	9297-00621	400	2000	1.518	N	150
TP-2100-5M-25	9297-50572	420	2100	0.266	N	TP-2100-5M	9249-50046	420	2100	1.384	N	130
TP-2250-5M-25	9297-00228	450	2250	0.256	N	TP-2250-5M	9297-00622	450	2250	1.536	N	150
TP-2350-5M-25	9297-50637	470	2350	0.298	N	TP-2350-5M	9249-50053	470	2350	1.549	N	130
TP-2525-5M-25	9297-00069	505	2525	2.895	N	TP-2525-5M	9297-00229	505	2525	3.754	N	150



TWIN POWER POWERGRIP XL, L, H TIMING BELTS AND SLABS

Recommended Sprockets PowerGrip Timing Sprockets

NOTES: Gates PowerGrip Twin Power Timing belt part numbers are comprised of pitch length, pitch and width. TP denotes Twin Power. Length - The length is shown in the first part of the belt designation. The first number is the pitch length in tenths of an inch. A TP-300-L-075 has a 30.0" or 762.0 mm pitch length. Pitch - The pitch of a PowerGrip Twin Power Timing belt is the distance from center to center of the teeth (in inches). It is shown in the second part of the belt designation by a letter or letters. Part number TP300L075 has a 0.375" or 9.525 mm. pitch. The letters correspond to pitches as follows: XL = Extra Light = 0.200" pitch; L = Light = 0.375" pitch; H = Heavy = 0.500" pitch. Width - The width is shown in the last part of the belt designation. Part number TP-300-L-075 is 0.75" or 19.05 mm. wide. Synchronous pitch length is always a multiple of the belt pitch.

XL - 1/5" - 0.200" - 5.08 MM PITCH					
1/4" - 6.40 MM WIDE					
Item description	Product Number	Teeth	Pitch Length (mm)	Weight (kg)	Stock
TP-150-XL-025	9246-01109	75	381.00	0.010	N
TP-160-XL-025	9246-01110	80	406.40	0.010	N
TP-170-XL-025	9246-01111	85	431.80	0.010	N
TP-180-XL-025	9246-01112	90	457.20	0.020	N
TP-190-XL-025	9246-11019	95	482.60	0.008	N
TP-200-XL-025	9246-11020	100	508.00	0.007	N
TP-210-XL-025	9246-01115	105	533.40	0.030	N
TP-220-XL-025	9246-01116	110	558.80	0.030	Y
TP-230-XL-025	9246-11023	115	584.20	0.009	N
TP-240-XL-025	9246-01118	120	609.60	0.030	N
TP-250-XL-025	9246-11025	125	635.00	0.009	N
TP-260-XL-025	9246-11026	130	660.40	0.008	Y
TP-280-XL-025	9246-11028	140	711.20	0.011	N
TP-290-XL-025	9246-50237	145	736.60	0.012	N
TP-300-XL-025	9246-11030	150	762.00	0.013	N
TP-310-XL-025	9246-11031	155	787.40	0.012	N
TP-348-XL-025	9246-50241	174	883.92	0.017	N
TP-352-XL-025	9246-50244	176	894.08	0.017	N

XL - 1/5" - 0.200" - 5.08 MM PITCH					
3/16" - 7.90 MM WIDE					
Item description	Product Number	Teeth	Pitch Length (mm)	Weight (kg)	Stock
TP-150-XL-031	9246-01209	75	381.00	0.025	N
TP-160-XL-031	9247-00253	80	406.40	0.012	N
TP-170-XL-031	9246-01211	85	431.80	0.028	N
TP-180-XL-031	9246-01212	90	457.20	0.030	N
TP-190-XL-031	9246-50228	95	482.60	0.012	N
TP-200-XL-031	9246-50229	100	508.00	0.013	N
TP-210-XL-031	9249-50230	105	533.40	0.011	N
TP-220-XL-031	9246-50231	110	558.80	0.013	Y
TP-230-XL-031	9246-50232	115	584.20	0.014	N
TP-240-XL-031	9246-50233	120	609.60	0.014	N
TP-250-XL-031	9246-50234	125	635.00	0.016	N
TP-260-XL-031	9246-50065	130	660.40	0.016	Y
TP-280-XL-031	9246-50226	140	711.20	0.017	N
TP-290-XL-031	9246-50238	145	736.60	0.018	N
TP-300-XL-031	9246-50239	150	762.00	0.018	N
TP-310-XL-031	9246-50240	155	787.40	0.019	N
TP-348-XL-031	9246-50242	174	883.92	0.022	N
TP-352-XL-031	9246-50245	176	894.08	0.022	N

TWIN POWER



TWIN POWER POWERGRIP XL, L, H TIMING BELTS AND SLABS

XL - 1/5" - 0.200" - 5.08 MM PITCH					
3/8" - 9.5 MM WIDE					
Item description	Product Number	Teeth	Pitch Length (mm)	Weight (kg)	Stock
TP-150-XL-037	9246-01309	75	381.00	0.030	N
TP-160-XL-037	9246-01310	80	406.40	1.000	N
TP-170-XL-037	9246-01311	85	431.80	0.030	N
TP-180-XL-037	9246-01312	90	457.20	0.030	N
TP-190-XL-037	9246-12019	95	482.60	0.011	N
TP-200-XL-037	9246-12020	100	508.00	0.012	N
TP-210-XL-037	9246-12021	105	533.40	0.013	N
TP-220-XL-037	9246-12022	110	558.80	0.013	Y
TP-230-XL-037	9246-12023	115	584.20	0.014	N
TP-240-XL-037	9246-12024	120	609.60	0.014	N
TP-250-XL-037	9246-12025	125	635.00	0.015	N
TP-260-XL-037	9246-12026	130	660.40	0.016	Y
TP-280-XL-037	9246-12028	140	711.20	0.017	N
TP-290-XL-037	9246-12029	145	736.60	0.017	N
TP-300-XL-037	9246-12030	150	762.00	0.018	N
TP-310-XL-037	9246-12031	155	787.40	0.019	N
TP-348-XL-037	9246-50243	174	883.92	0.026	N
TP-352-XL-037	9246-50246	176	894.08	0.026	N

XL - 1/5" - 0.200" - 5.08 MM PITCH						
SLABS						
Item description	Product Number	Teeth	Pitch Length (mm)	Weight (kg)	Stock	Width (mm)
TP-150-XL	9249-09109	75	381.00	0.068	N	130
TP-160-XL	9249-09110	80	406.40	0.068	N	130
TP-170-XL	9249-09111	85	431.80	0.073	N	130
TP-180-XL	9249-09112	90	457.20	0.073	N	130
TP-190-XL	9249-50108	95	482.60	0.125	N	100
TP-200-XL	9249-50002	100	508.00	0.132	N	100
TP-210-XL	9249-50126	105	533.40	0.139	N	100
TP-220-XL	9249-50038	110	558.80	0.145	Y	100
TP-230-XL	9249-50075	115	584.20	0.152	N	100
TP-240-XL	9249-50127	120	609.60	0.158	N	100
TP-250-XL	9249-50128	125	635.00	0.165	N	100
TP-260-XL	9249-50039	130	660.40	0.172	Y	100
TP-280-XL	9249-50118	140	711.20	0.185	N	100
TP-290-XL	9249-50129	145	736.60	0.192	N	100
TP-300-XL	9249-50068	150	762.00	0.198	N	100
TP-310-XL	9249-50090	155	787.40	0.205	N	100
TP-348-XL	9249-50130	174	883.92	0.230	N	100
TP-352-XL	9249-50131	176	894.08	0.275	N	100

TWIN POWER

L - 3/8" - 0.375" - 9.525 MM PITCH					
1/2" - 12.5 MM WIDE					
Item description	Product Number	Teeth	Pitch Length (mm)	Weight (kg)	Stock
TP-202-L-050	9246-50224	54	514.35	0.031	N
TP-210-L-050	9246-21021	56	533.40	0.026	N
TP-225-L-050	9246-21022	60	571.50	0.028	N
TP-240-L-050	9246-21024	64	609.60	0.030	Y
TP-255-L-050	9246-21025	68	647.70	0.032	N
TP-270-L-050	9246-21027	72	685.80	0.034	N
TP-285-L-050	9246-21028	76	723.90	0.036	N
TP-300-L-050	9246-21030	80	762.00	0.038	Y
TP-322-L-050	9246-21032	86	819.15	0.040	Y
TP-345-L-050	9246-21034	92	876.30	0.043	Y
TP-367-L-050	9246-21036	98	933.45	0.046	Y
TP-390-L-050	9246-21039	104	990.60	0.042	Y
TP-420-L-050	9246-21042	112	1066.80	0.045	Y
TP-450-L-050	9246-21045	120	1143.00	0.058	Y
TP-480-L-050	9246-21048	128	1219.20	0.052	Y
TP-510-L-050	9246-21051	136	1295.40	0.060	Y
TP-540-L-050	9246-21054	144	1371.60	0.070	N
TP-600-L-050	9246-21060	160	1524.00	0.104	Y
TP-630-L-050	9246-50225	168	1600.20	0.091	N
TP-660-L-050	9246-21066	176	1676.40	0.077	Y

L - 3/8" - 0.375" - 9.525 MM PITCH					
3/4" - 19.1 MM WIDE					
Item description	Product Number	Teeth	Pitch Length (mm)	Weight (kg)	Stock
TP-202-L-075	9246-50000	54	514.35	0.045	N
TP-210-L-075	9246-22021	56	533.40	0.047	N
TP-225-L-075	9246-22022	60	571.50	0.050	N
TP-240-L-075	9246-22024	64	609.60	0.129	Y
TP-255-L-075	9246-22025	68	647.70	0.056	N
TP-270-L-075	9246-22027	72	685.80	0.059	N
TP-285-L-075	9246-22028	76	723.90	0.063	N
TP-300-L-075	9246-22030	80	762.00	0.066	Y
TP-322-L-075	9246-22032	86	819.15	0.071	Y
TP-345-L-075	9246-22034	92	876.30	0.076	Y
TP-367-L-075	9246-22036	98	933.45	0.081	Y
TP-390-L-075	9246-22039	104	990.60	0.063	Y
TP-420-L-075	9246-22042	112	1066.80	0.082	Y
TP-450-L-075	9246-22045	120	1143.00	0.073	Y
TP-480-L-075	9246-22048	128	1219.20	0.078	Y
TP-510-L-075	9246-22051	136	1295.40	0.100	Y
TP-540-L-075	9246-22054	144	1371.60	0.106	N
TP-600-L-075	9246-22060	160	1524.00	0.118	Y
TP-630-L-075	9246-50236	168	1600.20	0.138	N
TP-660-L-075	9246-22066	176	1676.40	0.129	Y



TWIN POWER POWERGRIP XL, L, H TIMING BELTS AND SLABS

L - 3/8" - 0.375" - 9.525 MM PITCH					
1" - 25.4 MM WIDE					
Item description	Product Number	Teeth	Pitch Length (mm)	Weight (kg)	Stock
TP-202-L-100	9246-50199	54	514.35	0.061	N
TP-210-L-100	9246-23021	56	533.40	0.062	N
TP-225-L-100	9246-23022	60	571.50	0.067	N
TP-240-L-100	9246-23024	64	609.60	0.071	Y
TP-255-L-100	9246-23025	68	647.70	0.075	N
TP-270-L-100	9246-23027	72	685.80	0.080	N
TP-285-L-100	9246-23028	76	723.90	0.084	N
TP-300-L-100	9246-23030	80	762.00	0.088	Y
TP-322-L-100	9246-23032	86	819.15	0.095	Y
TP-345-L-100	9246-23034	92	876.30	0.101	Y
TP-367-L-100	9246-23036	98	933.45	0.108	Y
TP-390-L-100	9246-23039	104	990.60	0.101	Y
TP-420-L-100	9246-23042	112	1066.80	0.109	Y
TP-450-L-100	9246-23045	120	1143.00	0.098	Y
TP-480-L-100	9246-23048	128	1219.20	0.125	Y
TP-510-L-100	9246-23051	136	1295.40	0.133	Y
TP-540-L-100	9246-23054	144	1371.60	0.140	N
TP-600-L-100	9246-23060	160	1524.00	0.141	Y
TP-630-L-100	9246-50227	168	1600.20	0.183	N
TP-660-L-100	9246-23066	176	1676.40	0.155	Y

L - 3/8" - 0.375" - 9.525 MM PITCH						
SLABS						
Item description	Product Number	Teeth	Pitch Length (mm)	Weight (kg)	Stock	Width (mm)
TP-202-L	9249-50123	54	514.35	0.231	N	100
TP-210-L	9249-50060	56	533.40	0.215	N	100
TP-225-L	9249-50093	60	571.50	0.230	N	100
TP-240-L	9249-50030	64	609.60	0.246	Y	100
TP-255-L	9249-50080	68	647.70	0.261	N	100
TP-270-L	9249-50089	72	685.80	0.276	N	100
TP-285-L	9249-50061	76	723.90	0.292	N	100
TP-300-L	9249-50082	80	762.00	0.307	Y	100
TP-322-L	9249-50031	86	819.15	0.330	Y	100
TP-345-L	9249-50032	92	876.30	0.353	Y	100
TP-367-L	9249-50124	98	933.45	0.421	Y	100
TP-390-L	9249-50085	104	990.60	0.479	Y	130
TP-420-L	9249-50033	112	1066.80	0.516	Y	130
TP-450-L	9249-50034	120	1143.00	0.553	Y	130
TP-480-L	9249-50035	128	1219.20	0.590	Y	130
TP-510-L	9249-50036	136	1295.40	0.679	Y	130
TP-540-L	9249-50083	144	1371.60	0.719	N	130
TP-600-L	9249-50037	160	1524.00	0.798	Y	130
TP-630-L	9249-50125	168	1600.20	0.937	N	130
TP-660-L	9249-50084	176	1676.40	0.878	Y	130

TWIN POWER



TWIN POWER POWERGRIP XL, L, H TIMING BELTS AND SLABS

H - 1/2" - 0.500" - 12.7 MM PITCH					
3/4" - 19.1 MM WIDE					
Item description	Product Number	Teeth	Pitch Length (mm)	Weight (kg)	Stock
TP-240-H-075	9246-50249	48	609.60	0.020	N
TP-270-H-075	9246-50218	54	685.80	0.073	Y
TP-300-H-075	9246-03102	60	762.00	0.210	Y
TP-330-H-075	9246-50223	66	838.20	0.111	Y
TP-360-H-075	9246-31036	72	914.40	0.080	Y
TP-390-H-075	9246-31039	78	990.60	0.099	N
TP-420-H-075	9246-31042	84	1066.80	0.082	Y
TP-450-H-075	9246-31045	90	1143.00	0.114	N
TP-480-H-075	9246-31048	96	1219.20	0.006	Y
TP-510-H-075	9246-31051	102	1295.40	0.155	Y
TP-540-H-075	9246-31054	108	1371.60	0.164	Y
TP-570-H-075	9246-31057	114	1447.80	0.173	Y
TP-600-H-075	9246-31060	120	1524.00	0.182	Y
TP-630-H-075	9246-31063	126	1600.20	0.191	Y
TP-660-H-075	9246-31066	132	1676.40	0.200	Y
TP-700-H-075	9246-31070	140	1778.00	0.212	Y
TP-750-H-075	9246-31075	150	1905.00	0.227	Y
TP-800-H-075	9246-31080	160	2032.00	0.242	Y
TP-850-H-075	9246-31085	170	2159.00	0.233	Y
TP-900-H-075	9246-31090	180	2286.00	0.246	Y
TP-1000-H-075	9246-31100	200	2540.00	0.273	Y
TP-1100-H-075	9246-31110	220	2794.00	0.301	Y
TP-1250-H-075	9246-31125	250	3175.00	0.315	N
TP-1400-H-075	9246-50204	280	3556.00	0.353	N
TP-1700-H-075	9246-50205	340	4318.00	0.378	Y

H - 1/2" - 0.500" - 12.7 MM PITCH					
1" - 25.4 MM WIDE					
Item description	Product Number	Teeth	Pitch Length (mm)	Weight (kg)	Stock
TP-240-H-100	9246-50250	48	609.60	0.081	N
TP-270-H-100	9246-50219	54	685.80	0.270	Y
TP-300-H-100	9246-03202	60	762.00	0.270	Y
TP-330-H-100	9246-03224	66	838.20	0.330	Y
TP-360-H-100	9246-32036	72	914.40	0.121	Y
TP-390-H-100	9246-32039	78	990.60	0.132	N
TP-420-H-100	9246-32042	84	1066.80	0.142	Y
TP-450-H-100	9246-32045	90	1143.00	0.152	N
TP-480-H-100	9246-32048	96	1219.20	0.008	Y
TP-510-H-100	9246-32051	102	1295.40	0.171	Y
TP-540-H-100	9246-32054	108	1371.60	0.197	Y
TP-570-H-100	9246-32057	114	1447.80	0.208	Y
TP-600-H-100	9246-32060	120	1524.00	0.201	Y
TP-630-H-100	9246-32063	126	1600.20	0.229	Y
TP-660-H-100	9246-32066	132	1676.40	0.240	Y
TP-700-H-100	9246-32070	140	1778.00	0.254	Y
TP-750-H-100	9246-32075	150	1905.00	0.273	Y
TP-800-H-100	9246-32080	160	2032.00	0.291	Y
TP-850-H-100	9246-32085	170	2159.00	0.291	Y
TP-900-H-100	9246-32090	180	2286.00	0.308	Y
TP-1000-H-100	9246-32100	200	2540.00	0.342	Y
TP-1100-H-100	9246-32110	220	2794.00	0.376	Y
TP-1250-H-100	9246-32125	250	3175.00	0.427	N
TP-1400-H-100	9246-32140	280	3556.00	0.478	N
TP-1700-H-100	9246-50206	340	4318.00	0.505	Y

TWIN POWER



TWIN POWER POWERGRIP XL, L, H TIMING BELTS AND SLABS

H - 1/2" - 0.500" - 12.7 MM PITCH					
1,5" - 38.1 MM WIDE					
Item description	Product Number	Teeth	Pitch Length (mm)	Weight (kg)	Stock
TP-270-H-150	9246-50220	54	685.80	0.146	Y
TP-300-H-150	9246-50109	60	762.00	0.151	Y
TP-330-H-150	9246-03324	66	838.20	2.170	Y
TP-360-H-150	9246-33036	72	914.40	0.246	Y
TP-390-H-150	9246-33039	78	990.60	0.198	N
TP-420-H-150	9246-33042	84	1066.80	0.213	Y
TP-450-H-150	9246-33045	90	1143.00	0.228	N
TP-480-H-150	9246-33048	96	1219.20	0.013	Y
TP-510-H-150	9246-33051	102	1295.40	0.310	Y
TP-540-H-150	9246-33054	108	1371.60	0.328	Y
TP-570-H-150	9246-33057	114	1447.80	0.346	Y
TP-600-H-150	9246-33060	120	1524.00	0.364	Y
TP-630-H-150	9246-33063	126	1600.20	0.382	Y
TP-660-H-150	9246-33066	132	1676.40	0.400	Y
TP-700-H-150	9246-33070	140	1778.00	0.424	Y
TP-750-H-150	9246-33075	150	1905.00	0.454	Y
TP-800-H-150	9246-33080	160	2032.00	0.485	Y
TP-850-H-150	9246-33085	170	2159.00	0.582	Y
TP-900-H-150	9246-33090	180	2286.00	0.616	Y
TP-1000-H-150	9246-33100	200	2540.00	0.684	Y
TP-1100-H-150	9246-33110	220	2794.00	0.752	Y
TP-1250-H-150	9246-33125	250	3175.00	0.629	N
TP-1400-H-150	9246-33140	280	3556.00	0.705	N
TP-1700-H-150	9246-50207	340	4318.00	0.757	Y

H - 1/2" - 0.500" - 12.7 MM PITCH					
2" - 50.8 MM WIDE					
Item description	Product Number	Teeth	Pitch Length (mm)	Weight (kg)	Stock
TP-270-H-200	9246-50221	54	685.80	0.195	Y
TP-300-H-200	9246-03402	60	762.00	0.540	N
TP-330-H-200	9246-03424	66	838.20	0.550	Y
TP-360-H-200	9246-34036	72	914.40	0.246	Y
TP-390-H-200	9246-34039	78	990.60	0.264	N
TP-420-H-200	9246-34042	84	1066.80	0.219	Y
TP-450-H-200	9246-34045	90	1143.00	0.304	N
TP-480-H-200	9246-34048	96	1219.20	0.017	Y
TP-510-H-200	9246-34051	102	1295.40	0.342	Y
TP-540-H-200	9246-34054	108	1371.60	0.493	Y
TP-570-H-200	9246-34057	114	1447.80	0.520	Y
TP-600-H-200	9246-34060	120	1524.00	0.547	Y
TP-630-H-200	9246-34063	126	1600.20	0.574	Y
TP-660-H-200	9246-34066	132	1676.40	0.443	Y
TP-700-H-200	9246-34070	140	1778.00	0.637	Y
TP-750-H-200	9246-34075	150	1905.00	0.682	Y
TP-800-H-200	9246-34080	160	2032.00	0.727	Y
TP-850-H-200	9246-34085	170	2159.00	0.582	Y
TP-900-H-200	9246-34090	180	2286.00	0.616	Y
TP-1000-H-200	9246-34100	200	2540.00	0.684	Y
TP-1100-H-200	9246-34110	220	2794.00	0.738	Y
TP-1250-H-200	9246-34125	250	3175.00	0.854	N
TP-1400-H-200	9246-34140	280	3556.00	0.956	N
TP-1700-H-200	9246-50208	340	4318.00	1.009	Y

TWIN POWER



TWIN POWER POWERGRIP XL, L, H TIMING BELTS AND SLABS

H - 1/2" - 0.500" - 12.7 MM PITCH					
SLABS					
Item description	Product Number	Teeth	Pitch Length (mm)	Weight (kg)	Stock
TP-270-H-300	9246-50222	54	685.80	0.293	Y
TP-330-H-300	9246-03524	66	838.20	0.358	Y
TP-360-H-300	9246-35036	72	914.40	0.493	Y
TP-390-H-300	9246-35039	78	990.60	0.397	N
TP-420-H-300	9246-35042	84	1066.80	0.427	Y
TP-450-H-300	9246-35045	90	1143.00	0.457	N
TP-480-H-300	9246-35048	96	1219.20	0.025	Y
TP-510-H-300	9246-35051	102	1295.40	0.699	Y
TP-540-H-300	9246-35054	108	1371.60	0.739	Y
TP-570-H-300	9246-35057	114	1447.80	0.780	Y
TP-600-H-300	9246-35060	120	1524.00	0.820	Y
TP-630-H-300	9246-35063	126	1600.20	0.861	Y
TP-660-H-300	9246-35066	132	1676.40	0.901	Y
TP-700-H-300	9246-35070	140	1778.00	0.956	Y
TP-750-H-300	9246-35075	150	1905.00	1.023	Y
TP-800-H-300	9246-35080	160	2032.00	1.091	Y
TP-850-H-300	9246-35085	170	2159.00	1.165	Y
TP-900-H-300	9246-35090	180	2286.00	1.233	Y
TP-1000-H-300	9246-35100	200	2540.00	1.369	Y
TP-1100-H-300	9246-35110	220	2794.00	1.505	Y
TP-1250-H-300	9246-35125	250	3175.00	1.258	N
TP-1400-H-300	9246-35140	280	3556.00	1.409	N
TP-1700-H-300	9246-50209	340	4318.00	1.514	Y

H - 1/2" - 0.500" - 12.7 MM PITCH						
SLABS						
Item description	Product Number	Teeth	Pitch Length (mm)	Weight (kg)	Stock	Width (mm)
TP-240-H	9249-50133	48	609.60	0.427	N	100
TP-270-H	9249-50091	54	685.80	0.357	Y	100
TP-300-H	9249-50062	60	762.00	0.396	Y	100
TP-330-H	9249-50063	66	838.20	0.436	Y	100
TP-360-H	9249-50076	72	914.40	0.475	Y	100
TP-390-H	9249-50096	78	990.60	1.746	N	330
TP-420-H	9249-50097	84	1066.80	1.831	Y	330
TP-450-H	9249-50098	90	1143.00	1.961	N	330
TP-480-H	9249-50099	96	1219.20	2.092	Y	330
TP-510-H	9249-50100	102	1295.40	2.223	Y	330
TP-540-H	9249-50102	108	1371.60	2.354	Y	330
TP-570-H	9249-50103	114	1447.80	2.484	Y	330
TP-600-H	9249-50104	120	1524.00	2.615	Y	330
TP-630-H	9249-50105	126	1600.20	2.746	Y	330
TP-660-H	9249-50106	132	1676.40	2.877	Y	330
TP-700-H	9249-50066	140	1778.00	3.051	Y	330
TP-750-H	9249-50028	150	1905.00	3.269	Y	330
TP-800-H	9249-50029	160	2032.00	3.487	Y	330
TP-850-H	9249-50003	170	2159.00	3.705	Y	330
TP-900-H	9249-50110	180	2286.00	3.923	Y	330
TP-1000-H	9249-50070	200	2540.00	4.359	Y	330
TP-1100-H	9249-50008	220	2794.00	4.759	Y	330
TP-1250-H	9249-50081	250	3175.00	5.448	N	330
TP-1400-H	9249-50092	280	3556.00	6.102	N	330
TP-1700-H	9249-50107	340	4318.00	7.410	Y	330

TWIN POWER



LONG LENGTH POLY CHAIN GT CARBON AND LONG LENGTH POWERGRIP BELTING

Recommended Sprockets

- Poly Chain belt with Poly Chain GT Sprockets
- PowerGrip GT belts with PowerGrip GT sprockets
- PowerGrip HTD belts with PowerGrip HTD sprockets

NOTES: Long Length belts are supplied in fixed continuous roll lengths. Minimum standard roll lengths for Long Length belts are 30 meters (*). Other roll lengths are available on demand in increments of 30 meter. Minimum order quantities may vary for non-standard roll lengths or non-standard widths. Check with Customer Service.
 (*) Except LL MXL and LL GT 2MR

ITEM DESCRIPTION BUILD UP: LL-pitch-width-roll length-cord type

SECTION	ITEM DESCRIPTION	WIDTH (MM)	PRODUCT NUMBER	CORD TYPE	ROLL LENGTH (M)	WEIGHT (KG/METER)	STOCK	VERSION
LL-PCC	LL-8MGT-12-30M	12	9302-01900	CARBON	30	0.056	Y	Spiral cut
	LL-8MGT-21-30M	21	9302-01910	CARBON	30	0.099	Y	Spiral cut
	LL-8MGT-36-30M	36	9302-01920	CARBON	30	0.169	Y	Spiral cut
	LL-14MGT-20-30M	20	9302-01930	CARBON	30	0.158	Y	Spiral cut
	LL-14MGT-37-30M	37	9302-01940	CARBON	30	0.292	Y	Spiral cut
LL-GT	LL-2MR-3-350M-GL	3	9396-00097	GLASS	350	0.005	N	Spiral cut
	LL-2MR-6-182M-GL	6	9396-00009	GLASS	182	0.011	N	Spiral cut
	LL-2MR-9-118M-GL	9	9396-00052	GLASS	118.87	0.001	N	Spiral cut
	LL-3MR-6-30M-GL	6	9396-40405	GLASS	30	0.016	Y	Straight cut
	LL-3MR-9-30M-GL	9	9396-40407	GLASS	30	0.024	Y	Straight cut
	LL-3MR-15-30M-GL	15	9396-40409	GLASS	30	0.041	Y	Straight cut
	LL-5MR-6-30M-GL	6	9396-40447	GLASS	30	0.024	N	Straight cut
	LL-5MR-6-30M-ST	6	9396-10041	STEEL	30	0.028	N	Straight cut
	LL-5MR-10-30M-GL	10	9396-40413	GLASS	30	0.041	Y	Straight cut
	LL-5MR-10-30M-ST	10	9396-40412	STEEL	30	0.047	Y	Straight cut
	LL-5MR-15-30M-GL	15	9396-40415	GLASS	30	0.061	Y	Straight cut
	LL-5MR-15-30M-ST	15	9396-10043	STEEL	30	0.071	Y	Straight cut
	LL-5MR-25-30M-GL	25	9396-40418	GLASS	30	0.103	Y	Straight cut
	LL-5MR-25-30M-ST	25	9396-40417	STEEL	30	0.118	Y	Straight cut
	LL-8MR-10-30M-GL	10	9396-10047	GLASS	30	0.060	N	Straight cut
	LL-8MR-10-30M-ST	10	9396-40420	STEEL	30	0.076	Y	Straight cut
	LL-8MR-15-30M-GL	15	9396-40423	GLASS	30	0.090	Y	Straight cut
	LL-8MR-15-30M-ST	15	9396-10048	STEEL	30	0.114	Y	Straight cut
	LL-8MR-20-30M-GL	20	9396-40425	GLASS	30	0.120	Y	Straight cut
	LL-8MR-20-30M-ST	20	9396-10049	STEEL	30	0.152	Y	Straight cut
	LL-8MR-30-30M-GL	30	9396-40430	GLASS	30	0.180	Y	Straight cut
	LL-8MR-30-30M-ST	30	9396-10050	STEEL	30	0.228	Y	Straight cut
	LL-8MR-50-30M-GL	50	9396-40434	GLASS	30	0.300	Y	Straight cut
	LL-8MR-50-30M-ST	50	9396-40433	STEEL	30	0.380	Y	Straight cut

LONG LENGTH



LONG LENGTH POLY CHAIN GT CARBON AND LONG LENGTH POWERGRIP BELTING

SECTION	ITEM DESCRIPTION	WIDTH (MM)	PRODUCT NUMBER	CORD TYPE	ROLL LENGTH (M)	WEIGHT (KG/METER)	STOCK	VERSION
LL-HTD	LL-3M-6-30M-GL	6	9308-10092	GLASS	30	0.016	Y	Straight cut
	LL-3M-9-30M-GL	9	9308-10052	GLASS	30	0.024	Y	Straight cut
	LL-3M-15-30M-GL	15	9308-10095	GLASS	30	0.041	Y	Straight cut
	LL-5M-6-30M-GL	6	9308-10038	GLASS	30	0.024	Y	Straight cut
	LL-5M-6-30M-ST	6	9308-10041	STEEL	30	0.031	N	Straight cut
	LL-5M-10-30M-GL	10	9308-40147	GLASS	30	0.041	Y	Straight cut
	LL-5M-10-30M-ST	10	9308-40146	STEEL	30	0.050	Y	Straight cut
	LL-5M-15-30M-GL	15	9308-10040	GLASS	30	0.061	Y	Straight cut
	LL-5M-15-30M-ST	15	9308-10043	STEEL	30	0.075	Y	Straight cut
	LL-5M-25-30M-GL	25	9308-10060	GLASS	30	0.103	Y	Straight cut
	LL-5M-25-30M-ST	25	9308-10082	STEEL	30	0.118	Y	Straight cut
	LL-8M-10-30M-GL	10	9308-10044	GLASS	30	0.067	Y	Straight cut
	LL-8M-10-30M-ST	10	9308-10047	STEEL	30	0.073	Y	Straight cut
	LL-8M-15-30M-GL	15	9308-10045	GLASS	30	0.100	Y	Straight cut
	LL-8M-15-30M-ST	15	9308-10048	STEEL	30	0.109	Y	Straight cut
	LL-8M-20-30M-GL	20	9308-10046	GLASS	30	0.135	Y	Straight cut
	LL-8M-20-30M-ST	20	9308-10049	STEEL	30	0.146	Y	Straight cut
	LL-8M-30-30M-GL	30	9308-10019	GLASS	30	0.202	Y	Straight cut
	LL-8M-30-30M-ST	30	9308-10050	STEEL	30	0.222	Y	Straight cut
	LL-8M-50-30M-GL	50	9308-10063	GLASS	30	0.337	Y	Straight cut
	LL-8M-50-30M-ST	50	9308-10083	STEEL	30	0.370	Y	Straight cut
	LL-8M-85-30M-GL	85	9308-10064	GLASS	30	0.544	Y	Straight cut
	LL-8M-85-30M-ST	85	9308-10065	STEEL	30	0.578	Y	Straight cut
	LL-14M-25-30M-GL	25	9308-10008	GLASS	30	0.264	N	Straight cut
	LL-14M-25-30M-ST	25	9308-40470	STEEL	30	0.357	N	Straight cut
	LL-14M-40-30M-GL	40	9308-10009	GLASS	30	0.388	Y	Straight cut
	LL-14M-40-30M-ST	40	9308-10016	STEEL	30	0.605	Y	Straight cut
	LL-14M-55-30M-GL	55	9308-10020	GLASS	30	0.534	Y	Straight cut
	LL-14M-55-30M-ST	55	9308-10051	STEEL	30	0.855	Y	Straight cut
	LL-14M-85-30M-GL	85	9308-10057	GLASS	30	0.825	Y	Straight cut
	LL-14M-85-30M-ST	85	9308-10084	STEEL	30	1.330	Y	Straight cut
	LL-14M-115-30M-GL	115	9308-10098	GLASS	30	1.185	Y	Straight cut
	LL-14M-115-30M-ST	115	9308-10099	STEEL	30	1.756	Y	Straight cut
	LL-MXL-019-201M-GL	4.8	9314-02070	GLASS	201.168	0.008	N	Spiral cut
	LL-MXL-025-147M-GL	6.4	9314-02020	GLASS	147.8	0.011	N	Spiral cut
	LL-MXL-050-73M-GL	12.7	9314-02038	GLASS	73.15	0.001	N	Spiral cut
	LL-XL-025-30M-GL	6.4	9314-10025	GLASS	30	0.018	Y	Straight cut
	LL-XL-031-30M-GL	7.9	9314-10085	GLASS	30	0.016	N	Straight cut
	LL-XL-037-30M-GL	9.5	9314-10026	GLASS	30	0.019	Y	Straight cut
	LL-XL-050-30M-GL	12.7	9314-10027	GLASS	30	0.036	N	Straight cut
LL-L-037-30M-GL	9.5	9314-10031	GLASS	30	0.029	N	Straight cut	
LL-L-050-30M-GL	12.7	9314-10032	GLASS	30	0.039	Y	Straight cut	
LL-L-075-30M-GL	19.1	9314-10033	GLASS	30	0.059	Y	Straight cut	
LL-L-100-30M-GL	25.4	9314-10087	GLASS	30	0.079	Y	Straight cut	
LL-H-050-30M-GL	12.7	9314-10003	GLASS	30	0.051	N	Straight cut	
LL-H-050-30M-ST	12.7	9314-10010	STEEL	30	0.051	N	Straight cut	
LL-H-075-30M-GL	19.1	9314-10004	GLASS	30	0.076	Y	Straight cut	
LL-H-075-30M-ST	19.1	9314-10011	STEEL	30	0.121	N	Straight cut	
LL-H-100-30M-GL	25.4	9314-10023	GLASS	30	0.102	Y	Straight cut	
LL-H-100-30M-ST	25.4	9314-10037	STEEL	30	0.157	N	Straight cut	
LL-H-150-30M-GL	38.1	9314-10081	GLASS	30	0.154	Y	Straight cut	
LL-H-150-30M-ST	38.1	9314-10089	STEEL	30	0.269	N	Straight cut	
LL-H-200-30M-GL	50.8	9314-40083	GLASS	30	0.204	N	Straight cut	
LL-H-200-30M-ST	50.8	9314-40082	STEEL	30	0.283	N	Straight cut	
LL-H-300-30M-GL	76.2	9314-40085	GLASS	30	0.304	N	Straight cut	

LONG LENGTH



SPROCKETS POLY CHAIN GT 8MGT - 14MGT

Sprocket TYPES

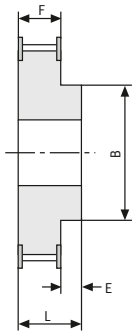

Type 1 F

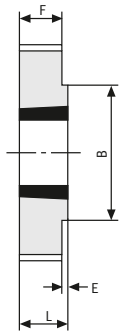

Type 2

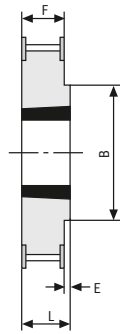

Type 2 F

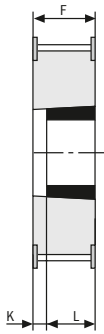

Type 3 F

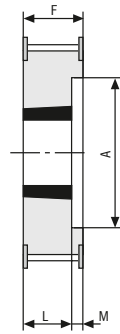

Type 5 F

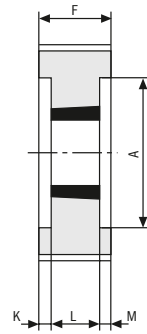

Type 6

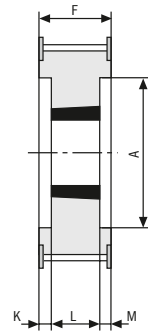

Type 6F

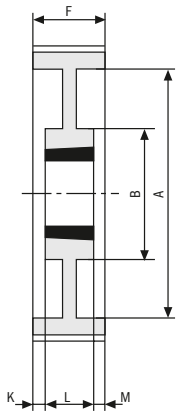

Type 7

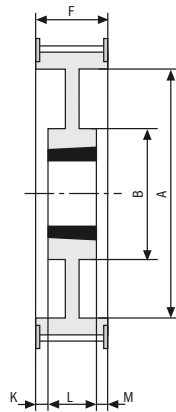

Type 7 F

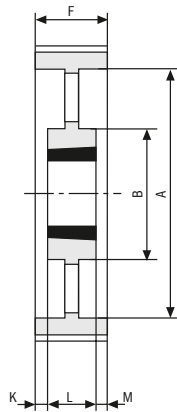

Type 8

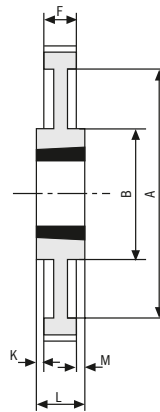

Type 9

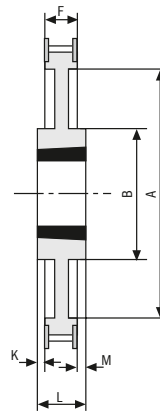

Type 9 F

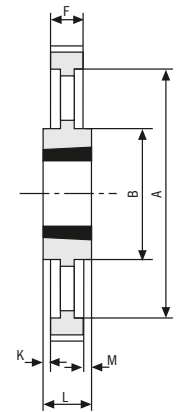

Type 10

POLY CHAIN
SPROCKETS

SPROCKET INFORMATION

Sprocket SPECIFICATIONS

NOTES: Sprockets of cast iron or steel material are supplied. Sprockets of either material provide required durability and service life. Gates reserves the right to supply sprockets of either material against orders for standard sprockets.

SPECIFICATION: cast iron 220 N/mm² / steel 220 M07.

Sprocket Designation	No. of Teeth	Sprocket Type	Bush No.	Max. Bore		Diameter mm			A	B	E	F	K	L	M	Weight kg	Moment of inertia 10 ⁻⁴ kgm ²
				Metric	Inch	Pitch	Outside	Flange									
8M-22S-12	22	1F	PB	28*	1 5/8	56.02	54.42	60	-	43	10	20	-	30	-	0.43	1.68
8M-25S-12	25	2F	1108	28	1 5/8	63.66	62.06	70	-	49	2	20	-	22	-	0.25	1.26
8M-28S-12	28	2F	1108	28	1 5/8	71.30	69.70	75	-	56	2	20	-	22	-	0.37	2.35
8M-30S-12	30	2F	1210	32	1 5/8	76.39	74.79	82.5	-	60	5	20	-	25	-	0.41	2.99
8M-32S-12	32	2F	1610	42	1 5/8	81.49	79.89	87	-	66	5	20	-	25	-	0.37	3.07
8M-34S-12	34	2F	1610	42	1 1/4	86.58	84.98	91	-	69	5	20	-	25	-	0.45	4.21
8M-36S-12	36	2F	1610	42	1 1/8	91.67	90.07	97	-	76	5	20	-	25	-	0.59	6.19
8M-38S-12	38	2F	1610	42	1 1/8	96.77	95.17	102	-	78	5	20	-	25	-	0.70	8.19
8M-40S-12	40	2F	1610	42	1 1/8	101.86	100.26	106	-	85	5	20	-	25	-	0.82	10.63
8M-45S-12	45	2F	2012	50	2	114.59	112.99	120	-	92	12	20	-	32	-	1.10	18.05
8M-48S-12	48	2F	2012	50	2	112.23	120.63	128	-	103	12	20	-	32	-	1.42	26.51
8M-50S-12	50	2F	2012	50	2	127.32	125.72	135	-	104	12	20	-	32	-	1.60	32.42
8M-56S-12	56	2F	2012	50	2	142.60	141.00	150	-	104	12	20	-	32	-	2.10	53.37
8M-60S-12	60	2F	2012	50	2	152.79	151.19	158	-	111	12	20	-	32	-	2.40	70.03
8M-64S-12	64	2F	2012	50	2	162.97	161.37	168	-	111	12	20	-	32	-	2.70	89.64
8M-75S-12	75	2	2012	50	2	190.99	189.39	-	-	111	12	20	-	32	-	3.70	168.70
8M-80S-12	80	2	2012	50	2	203.72	202.12	-	-	111	12	20	-	32	-	4.40	228.26
8M-90S-12	90	2	2012	50	2	229.18	227.58	-	-	111	12	20	-	32	-	5.50	361.10
8M-22S-21	22	1F	PB	28*	1 1/8	56.02	54.42	60	-	43	12	30	-	42	-	0.56	2.19
8M-25S-21	25	3F	1108	28	1 1/8	63.66	62.06	70	-	-	-	30	8	22	-	0.36	1.82
8M-28S-21	28	3F	1210	32	1 1/4	71.30	69.70	75	-	-	-	30	5	25	-	0.41	2.60
8M-30S-21	30	3F	1210	32	1 1/4	76.39	74.79	82.5	-	-	-	30	5	25	-	0.56	4.08
8M-32S-21	32	3F	1610	42	1 5/8	81.49	79.89	87	-	-	-	30	5	25	-	0.52	4.31
8M-34S-21	34	3F	1610	42	1 5/8	86.58	84.98	91	-	-	-	30	5	25	-	0.61	5.72
8M-36S-21	36	3F	1610	42	1 5/8	91.67	90.07	97	-	-	-	30	5	25	-	0.70	7.13
8M-38S-21	38	3F	1610	42	1 5/8	96.77	95.17	102	-	-	-	30	5	25	-	0.92	10.72
8M-40S-21	40	3F	1610	42	1 5/8	101.86	100.26	106	-	-	-	30	5	25	-	1.06	13.75
8M-45S-21	45	2F	2012	50	2	114.59	112.99	120	-	92	2	30	-	32	-	1.30	21.33
8M-48S-21	48	2F	2012	50	2	122.23	120.63	128	-	103	2	30	-	32	-	1.60	29.88
8M-50S-21	50	2F	2012	50	2	127.32	125.72	135	-	104	2	30	-	32	-	1.83	37.08
8M-56S-21	56	2F	2012	50	2	142.60	141.00	150	-	111	2	30	-	32	-	2.40	61.00
8M-60S-21	60	2F	2517	60	2 1/2	152.79	151.19	158	-	124	15	30	-	45	-	3.20	93.37
8M-64S-21	64	2F	2517	60	2 1/2	162.97	161.37	168	-	124	15	30	-	45	-	3.80	126.15
8M-75S-21	75	2	2517	60	2 1/2	190.99	189.39	-	-	124	15	30	-	45	-	5.20	237.10
8M-80S-21	80	2	2517	60	2 1/2	203.72	202.12	-	-	124	15	30	-	45	-	6.00	311.41
8M-90S-21	90	9	2517	60	2 1/2	229.18	227.58	-	198	124	-	30	7.5	45	7.5	5.40	354.53
8M-112S-21	112	9	2517	60	2 1/2	285.21	283.61	-	253	124	-	30	7.5	45	7.5	7.40	752.44
8M-140S-21	140	10	3020	75	3	356.51	354.91	-	324	150	-	30	10.5	51	10.5	9.00	1429.86

* Max. bore to be fitted with shallow keys. PB = Plain Bored Bush. For peripheral speeds greater than 40 m/sec consult Gates.



SPROCKET INFORMATION

Sprocket SPECIFICATIONS

NOTES: Sprockets of cast iron or steel material are supplied. Sprockets of either material provide required durability and service life. Gates reserves the right to supply sprockets of either material against orders for standard sprockets.

SPECIFICATION: cast iron 220 N/mm2 / steel 220 M07.

Sprocket Designation	No. of Teeth	Sprocket Type	Bush No.	Max. Bore		Diameter mm			A	B	E	F	K	L	M	Weight kg	Moment of inertia 10 ⁻⁴ kgm ²
				Metric	Inch	Pitch	Outside	Flange									
8M-25S-36	25	1F	PB	32	2	63.66	62.06	70	-	49	10	45	-	55	-	1.04	5.26
8M-28S-36	28	3F	1108	32	1 1/4	71.30	69.70	75	-	-	-	45	-	-	-	0.64	4.06
8M-30S-36	30	3F	1108	42	1 1/4	76.39	74.79	82.5	-	-	-	45	-	-	-	0.59	4.30
8M-32S-36	32	3F	1210	42	1 5/8	81.49	79.89	87	-	-	-	45	-	-	-	0.79	6.55
8M-34S-36	34	3F	1610	42	1 5/8	86.58	84.98	91	-	-	-	45	-	-	-	0.93	8.71
8M-36S-36	36	3F	1610	42	1 5/8	91.67	90.07	97	-	-	-	45	-	-	-	1.15	12.07
8M-38S-36	38	3F	1610	42	1 5/8	96.77	95.17	102	-	-	-	45	-	-	-	1.39	16.27
8M-40S-36	40	3F	1610	50	1 5/8	101.86	100.26	106	-	-	-	45	-	-	-	1.34	17.37
8M-45S-36	45	3F	1610	50	1 5/8	114.59	112.99	120	-	-	-	45	-	-	-	1.87	30.69
8M-48S-36	48	3F	2012	50	2 1/2	122.23	120.63	128	-	-	-	45	-	-	-	2.20	41.09
8M-50S-36	50	3F	2012	50	2 1/2	127.32	125.72	135	-	-	-	45	-	-	-	2.70	54.71
8M-56S-36	56	3F	2012	60	2 1/2	142.60	141.00	150	-	-	-	45	-	-	-	3.00	76.26
8M-60S-36	60	3F	2012	60	2 1/2	152.79	151.19	158	-	-	-	45	-	-	-	3.80	110.88
8M-64S-36	64	3F	2012	60	2 1/2	161.97	161.37	168	-	-	-	45	-	-	-	4.50	149.40
8M-75S-36	75	2	2012	75	2 1/2	190.99	189.39	-	-	150	6	45	-	51	-	6.20	282.70
8M-80S-36	80	2	2012	75	2 1/2	203.72	202.12	-	-	150	6	45	-	51	-	7.40	383.89
8M-90S-36	90	9	2012	75	2 1/2	229.18	227.58	-	197	150	-	45	3	51	3	7.20	472.71
8M-112S-36	112	9	2012	75	2 1/2	285.21	283.61	-	253	150	-	45	3	51	3	10.40	1057.50
8M-140S-36	140	10	PB	75	2 1/2	356.51	354.91	-	324	150	-	45	3	51	3	12.70	2017.70
8M-168S-36	168	10	1108	100	2 1/4	427.81	426.21	-	396	198	-	45	10	65	10	21.50	4918.70
8M-192S-36	192	10	1210	100	2	488.92	487.32	-	457	198	-	45	10	65	10	27.00	8067.69
8M-30S-62	30	1F	1210	42	2	76.39	74.79	82.5	-	63	12	72	-	84	-	2.40	17.50
8M-32S-62	32	1F	1610	50*	2	81.49	79.89	87	-	68	12	72	-	84	-	2.80	23.24
8M-34S-62	34	1F	1610	55*	3	86.58	84.98	91	-	69	12	72	-	84	-	3.00	28.11
8M-36S-62	36	1F	1610	60*	3	91.67	90.07	97	-	76	12	72	-	84	-	3.40	35.71
8M-38S-62	38	1F	1610	60	3	96.77	95.17	102	-	78	12	72	-	84	-	3.80	44.48
8M-40S-62	40	3F	1610	50	3	101.86	100.26	106	-	-	-	72	-	-	-	2.06	26.71
8M-45S-62	45	3F	2012	50	3	114.59	112.99	120	-	-	-	72	-	-	-	3.00	49.24
8M-48S-62	48	3F	2012	60	4	122.23	120.63	128	-	-	-	72	-	-	-	2.90	54.51
8M-50S-62	50	3F	2012	60	4	127.32	125.72	135	-	-	-	72	-	-	-	3.25	65.85
8M-56S-62	56	6F	2012	60	2	142.60	141.00	150	111	-	-	72	13.5	45	13.5	3.90	99.13
8M-60S-62	60	6F	2517	60	2	152.79	151.19	158	121	-	-	72	13.5	45	13.5	4.70	137.15
8M-64S-62	64	6F	2517	60	2	162.97	161.37	168	131	-	-	72	13.5	45	13.5	5.60	185.91
8M-75S-62	75	6	2517	75	3	190.99	189.39	-	159	-	-	72	10.5	51	10.5	7.50	341.87
8M-80S-62	80	6	2517	75	3	203.72	202.12	-	172	-	-	72	10.5	51	10.5	9.20	477.21
8M-90S-62	90	6	2517	75	3	229.18	227.58	-	197	-	-	72	10.5	51	10.5	7.70	505.54
8M-112S-62	112	7	2517	75	3	285.21	283.61	-	253	150	-	72	10.5	51	10.5	12.10	1230.34
8M-140S-62	140	7	3020	100	4	356.51	354.91	-	324	198	-	72	3.5	65	3.5	22.70	3606.44
8M-168S-62	168	8		100	4	427.81	426.21	-	396	198	-	72	3.5	65	3.5	26.80	6131.21
8M-192S-62	192	8		100	4	488.92	487.32	-	457	198	-	72	3.5	65	3.5	34.20	10219.08

* Max. bore to be fitted with shallow keys. PB = Plain Bored Bush. For peripheral speeds greater than 40 m/sec consult Gates.

POLY CHAIN SPROCKETS

SPROCKET INFORMATION

Sprocket SPECIFICATIONS

NOTES: Sprockets of cast iron or steel material are supplied. Sprockets of either material provide required durability and service life. Gates reserves the right to supply sprockets of either material against orders for standard sprockets.

SPECIFICATION: cast iron 220 N/mm² / steel 220 M07.

Sprocket Designation	No. of Teeth	Sprocket Type	Bush No.	Max. Bore		Diameter mm			A	B	E	F	K	L	M	Weight	Moment of inertia 10 ⁻⁴
				Metric	Inch	Pitch	Outside	Flange									
14M-28S-20	28	3F	2012	50	2	124.78	121.98	128	-	-	-	33	-	-	-	1.66	32.30
14M-30S-20	30	3F	2012	50	2	133.69	130.89	138	-	-	-	33	-	-	-	2.20	49.15
14M-32S-20	32	3F	2012	50	2	142.60	139.80	154	-	-	-	33	-	-	-	3.20	81.33
14M-34S-20	34	2F	2517	60	2 1/2	151.52	148.72	160	-	117	12	33	-	45	-	3.00	86.09
14M-36S-20	36	2F	2517	60	2 1/2	160.43	157.63	168	-	117	12	33	-	45	-	3.60	115.82
14M-38S-20	38	2F	2517	60	2 1/2	169.34	166.54	183	-	117	12	33	-	45	-	4.00	143.38
14M-40S-20	40	2F	2517	60	2 1/2	178.25	175.45	188	-	117	12	33	-	45	-	4.70	186.66
14M-44S-20	44	2F	3020	75	3	196.08	193.28	211	-	144	18	33	-	51	-	5.60	269.13
14M-48S-20	48	2F	3020	75	3	213.90	211.11	226	-	144	18	33	-	51	-	6.80	388.90
14M-50S-20	50	2F	3020	75	3	222.82	220.02	240	-	144	18	33	-	51	-	7.70	477.87
14M-56S-20	56	9F	3020	75	3	249.55	246.76	256	207	144	-	33	9	51	9	7.70	599.39
14M-60S-20	60	9	3020	75	3	267.38	264.58	-	224	159	-	33	9	51	9	8.50	759.60
14M-64S-20	64	9	3020	75	3	285.21	282.41	-	242	159	-	33	9	51	9	10.20	1037.15
14M-72S-20	72	9	3020	75	3	320.86	318.06	-	278	159	-	33	9	51	9	11.50	1479.92
14M-80S-20	80	9	3020	75	3	356.51	353.71	-	314	159	-	33	9	51	9	13.50	2144.80
14M-90S-20	90	10	3020	75	3	401.07	398.27	-	360	159	-	33	9	51	9	14.20	2855.21
14M-112S-20	112	10	3020	75	3	499.11	496.31	-	456	159	-	33	9	51	9	18.10	5636.13
14M-140S-20	140	10	3020	75	3	623.89	621.09	-	581	159	-	33	9	51	9	22.90	11149.96
14M-28S-37	28	5F	2012	50	2	124.78	121.98	128	88	-	-	51	-	32	19	2.20	42.81
14M-30S-37	30	6F	2517	60	2 1/2	133.69	130.89	138	98	-	-	51	3	45	3	2.50	55.85
14M-32S-37	32	6F	2517	60	2 1/2	142.60	139.80	154	100	-	-	51	3	45	3	3.00	76.25
14M-34S-37	34	6F	2517	60	2 1/2	151.52	148.72	160	109	-	-	51	3	45	3	3.80	109.05
14M-36S-37	36	5F	2517	60	2 1/2	160.43	157.63	168	117	-	-	51	-	45	6	4.30	138.34
14M-38S-37	38	5F	2517	60	2 1/2	169.34	166.54	183	126	-	-	51	-	45	6	5.10	182.81
14M-40S-37	40	5F	2517	60	2 1/2	178.25	175.45	188	135	-	-	51	-	45	6	6.00	238.30
14M-44S-37	44	3F	3020	75	3	196.08	193.28	211	-	-	-	51	-	-	-	7.00	336.41
14M-48S-37	48	3F	3020	75	3	213.90	211.11	226	-	-	-	51	-	-	-	9.00	514.72
14M-50S-37	50	3F	3020	75	3	222.82	220.02	240	-	-	-	51	-	-	-	10.00	620.61
14M-56S-37	56	7F	3020	75	3	249.55	246.76	256	207	144	-	51	0	51	0	9.20	715.88
14M-60S-37	60	7	3020	75	3	267.38	264.58	-	224	159	-	51	0	51	0	10.20	911.52
14M-64S-37	64	7	3020	75	3	285.21	282.41	-	242	159	-	51	0	51	0	12.20	1240.51
14M-72S-37	72	7	3020	75	3	320.86	318.06	-	278	159	-	51	0	51	0	13.40	1724.43
14M-80S-37	80	7	3020	75	3	356.51	353.71	-	314	159	-	51	0	51	0	16.10	2557.88
14M-90S-37	90	8	3020	75	3	401.07	398.27	-	360	159	-	51	0	51	0	17.20	3458.43
14M-112S-37	112	8	3020	75	3	499.11	496.31	-	456	159	-	51	0	51	0	23.00	7161.94
14M-140S-37	140	10	3525	100	4	623.89	621.09	-	581	206	-	51	7	65	7	41.00	19948.49
14M-168S-37	168	10	3525	100	4	748.66	745.87	-	706	206	-	51	7	65	7	51.50	36081.66
14M-192S-37	192	10	4030	115	4 1/2	855.61	852.82	-	812	215	-	51	12.5	76	12.5	60.00	54905.14

* Max. bore to be fitted with shallow keys. PB = Plain Bored Bush. For peripheral speeds greater than 40 m/sec consult Gates.



SPROCKET INFORMATION

Sprocket SPECIFICATIONS

NOTES: Sprockets of cast iron or steel material are supplied. Sprockets of either material provide required durability and service life. Gates reserves the right to supply sprockets of either material against orders for standard sprockets.

SPECIFICATION: cast iron 220 N/mm2 / steel 220 M07.

Sprocket Designation	No. of Teeth	Sprocket Type	Bush No.	Max. Bore		Diameter mm			A	B	E	F	K	L	M	Weight kg	Moment of inertia 10 ⁴ kgm ²
				Metric	Inch	Pitch	Outside	Flange									
14M-34S-68	34	1F	PB	100	4	151.52	148.72	160	-	132	20	84	-	104	-	10.50	301.33
14M-36S-68	36	1F	PB	100	4 1/4	160.43	157.63	168	-	131	20	84	-	104	-	11.70	376.42
14M-38S-68	38	1F	PB	115*	4 1/4	169.34	166.54	183	-	141	20	84	-	104	-	13.40	481.46
14M-40S-68	40	1F	PB	125*	5	178.25	175.45	188	-	156	20	84	-	104	-	15.40	611.63
14M-44S-68	44	6F	3020	75	3	196.08	193.28	211	153	-	-	84	16.5	51	16.5	9.20	442.14
14M-48S-68	48	5F	3020	75	3	213.90	211.11	226	171	-	-	84	-	51	33	11.30	646.26
14M-50S-68	50	6F	3525	100	4	222.82	220.02	240	180	-	-	84	9.5	65	9.5	15.50	775.76
14M-56S-68	56	6F	3525	100	4	249.55	246.76	256	207	-	-	84	9.5	65	9.5	16.80	1307.78
14M-60S-68	60	6	3525	100	4	267.38	264.58	-	224	-	-	84	9.5	65	9.5	20.40	1823.05
14M-64S-68	64	6	3525	100	4	285.21	282.41	-	242	-	-	84	9.5	65	9.5	23.60	2399.67
14M-72S-68	72	7	3525	100	4	320.86	318.06	-	278	178	-	84	9.5	65	9.5	20.30	2612.89
14M-80S-68	80	7	3525	100	4	356.51	353.71	-	314	178	-	84	9.5	65	9.5	21.30	3384.02
14M-90S-68	90	8	3525	100	4	401.07	398.27	-	360	178	-	84	9.5	65	9.5	24.40	4966.46
14M-112S-68	112	8	3525	100	4	499.11	496.31	-	456	178	-	84	9.5	65	9.5	32.70	10182.40
14M-140S-68	140	8	3525	100	4	623.89	621.09	-	581	206	-	84	9.5	65	9.5	55.00	26760.16
14M-168S-68	168	8	3525	100	4	748.66	745.87	-	706	206	-	84	9.5	65	9.5	71.00	49743.65
14M-192S-68	192	8	4030	115	4 1/2	855.61	852.82	-	812	215	-	84	4	76	4	80.50	73664.39
14M-36S-90	36	1F	PB	110	4 1/4	160.43	157.63	168	-	131	30	106	-	136	-	14.50	466.50
14M-38S-90	38	1F	PB	115	4 1/2	169.34	166.50	183	-	141	30	106	-	136	-	17.50	627.29
14M-40S-90	40	1F	PB	125	5 1/2	178.25	175.45	188	-	156	30	106	-	136	-	19.10	758.59
14M-44S-90	44	1F	PB	140	6 1/2	196.08	193.28	211	-	169	30	106	-	136	-	23.90	1150.95
14M-48S-90	48	6F	3525	100	4	213.90	211.11	226	171	-	-	106	20	66	20	12.70	726.33
14M-50S-90	50	6F	3525	100	4	222.82	220.02	240	180	-	-	106	20	66	20	14.50	899.88
14M-56S-90	56	6F	3525	100	4	249.55	246.76	256	207	-	-	106	20	66	20	19.00	1479.04
14M-60S-90	60	6	3525	100	4	267.38	264.58	-	224	-	-	106	20	66	20	22.50	2010.71
14M-64S-90	64	6	3525	100	4	285.21	282.41	-	242	-	-	106	20	66	20	24.00	2433.77
14M-72S-90	72	7	3525	100	4	320.86	318.06	-	278	178	-	106	20	66	20	22.60	2908.37
14M-80S-90	80	7	4030	115	4 1/2	356.51	353.71	-	314	215	-	106	15	76	15	27.00	4289.60
14M-90S-90	90	7	4030	115	4 1/2	401.07	398.27	-	360	215	-	106	15	76	15	34.10	6856.54
14M-112S-90	112	8	4535	125	5	499.11	496.31	-	456	215	-	106	8	90	8	46.00	14323.87
14M-140S-90	140	8	4535	125	5	623.89	621.09	-	581	215	-	106	8	90	8	61.00	29679.45
14M-168S-90	168	8	5040	130*	5	748.66	745.87	-	706	267	-	106	2	102	2	90.00	63055.33
14M-192S-90	192	8	5040	130*	5	855.61	852.82	-	812	267	-	106	2	102	2	108.50	93796.27

* Max. bore to be fitted with shallow keys. PB = Plain Bored Bush. For peripheral speeds greater than 40 m/sec consult Gates.

POLY CHAIN SPROCKETS

SPROCKET INFORMATION

Sprocket SPECIFICATIONS

NOTES: Sprockets of cast iron or steel material are supplied. Sprockets of either material provide required durability and service life. Gates reserves the right to supply sprockets of either material against orders for standard sprockets.

SPECIFICATION: cast iron 220 N/mm² / steel 220 M07.

Sprocket Designation	No. of Teeth	Sprocket Type	Bush No.	Max. Bore		Diameter mm			A	B	E	F	K	L	M	Weight	Moment of inertia 10 ⁻⁴
				Metric	Inch	Pitch	Outside	Flange									
14M-38S-125	38	1F	PB	115*	4 1/2	169.34	166.54	183	-	141	20	141	-	161	-	20.30	727.65
14M-40S-125	40	1F	PB	125*	5	178.25	175.45	188	-	156	20	141	-	161	-	23.00	913.48
14M-44S-125	44	1F	PB	140*	5 1/2	196.08	193.28	211	-	169	20	141	-	161	-	28.80	1384.10
14M-48S-125	48	1F	PB	160*	6 1/4	213.90	211.11	226	-	185	20	141	-	161	-	34.60	1978.83
14M-50S-125	50	6F	3525	100	4	222.82	220.02	240	180	-	-	141	38	65	38	16.80	1042.62
14M-56S-125	56	6F	3525	100	4	249.55	246.76	256	207	-	-	141	38	65	38	21.60	1681.43
14M-60S-125	60	6	4030	115	4 1/2	267.38	264.58	-	224	-	-	141	32.5	76	32.5	25.60	2287.85
14M-64S-125	64	6	4030	115	4 1/2	285.21	282.41	-	242	-	-	141	32.5	76	32.5	29.70	3024.16
14M-72S-125	72	7	4030	115	4 1/2	320.86	318.06	-	278	215	-	141	32.5	76	32.5	30.00	3860.66
14M-80S-125	80	7	4030	115	4 1/2	356.51	353.71	-	314	215	-	141	32.5	76	32.5	33.40	5306.40
14M-90S-125	90	7	4030	115	4 1/2	401.07	398.27	-	360	215	-	141	32.5	76	32.5	39.40	7947.12
14M-112S-125	112	8	4535	125	5	499.11	496.31	-	456	215	-	141	26	89	26	56.00	17437.76
14M-140S-125	140	8	4535	125	5	623.89	621.09	-	581	215	-	141	26	89	26	73.00	35518.03
14M-168S-125	168	8	5040	125	5	748.66	745.87	-	706	267	-	141	19.5	102	19.5	101.00	70762.02
14M-192S-125	192	8	5040	125	5	855.61	852.82	-	812	267	-	141	19.5	102	19.5	121.50	111182.90

MINIMUM STOCK BORES FOR PLAIN BORED (PB) Sprockets

Sprocket	Minimum Bore	Sprocket	Minimum Bore
	mm		mm
8M-22S-12	12.00	14M-34S-68	40.00
8M-22S-21	12.00	14M-36S-68	40.00
8M-25S-36	16.00	14M-38S-68	40.00
8M-30S-62	20.00	14M-40S-68	40.00
8M-32S-62	20.00	14M-36S-90	50.00
8M-34S-62	20.00	14M-38S-90	50.00
8M-36S-62	20.00	14M-40S-90	50.00
8M-38S-62	20.00	14M-44S-90	50.00
		14M-38S-125	50.00
		14M-40S-125	50.00
		14M-44S-125	50.00
		14M-48S-125	50.00

* Max. bore to be fitted with shallow keys. PB = Plain Bored Bush. For peripheral speeds greater than 40 m/sec consult Gates.



SPROCKETS POLY CHAIN 5MGT/POWERGRIP 5MGT

Description	Number of Grooves	Pitch Diameter	Material	Bore or Bushing	Bore Range		Weight	
		mm			inch	mm	Lbs.	kg
PCGT 5M 18S 15 PB	18	28.66	ST	PB	1/4 - 3/8	6.35 - 9.525	0.24	0.11
PCGT 5M 19S 15 PB	19	30.26	ST	PB	1/4 - 7/16	6.35 - 11.11	0.28	0.13
PCGT 5M 20S 15 PB	20	31.83	ST	PB	1/4 - 1/2	6.35 - 12.7	0.32	0.15
PCGT 5M 21S 15 PB	21	33.43	ST	PB	1/4 - 1/2	6.35 - 12.7	0.36	0.17
PCGT 5M 22S 15 PB	22	35.03	ST	PB	1/4 - 1/2	6.35 - 12.7	0.40	0.19
PCGT 5M 23S 15 PB	23	36.61	ST	PB	3/8 - 5/8	9.525 - 15.875	0.44	0.20
PCGT 5M 24S 15 PB	24	38.21	ST	PB	3/8 - 5/8	9.525 - 15.875	0.47	0.22
PCGT 5M 25S 15 PB	25	39.81	ST	PB	3/8 - 5/8	9.525 - 15.875	0.55	0.25
PCGT 5M 26S 15 PB	26	41.38	ST	PB	3/8 - 11/16	9.525 - 17.46	0.57	0.26
PCGT 5M 28S 15 PB	28	44.58	ST	PB	1/2 - 3/4	12.7 - 19.05	0.67	0.31
PCGT 5M 30S 15 PB	30	47.76	ST	PB	1/2 - 15/16	12.7 - 23.81	0.77	0.35
PCGT 5M 32S 15 PB	32	50.93	ST	PB	1/2 - 15/16	12.7 - 23.81	0.88	0.40
PCGT 5M 34S 15 PB	34	54.11	ST	PB	1 1/2 - 1	12.7 - 25.4	0.95	0.44
PCGT 5M 36S 15 PB	36	57.31	ST	1108	1/2 - 1 1/8	12.7 - 28.575	0.50	0.23
PCGT 5M 36S 15 PB	36	57.31	ST	PB	1/2 - 1	12.7 - 28.575	1.12	0.51
PCGT 5M 38S 15	38	60.48	ST	1108	1/2 - 1 1/8	12.7 - 28.575	0.61	0.28
PCGT 5M 38S 15 PB	38	60.48	ST	PB	1/2 - 1 1/4	12.7 - 31.75	1.35	0.62
PCGT 5M 40S 15	40	63.66	ST	1108	1/2 - 1 1/8	12.7 - 28.575	0.72	0.33
PCGT 5M 40S 15 PB	40	63.66	ST	PB	1/2 - 15/16	12.7 - 1.3125	1.54	0.70
PCGT 5M 44S 15	44	70.03	ST	1108	1/2 - 1 1/8	12.7 - 28.575	0.95	0.44
PCGT 5M 45S 15 PB	45	71.63	ST	PB	1/2 - 1 1/2	12.7 - 38.1	2.00	0.91
PCGT 5M 48S 15	48	76.38	ST	1210	1/2 - 1 1/4	12.7 - 31.75	0.97	0.44
PCGT 5M 50S 15 PB	50	79.08	ST	PB	1/2 - 1 3/4	12.7 - 44.45	2.30	1.05
PCGT 5M 52S 15	52	82.76	DI	1210	1/2 - 1 1/4	12.7 - 31.75	1.17	0.54
PCGT 5M 56S 15	56	89.13	DI	1610	1/2 - 1 11/16	12.7 - 42.8625	1.37	0.63
PCGT 5M 60S 15	60	95.51	DI	1610	1/2 - 1 11/16	12.7 - 42.8625	1.68	0.77
PCGT 5M 64S 15	64	101.86	DI	1610	1/2 - 1 11/16	12.7 - 42.8625	2.17	0.99
PCGT 5M 68S 15	68	108.23	DI	1610	1/2 - 1 11/16	12.7 - 42.8625	2.10	0.96
PCGT 5M 72S 15	72	114.58	DI	1610	1/2 - 1 11/16	12.7 - 42.8625	2.72	1.24
PCGT 5M 80S 15	80	127.34	DI	1610	1/2 - 1 11/16	12.7 - 42.8625	3.15	1.43
PCGT 5M 90S 15	90	143.24	DI	1610	1/2 - 1 11/16	12.7 - 42.8625	4.17	1.90
PCGT 5M 112S 15	112	178.26	DI	2012	1/2 - 2 1/8	12.7 - 53.975	5.16	2.35
PCGT 5M 18S 25 PB	18	28.66	ST	PB	1/4 - 3/8	6.35 - 9.525	0.39	0.18
PCGT 5M 19S 25 PB	19	30.26	ST	PB	1/4 - 7/16	6.35 - 11.11	0.43	0.20
PCGT 5M 20S 25 PB	20	31.83	ST	PB	1/4 - 1/2	6.35 - 12.7	0.47	0.22
PCGT 5M 21S 25 PB	21	33.43	ST	PB	1/4 - 1/2	6.35 - 12.7	0.51	0.24
PCGT 5M 22S 25 PB	22	35.03	ST	PB	1/4 - 1/2	6.35 - 12.7	0.55	0.25
PCGT 5M 23S 25 PB	23	36.61	ST	PB	3/8 - 5/8	9.525 - 15.875	0.59	0.27
PCGT 5M 24S 25 PB	24	38.21	ST	PB	3/8 - 5/8	9.525 - 15.875	0.64	0.30
PCGT 5M 25S 25 PB	25	39.78	ST	PB	3/8 - 5/5	9.525 - 15.875	0.70	0.32
PCGT 5M 26S 25 PB	26	41.38	ST	PB	3/8 - 11/16	9.525 - 17.46	0.76	0.35
PCGT 5M 28S 25 PB	28	44.56	ST	PB	1/2 - 15/16	12.7 - 23.81	0.88	0.40
PCGT 5M 30S 25 PB	30	47.76	ST	PB	1/2 - 15/16	12.7 - 23.81	1.00	0.46
PCGT 5M 32S 25 PB	32	50.93	ST	PB	1/2 - 15/16	12.7 - 23.81	1.16	0.53
PCGT 5M 34S 25 PB	34	54.11	ST	PB	1 1/2 - 1	12.7 - 25.4	1.32	0.60
PCGT 5M 36S 25	36	57.31	ST	1108	1/2 - 1 1/8	12.7 - 28.575	0.72	0.33

POLY CHAIN/
POWERGRIP
SPROCKETS



SPROCKETS POLY CHAIN 5MGT/POWERGRIP 5MGT

Description	Number of Grooves	Pitch Diameter	Material	Bore or Bushing	Bore Range		Weight	
		mm			inch	mm	Lbs.	kg
PCGT 5M 36S 25 PB	36	57.31	ST	PB	1 1/2 - 1	12.7 - 25.4	1.49	0.68
PCGT 5M 38S 25	38	60.48	ST	1108	1/2 - 1 1/8	12.7 - 28.575	0.80	0.37
PCGT 5M 38S 25 PB	38	60.48	ST	PB	1/2 - 1 1/4	12.7 - 31.75	0.79	0.36
PCGT 5M 40S 25	40	63.66	ST	1108	1/2 - 1 1/8	12.7 - 28.575	1.08	0.49
PCGT 5M 40S 25 PB	40	63.6	ST	PB	1/2 - 15/16	12.7 - 1.3125	2.10	0.96
PCGT 5M 44S 25	44	70.03	ST	1108	1/2 - 1 1/8	12.7 - 28.575	1.20	0.55
PCGT 5M 45S 25 PB	45	71.63	ST	PB	1/2 - 1 1/2	12.7 - 38.1	2.65	1.21
PCGT 5M 48S 25	48	76.41	ST	1210	1/2 - 1 1/4	12.7 - 31.75	1.40	0.64
PCGT 5M 50S 25 PB	50	79.58	ST	PB	1/2 - 13/4	12.7 - 44.45	3.00	1.37
PCGT 5M 52S 25	52	82.76	DI	1210	1/2 - 1 1/4	12.7 - 31.75	1.43	0.65
PCGT 5M 56S 25	56	89.13	DI	1610	1/2 - 1 11/16	12.7 - 42.8625	1.64	0.75
PCGT 5M 60S 25	60	95.51	DI	1610	1/2 - 1 11/16	12.7 - 42.8625	1.83	0.84
PCGT 5M 64S 25	64	101.86	DI	1610	1/2 - 1 11/16	12.7 - 42.8625	2.16	0.98
PCGT 5M 68S 25	68	108.23	DI	2012	1/2 - 2 1/8	12.7 - 53.975	2.46	1.12
PCGT 5M 72S 25	72	114.58	DI	2012	1/2 - 2 1/8	12.7 - 53.975	2.84	1.29
PCGT 5M 80S 25	80	127.34	DI	2012	1/2 - 2 1/8	12.7 - 53.975	3.61	1.64
PCGT 5M 90S 25	90	143.24	DI	2012	1/2 - 2 1/8	12.7 - 53.975	4.69	2.13
PCGT 5M 112S 25	112	178.26	DI	2012	1/2 - 2 1/8	12.7 - 53.975	6.02	2.74

NOTE: PB = Plain Bore (Pilot bore).

SPROCKET MATERIALS: ST = Steel; DI = Ductile Iron.



SPROCKETS POLY CHAIN GT STAINLESS STEEL 8MGT

Description	Number of Grooves	Pitch Diameter	Material	Bore or Bushing	Bore Range		Weight	
		mm			Inch	mm	Lbs.	kg
PCGT 8M 28S 12 SS	28	71.310	SS	1108	12.70 - 28.575	1/2 - 1 1/8	0.90	0.41
PCGT 8M 28S 12 SS	28	71.310	SS	PB	12.70 - 44.45	1/2 - 1 3/4	1.40	0.64
PCGT 8M 29S 12 SS	29	73.850	SS	1108	12.70 - 28.575	1/2 - 1 1/8	0.90	0.41
PCGT 8M 29S 12 SS	29	73.850	SS	PB	12.70 - 44.45	1/2 - 1 3/4	1.50	0.69
PCGT 8M 30S 12 SS	30	76.400	SS	1108	12.70 - 28.575	1/2 - 1 1/8	1.00	0.46
PCGT 8M 30S 12 SS	30	76.400	SS	PB	12.70 - 46.0375	1/2 - 1 13/16	1.60	0.73
PCGT 8M 32S 12 SS	32	81.490	SS	1210	12.70 - 31.75	1/2 - 1 1/4	1.20	0.55
PCGT 8M 32S 12 SS	32	81.490	SS	PB	12.70 - 50.8	1/2 - 2	1.70	0.78
PCGT 8M 34S 12 SS	34	86.590	SS	1610	12.70 - 42.8625	1/2 - 1 11/16	1.30	0.59
PCGT 8M 34S 12 SS	34	86.590	SS	PB	12.70 - 53.975	1/2 - 2 1/8	1.80	0.82
PCGT 8M 36S 12 SS	36	91.680	SS	1610	12.70 - 42.8625	1/2 - 1 11/16	1.40	0.64
PCGT 8M 38S 12 SS	38	96.770	SS	1610	12.70 - 42.8625	1/2 - 1 11/16	1.60	0.73
PCGT 8M 40S 12 SS	40	101.860	SS	2012	12.70 - 53.975	1/2 - 2 1/8	1.90	0.87
PCGT 8M 42S 12 SS	42	106.960	SS	2012	12.70 - 53.975	1/2 - 2 1/8	2.30	1.05
PCGT 8M 45S 12 SS	45	114.600	SS	2012	12.70 - 53.975	1/2 - 2 1/8	2.50	1.14
PCGT 8M 48S 12 SS	48	122.240	SS	2012	12.70 - 53.975	1/2 - 2 1/8	2.70	1.23
PCGT 8M 50S 12 SS	50	127.330	SS	2012	12.70 - 53.975	1/2 - 2 1/8	3.90	1.77
PCGT 8M 53S 12 SS	53	134.970	SS	2012	12.70 - 53.975	1/2 - 2 1/8	3.70	1.68
PCGT 8M 56S 12 SS	56	142.610	SS	2012	12.70 - 53.975	1/2 - 2 1/8	4.20	1.91
PCGT 8M 60S 12 SS	60	152.790	SS	2012	12.70 - 53.975	1/2 - 2 1/8	4.90	2.23
PCGT 8M 28S 21 SS	28	71.310	SS	1108	12.70 - 28.575	1/2 - 1 1/8	2.10	0.96
PCGT 8M 28S 21 SS	28	71.310	SS	PB	12.70 - 44.45	1/2 - 1 3/4	1.80	0.82
PCGT 8M 29S 21 SS	29	73.850	SS	1108	12.70 - 28.575	1/2 - 1 1/8	2.30	1.05
PCGT 8M 29S 21 SS	29	73.850	SS	PB	12.70 - 44.45	1/2 - 1 3/4	2.00	0.91
PCGT 8M 30S 21 SS	30	76.400	SS	1108	12.70 - 28.575	1/2 - 1 1/8	2.50	1.14
PCGT 8M 30S 21 SS	30	76.400	SS	PB	12.70 - 46.0375	1/2 - 1 13/16	2.20	1.00
PCGT 8M 32S 21 SS	32	81.490	SS	1210	12.70 - 31.75	1/2 - 1 1/4	3.00	1.37
PCGT 8M 32S 21 SS	32	81.490	SS	PB	12.70 - 50.8	1/2 - 2	2.50	1.14
PCGT 8M 34S 21 SS	34	86.590	SS	1610	12.70 - 42.8625	1/2 - 1 11/16	1.90	0.87
PCGT 8M 34S 21 SS	34	86.590	SS	PB	12.70 - 50.8	1/2 - 2	2.70	1.23
PCGT 8M 36S 21 SS	36	91.680	SS	1610	12.70 - 42.8625	1/2 - 1 11/16	2.10	0.96
PCGT 8M 38S 21 SS	38	96.770	SS	1610	12.70 - 42.8625	1/2 - 1 11/16	2.30	1.05
PCGT 8M 40S 21 SS	40	101.860	SS	2012	12.70 - 53.975	1/2 - 2 1/8	2.30	1.05
PCGT 8M 42S 21 SS	42	106.960	SS	2012	12.70 - 53.975	1/2 - 2 1/8	2.50	1.14
PCGT 8M 45S 21 SS	45	114.600	SS	2012	12.70 - 53.975	1/2 - 2 1/8	3.00	1.37
PCGT 8M 48S 21 SS	48	122.240	SS	2012	12.70 - 53.975	1/2 - 2 1/8	3.40	1.55
PCGT 8M 50S 21 SS	50	127.330	SS	2012	12.70 - 53.975	1/2 - 2 1/8	3.90	1.77
PCGT 8M 53S 21 SS	53	134.970	SS	2012	12.70 - 53.975	1/2 - 2 1/8	4.40	2.00
PCGT 8M 56S 21 SS	56	142.610	SS	2012	12.70 - 53.975	1/2 - 2 1/8	4.80	2.18
PCGT 8M 60S 21 SS	60	152.790	SS	2012	12.70 - 53.975	1/2 - 2 1/8	7.70	3.50

POLY CHAIN
STAINLESS STEEL
SPROCKETS



IDLER SPROCKETS POLY CHAIN GT 8MGT & 14MGT

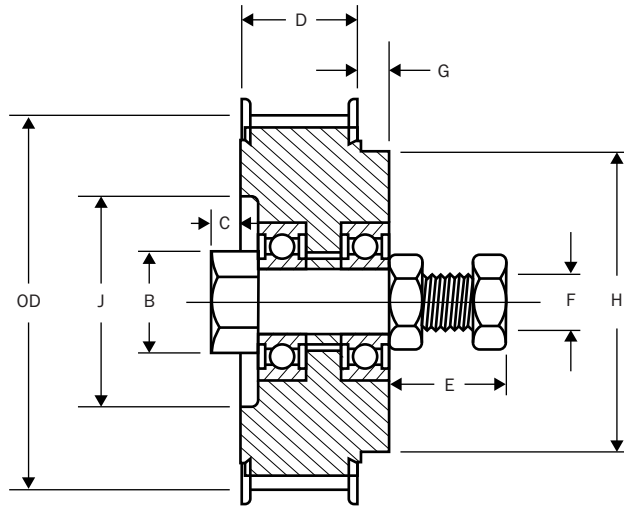

Part PN	Product number	Use with	Use with Bracket	Belt width	No. of teeth	O.D.	B ref.	C	D	E Ref.	G Ref.	H	J	Weight		
				(mm.)		(mm.)	(mm.)	(mm.)	(mm.)	(mm.)	(mm.)	(mm.)	(mm.)	(mm.)	(mm.)	(lb)
PCGT IDLER 8M 32S 12	7720-01500	8mm pitch Poly Chain GT2/ GT Carbon VOLT	7720-01010	12	32	79.88	31.75	12.70	21.59	39.62	3/4-16	23.88	69.85	-	1.00	0.45
PCGT IDLER 8M 32S 21	7720-01510		7720-01010	21	32	79.88	31.75	12.70	31.50	39.62	3/4-16	14.22	69.85	-	1.10	0.50
PCGT IDLER 8M 36S 36	7720-01520		7720-01010	36	36	90.07	48.51	19.05	47.24	41.40	3/4-16	-	-	-	2.00	0.91
PCGT IDLER 8M 36S 62	7720-01530		7720-01010	62	36	90.07	48.51	19.05	73.91	42.93	3/4-16	17.53	79.50	-	2.10	0.95
PCGT IDLER 14M 30S 20	7720-01600	14mm pitch Poly Chain GT2/ GT Carbon VOLT	7720-01020	20	30	130.89	64.77	25.40	34.54	57.15	1-14	25.40	111.25	-	9.00	4.08
PCGT IDLER 14M 30S 37	7720-01610		7720-01020	37	30	130.89	64.77	25.40	52.32	57.15	1-14	6.35	111.25	-	12.00	5.44
PCGT IDLER 14M 34S 68	7720-01620		7720-01020	68	34	148.72	85.85	14.22	84.58	57.15	1-14	25.40	123.95	110.24	15.60	7.08
PCGT IDLER 14M 34S 90	7720-01640		7720-01020	90	34	148.72	85.85	7.87	106.68	57.15	1-14	25.40	123.95	110.24	16.70	7.57
PCGT IDLER 14M 34S 125	7720-01630		7720-01020	125	34	148.72	85.85	4.83	143.00	57.15	1-14	27.69	123.95	110.24	23.10	10.48

POLY CHAIN IDLER SPROCKETS



IDLER BRACKET

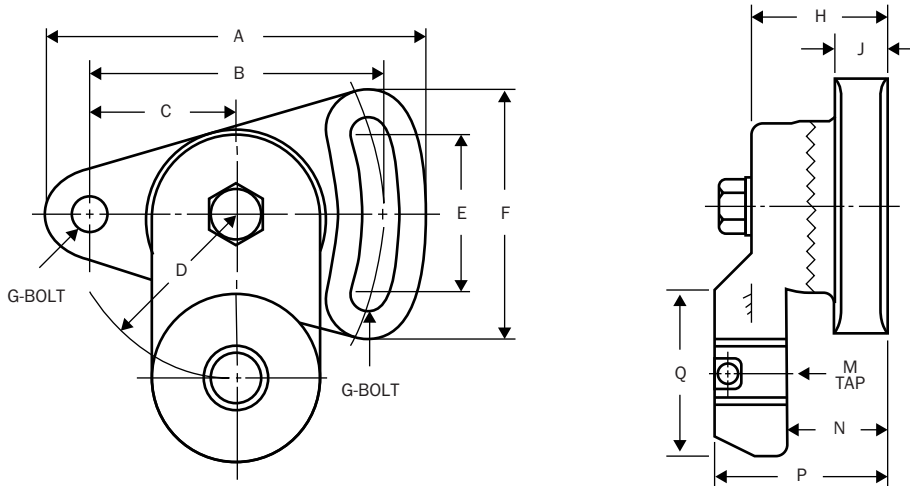

Part PN	Product Number	Use with	A	B	C	D	E	F	G	H	J	Threads	N	P	Q	Weight	
			(mm.)	(mm.)	(mm.)	(mm.)	(mm.)	(mm.)	(mm.)	(mm.)	(mm.)		(mm.)	(mm.)	(mm.)	(mm.)	(lb)
PCGT IDLER BRACKET 10	7720-01010	8mm Pitch Idler Sprockets	117.60	88.90	44.45	50.80	52.32	77.72	9.65	38.10	16.00	3/4-16	25.40	47.75	44.45	3.40	1.54
PCGT IDLER BRACKET 20	7720-01020	14mm Pitch Idler Sprockets	176.28	133.35	66.80	127.00	76.20	115.82	16.00	60.45	25.40	1-14	41.40	74.68	69.85	11.20	5.08

IDLER BRACKET



FLAT IDLER SPROCKET

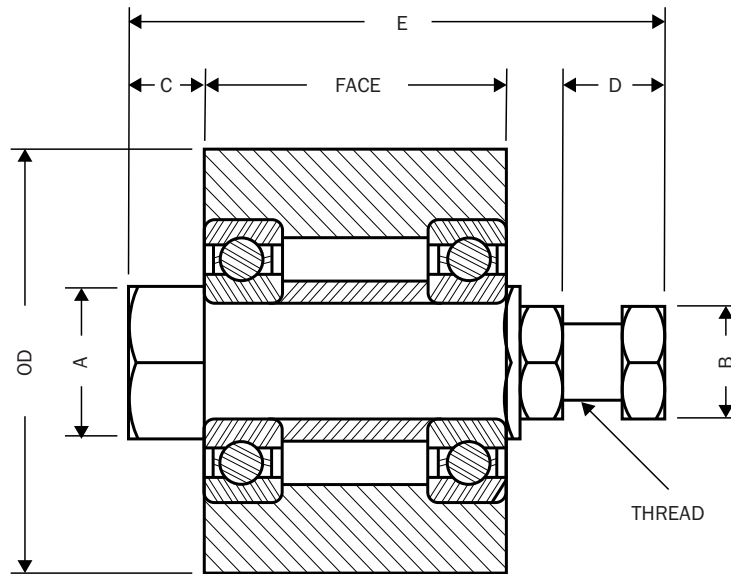

Part PN	Product Number	Use with Bracket	Pitch	Use With Synchronous Belt Width	Use with V-belt	Outside	Face Width	A	B	C	D	E	Thread	Bearing	Weight	
						Dia. (mm)	(mm)	(mm)	(mm)	(mm)	(mm)	(mm)	Size	No.	(lbs)	(Kg)
IDLER FLAT 4.25X1.25	7723-04125	7720-01010	8mm, L, H	Up to 21 mm	XPZ/3VX, XPA (*); SPZ/3V/9J; Z: 1-2 Strand A/AX: 1 Strand; Micro-V PJ: 8 ribs	107.95	31.75	28.71	28.71	16.26	33.02	95.25	3/4-16	6304	5.2	2.36
IDLER FLAT 4.25X2.00	7723-04200	7720-01010	8mm, L, H	Up to 38 mm	XPZ/3VX, XPA (*); SPZ/3V/9J; Z: 3-4 Strand A/AX: 2 Strand; Micro-V PJ: 14 ribs	107.95	50.8	38.1	28.71	16.01	33.53	114.3	3/4-16	6306	7.5	3.41
IDLER FLAT 4.25X3.00	7723-04300	7720-01010	8mm, L, H	Up to 62 mm	XPZ/3VX, XPA (*); SPZ/3V/9J; Z: 5-6 Strand A/AX: 3 Strand; Micro-V PJ: 24 ribs	107.95	76.2	38.1	28.71	19.05	33.53	143.01	3/4-16	6306	10.6	4.81
IDLER FLAT 4.25X4.00	7723-04400	7720-01010	8mm, L, H	Up to 85 mm	XPZ/3VX, XPA (*); SPZ/3V/9J; Z: 8 Strand A/AX: 4 Strand; Micro-V PJ: 34 ribs	107.95	101.6	38.1	28.71	19.05	33.53	168.41	3/4-16	6306	13.6	6.17
IDLER FLAT 6.50X1.75	7723-06175	7720-01020	14mm	Up to 20 mm	XPA, XPB/5VX (*); SPA; A, B, BX: 1 Strand Micro-V PL: 4 ribs	165.1	44.45	50.8	38.1	26.42	49.79	144.53	1-14	6308	17.1	7.76
IDLER FLAT 6.50X2.75	7723-06275	7720-01020	14mm	Up to 55 mm	XPA, XPB/5VX (*); SPA; A, B, BX: 2-3 Strand Micro-V PL: 10 ribs	165.1	69.85	50.8	38.1	3.31	53.34	144.53	1-14	6308	23	10.44
IDLER FLAT 6.50X4.25	7723-06425	7720-01020	14mm	Up to 90 mm	SPA; XPA; XPB/5VX (*); A, B, BX: 4-5 Strand Micro-V PL: 18 ribs	165.1	107.95	60.46	38.1	3.31	50.3	179.33	1-14	6308	33	14.97
IDLER FLAT 6.50X5.75	7723-06575	7720-01020	14mm	Up to 125 mm	XPA, XPB/5VX (*); SPA; A, B, BX: 6 Strand Micro-V PL: 24 ribs	165.1	146.05	60.46	38.1	25.15	50.3	236.48	1-14	6308	45	20.42
IDLER FLAT 6.50X7.50	7723-06750	7720-01020	14mm	Up to 170mm	XPA, XPB/5VX (*); SPA; A, B, BX: 8 Strand Micro-V PL: 34 ribs	165.1	190.5	60.46	38.1	25.4	50.3	284.23	1-14	6308	57.01	25.86

FLAT IDLER SPROCKET



SYNCHRO-POWER T2.5-4 BELT

Part Number	Product Number	Number of Teeth	Pitch Length (mm)	Weight [kg]
T2.5-120-4	7762-10121	48	120	0.001
T2.5-145-4	7762-10141	58	145	0.001
T2.5-160-4	7762-10161	64	160	0.001
T2.5-177.5-4	7762-10171	71	177.5	0.001
T2.5-180-4	7762-10181	72	180	0.001
T2.5-200-4	7762-10201	80	200	0.001
T2.5-230-4	7762-10231	92	230	0.001
T2.5-245-4	7762-10241	98	245	0.001
T2.5-210-4	7762-10251	84	210	0.001
T2.5-265-4	7762-10261	106	265	0.001
T2.5-277.5-4	7762-10271	111	277.5	0.002
T2.5-285-4	7762-10281	114	285	0.002
T2.5-290-4	7762-10291	116	290	0.002
T2.5-305-4	7762-10301	122	305	0.002
T2.5-317.5-4	7762-10311	127	317.5	0.002
T2.5-330-4	7762-10331	132	330	0.002
T2.5-342.5-4	7762-10341	137	342.5	0.002
T2.5-380-4	7762-10381	152	380	0.002
T2.5-420-4	7762-10421	168	420	0.002
T2.5-480-4	7762-10481	192	480	0.003
T2.5-500-4	7762-10501	200	500	0.003
T2.5-540-4	7762-10541	216	540	0.003
T2.5-600-4	7762-10601	240	600	0.003
T2.5-620-4	7762-10621	248	620	0.003
T2.5-650-4	7762-10651	260	650	0.004
T2.5-780-4	7762-10781	312	780	0.004
T2.5-915-4	7762-10911	366	915	0.005
T2.5-950-4	7762-10951	380	950	0.005

SYNCHRO-POWER T2.5-6 BELT

Part Number	Product Number	Number of Teeth	Pitch Length (mm)	Weight [kg]
T2.5-120-6	7762-10122	48	120	0.001
T2.5-145-6	7762-10142	58	145	0.001
T2.5-160-6	7762-10162	64	160	0.001
T2.5-177.5-6	7762-10172	71	177.5	0.001
T2.5-180-6	7762-10182	72	180	0.002
T2.5-200-6	7762-10202	80	200	0.002
T2.5-230-6	7762-10232	92	230	0.002
T2.5-245-6	7762-10242	98	245	0.002
T2.5-210-6	7762-10252	84	210	0.002
T2.5-265-6	7762-10262	106	265	0.002
T2.5-277.5-6	7762-10272	111	277.5	0.002
T2.5-285-6	7762-10282	114	285	0.002
T2.5-290-6	7762-10292	116	290	0.002
T2.5-305-6	7762-10302	122	305	0.003
T2.5-317.5-6	7762-10312	127	317.5	0.003
T2.5-330-6	7762-10332	132	330	0.003
T2.5-342.5-6	7762-10342	137	342.5	0.003
T2.5-380-6	7762-10382	152	380	0.003
T2.5-420-6	7762-10422	168	420	0.004
T2.5-480-6	7762-10482	192	480	0.004
T2.5-500-6	7762-10502	200	500	0.004
T2.5-540-6	7762-10542	216	540	0.005
T2.5-600-6	7762-10602	240	600	0.005
T2.5-620-6	7762-10622	248	620	0.005
T2.5-650-6	7762-10652	260	650	0.005
T2.5-780-6	7762-10782	312	780	0.007
T2.5-915-6	7762-10912	366	915	0.008
T2.5-950-6	7762-10952	380	950	0.008

SYNCHRO-POWER T2.5-8 BELT

Part Number	Product Number	Number of Teeth	Pitch Length (mm)	Weight [kg]
T2.5-120-8	7762-10123	48	120	0.001
T2.5-145-8	7762-10143	58	145	0.002
T2.5-160-8	7762-10163	64	160	0.002
T2.5-177.5-8	7762-10173	71	177.5	0.002
T2.5-180-8	7762-10183	72	180	0.002
T2.5-200-8	7762-10203	80	200	0.002
T2.5-230-8	7762-10233	92	230	0.003
T2.5-245-8	7762-10243	98	245	0.003
T2.5-210-8	7762-10253	84	210	0.002
T2.5-265-8	7762-10263	106	265	0.003
T2.5-277.5-8	7762-10273	111	277.5	0.003
T2.5-285-8	7762-10283	114	285	0.003
T2.5-290-8	7762-10293	116	290	0.003
T2.5-305-8	7762-10303	122	305	0.003
T2.5-317.5-8	7762-10313	127	317.5	0.004
T2.5-330-8	7762-10333	132	330	0.004
T2.5-342.5-8	7762-10343	137	342.5	0.004
T2.5-380-8	7762-10383	152	380	0.004
T2.5-420-8	7762-10423	168	420	0.005
T2.5-480-8	7762-10483	192	480	0.005
T2.5-500-8	7762-10503	200	500	0.006
T2.5-540-8	7762-10543	216	540	0.006
T2.5-600-8	7762-10603	240	600	0.007
T2.5-620-8	7762-10623	248	620	0.007
T2.5-650-8	7762-10653	260	650	0.007
T2.5-780-8	7762-10783	312	780	0.009
T2.5-915-8	7762-10913	366	915	0.01
T2.5-950-8	7762-10953	380	950	0.011

SYNCHRO-POWER T2.5-10 BELT

Part Number	Product Number	Number of Teeth	Pitch Length (mm)	Weight [kg]
T2.5-120-10	7762-10124	48	120	0.002
T2.5-145-10	7762-10144	58	145	0.002
T2.5-160-10	7762-10164	64	160	0.002
T2.5-177.5-10	7762-10174	71	177.5	0.002
T2.5-180-10	7762-10184	72	180	0.003
T2.5-200-10	7762-10204	80	200	0.003
T2.5-230-10	7762-10234	92	230	0.003
T2.5-245-10	7762-10244	98	245	0.003
T2.5-210-10	7762-10254	84	210	0.003
T2.5-265-10	7762-10264	106	265	0.004
T2.5-277.5-10	7762-10274	111	277.5	0.004
T2.5-285-10	7762-10284	114	285	0.004
T2.5-290-10	7762-10294	116	290	0.004
T2.5-305-10	7762-10304	122	305	0.004
T2.5-317.5-10	7762-10314	127	317.5	0.004
T2.5-330-10	7762-10334	132	330	0.005
T2.5-342.5-10	7762-10344	137	342.5	0.005
T2.5-380-10	7762-10384	152	380	0.005
T2.5-420-10	7762-10424	168	420	0.006
T2.5-480-10	7762-10484	192	480	0.007
T2.5-500-10	7762-10504	200	500	0.007
T2.5-540-10	7762-10544	216	540	0.008
T2.5-600-10	7762-10604	240	600	0.008
T2.5-620-10	7762-10624	248	620	0.009
T2.5-650-10	7762-10654	260	650	0.009
T2.5-780-10	7762-10784	312	780	0.011
T2.5-915-10	7762-10914	366	915	0.013
T2.5-950-10	7762-10954	380	950	0.013



SYNCHRO-POWER T2.5-12 BELT

Part Number	Product Number	Number of Teeth	Pitch Length (mm)	Weight [kg]
T2.5-120-12	7762-10125	48	120	0.002
T2.5-145-12	7762-10145	58	145	0.002
T2.5-160-12	7762-10165	64	160	0.003
T2.5-177.5-12	7762-10175	71	177.5	0.003
T2.5-180-12	7762-10185	72	180	0.003
T2.5-200-12	7762-10205	80	200	0.003
T2.5-230-12	7762-10235	92	230	0.004
T2.5-245-12	7762-10245	98	245	0.004
T2.5-210-12	7762-10255	84	210	0.004
T2.5-265-12	7762-10265	106	265	0.004
T2.5-277.5-12	7762-10275	111	277.5	0.005
T2.5-285-12	7762-10285	114	285	0.005
T2.5-290-12	7762-10295	116	290	0.005
T2.5-305-12	7762-10305	122	305	0.005
T2.5-317.5-12	7762-10315	127	317.5	0.005
T2.5-330-12	7762-10335	132	330	0.006
T2.5-342.5-12	7762-10345	137	342.5	0.006
T2.5-380-12	7762-10385	152	380	0.006
T2.5-420-12	7762-10425	168	420	0.007
T2.5-480-12	7762-10485	192	480	0.008
T2.5-500-12	7762-10505	200	500	0.008
T2.5-540-12	7762-10545	216	540	0.009
T2.5-600-12	7762-10605	240	600	0.01
T2.5-620-12	7762-10625	248	620	0.01
T2.5-650-12	7762-10655	260	650	0.011
T2.5-780-12	7762-10785	312	780	0.013
T2.5-915-12	7762-10915	366	915	0.015
T2.5-950-12	7762-10955	380	950	0.016

SYNCHRO-POWER T2.5-16 BELT

Part Number	Product Number	Number of Teeth	Pitch Length (mm)	Weight [kg]
T2.5-120-16	7762-10126	48	120	0.003
T2.5-145-16	7762-10146	58	145	0.003
T2.5-160-16	7762-10166	64	160	0.004
T2.5-177.5-16	7762-10176	71	177.5	0.004
T2.5-180-16	7762-10186	72	180	0.004
T2.5-200-16	7762-10206	80	200	0.004
T2.5-230-16	7762-10236	92	230	0.005
T2.5-245-16	7762-10246	98	245	0.005
T2.5-210-16	7762-10256	84	210	0.005
T2.5-265-16	7762-10266	106	265	0.006
T2.5-277.5-16	7762-10276	111	277.5	0.006
T2.5-285-16	7762-10286	114	285	0.006
T2.5-290-16	7762-10296	116	290	0.006
T2.5-305-16	7762-10306	122	305	0.007
T2.5-317.5-16	7762-10316	127	317.5	0.007
T2.5-330-16	7762-10336	132	330	0.007
T2.5-342.5-16	7762-10346	137	342.5	0.008
T2.5-380-16	7762-10386	152	380	0.009
T2.5-420-16	7762-10426	168	420	0.009
T2.5-480-16	7762-10486	192	480	0.011
T2.5-500-16	7762-10506	200	500	0.011
T2.5-540-16	7762-10546	216	540	0.012
T2.5-600-16	7762-10606	240	600	0.013
T2.5-620-16	7762-10626	248	620	0.014
T2.5-650-16	7762-10656	260	650	0.015
T2.5-780-16	7762-10786	312	780	0.017
T2.5-915-16	7762-10916	366	915	0.02
T2.5-950-16	7762-10956	380	950	0.021



SYNCHRO-POWER T2.5-20 BELT

Part Number	Product Number	Number of Teeth	Pitch Length (mm)	Weight [kg]
T2.5-120-20	7762-10127	48	120	0.003
T2.5-145-20	7762-10147	58	145	0.004
T2.5-160-20	7762-10167	64	160	0.004
T2.5-177.5-20	7762-10177	71	177.5	0.005
T2.5-180-20	7762-10187	72	180	0.005
T2.5-200-20	7762-10207	80	200	0.006
T2.5-230-20	7762-10237	92	230	0.006
T2.5-245-20	7762-10247	98	245	0.007
T2.5-210-20	7762-10257	84	210	0.006
T2.5-265-20	7762-10267	106	265	0.007
T2.5-277.5-20	7762-10277	111	277.5	0.008
T2.5-285-20	7762-10287	114	285	0.008
T2.5-290-20	7762-10297	116	290	0.008
T2.5-305-20	7762-10307	122	305	0.009
T2.5-317.5-20	7762-10317	127	317.5	0.009
T2.5-330-20	7762-10337	132	330	0.009
T2.5-342.5-20	7762-10347	137	342.5	0.01
T2.5-380-20	7762-10387	152	380	0.011
T2.5-420-20	7762-10427	168	420	0.012
T2.5-480-20	7762-10487	192	480	0.013
T2.5-500-20	7762-10507	200	500	0.014
T2.5-540-20	7762-10547	216	540	0.015
T2.5-600-20	7762-10607	240	600	0.017
T2.5-620-20	7762-10627	248	620	0.017
T2.5-650-20	7762-10657	260	650	0.018
T2.5-780-20	7762-10787	312	780	0.022
T2.5-915-20	7762-10917	366	915	0.026
T2.5-950-20	7762-10957	380	950	0.027

SYNCHRO-POWER T2.5-25 BELT

Part Number	Product Number	Number of Teeth	Pitch Length (mm)	Weight [kg]
T2.5-120-25	7762-10128	48	120	0.004
T2.5-145-25	7762-10148	58	145	0.005
T2.5-160-25	7762-10168	64	160	0.006
T2.5-177.5-25	7762-10178	71	177.5	0.006
T2.5-180-25	7762-10188	72	180	0.006
T2.5-200-25	7762-10208	80	200	0.007
T2.5-230-25	7762-10238	92	230	0.008
T2.5-245-25	7762-10248	98	245	0.009
T2.5-210-25	7762-10258	84	210	0.007
T2.5-265-25	7762-10268	106	265	0.009
T2.5-277.5-25	7762-10278	111	277.5	0.01
T2.5-285-25	7762-10288	114	285	0.01
T2.5-290-25	7762-10298	116	290	0.01
T2.5-305-25	7762-10308	122	305	0.011
T2.5-317.5-25	7762-10318	127	317.5	0.011
T2.5-330-25	7762-10338	132	330	0.012
T2.5-342.5-25	7762-10348	137	342.5	0.012
T2.5-380-25	7762-10388	152	380	0.013
T2.5-420-25	7762-10428	168	420	0.015
T2.5-480-25	7762-10488	192	480	0.017
T2.5-500-25	7762-10508	200	500	0.018
T2.5-540-25	7762-10548	216	540	0.019
T2.5-600-25	7762-10608	240	600	0.021
T2.5-620-25	7762-10628	248	620	0.022
T2.5-650-25	7762-10658	260	650	0.023
T2.5-780-25	7762-10788	312	780	0.027
T2.5-915-25	7762-10918	366	915	0.032
T2.5-950-25	7762-10958	380	950	0.033



SYNCHRO-POWER T2.5-32 BELT

Part Number	Product Number	Number of Teeth	Pitch Length (mm)	Weight [kg]
T2.5-120-32	7762-10129	48	120	0.005
T2.5-145-32	7762-10149	58	145	0.006
T2.5-160-32	7762-10169	64	160	0.007
T2.5-177.5-32	7762-10179	71	177.5	0.008
T2.5-180-32	7762-10189	72	180	0.008
T2.5-200-32	7762-10209	80	200	0.009
T2.5-230-32	7762-10239	92	230	0.01
T2.5-245-32	7762-10249	98	245	0.011
T2.5-210-32	7762-10259	84	210	0.009
T2.5-265-32	7762-10269	106	265	0.012
T2.5-277.5-32	7762-10279	111	277.5	0.012
T2.5-285-32	7762-10289	114	285	0.013
T2.5-290-32	7762-10299	116	290	0.013
T2.5-305-32	7762-10309	122	305	0.014
T2.5-317.5-32	7762-10319	127	317.5	0.014
T2.5-330-32	7762-10339	132	330	0.015
T2.5-342.5-32	7762-10349	137	342.5	0.015
T2.5-380-32	7762-10389	152	380	0.017
T2.5-420-32	7762-10429	168	420	0.019
T2.5-480-32	7762-10489	192	480	0.022
T2.5-500-32	7762-10509	200	500	0.022
T2.5-540-32	7762-10549	216	540	0.024
T2.5-600-32	7762-10609	240	600	0.027
T2.5-620-32	7762-10629	248	620	0.028
T2.5-650-32	7762-10659	260	650	0.029
T2.5-780-32	7762-10789	312	780	0.035
T2.5-915-32	7762-10919	366	915	0.041
T2.5-950-32	7762-10959	380	950	0.043

SYNCHRO-POWER T2.5-50 BELT

Part Number	Product Number	Number of Teeth	Pitch Length (mm)	Weight [kg]
T2.5-120-50	7762-10130	48	120	0.008
T2.5-145-50	7762-10150	58	145	0.01
T2.5-160-50	7762-10170	64	160	0.011
T2.5-177.5-50	7762-10180	71	177.5	0.001
T2.5-180-50	7762-10190	72	180	0.013
T2.5-200-50	7762-10210	80	200	0.001
T2.5-230-50	7762-10240	92	230	0.016
T2.5-245-50	7762-10250	98	245	0.017
T2.5-210-50	7762-10260	84	210	0.015
T2.5-265-50	7762-10270	106	265	0.019
T2.5-277.5-50	7762-10280	111	277.5	0.019
T2.5-285-50	7762-10290	114	285	0.02
T2.5-290-50	7762-10300	116	290	0.02
T2.5-305-50	7762-10310	122	305	0.021
T2.5-317.5-50	7762-10320	127	317.5	0.022
T2.5-330-50	7762-10340	132	330	0.023
T2.5-342.5-50	7762-10350	137	342.5	0.024
T2.5-380-50	7762-10390	152	380	0.027
T2.5-420-50	7762-10430	168	420	0.029
T2.5-480-50	7762-10490	192	480	0.034
T2.5-500-50	7762-10510	200	500	0.035
T2.5-540-50	7762-10550	216	540	0.038
T2.5-600-50	7762-10610	240	600	0.042
T2.5-620-50	7762-10630	248	620	0.043
T2.5-650-50	7762-10660	260	650	0.046
T2.5-780-50	7762-10790	312	780	0.055
T2.5-915-50	7762-10920	366	915	0.064
T2.5-950-50	7762-10960	380	950	0.067

SYNCHRO-POWER T2.5-SLEEVE

Part Number	Product Number	Number of Teeth	Pitch Length (mm)	Weight [kg]	Sleeve Width [mm]	Cord
T2.5-120	7761-10120	48	120	0.034	200	Steel
T2.5-145	7761-10145	58	145	0.041	200	Steel
T2.5-160	7761-10160	64	160	0.045	200	Steel
T2.5-177.5	7761-10177	71	177.5	0.05	200	Steel
T2.5-180	7761-10180	72	180	0.05	200	Steel
T2.5-200	7761-10200	80	200	0.056	200	Steel
T2.5-210	7761-10210	84	210	0.059	200	Steel
T2.5-230	7761-10230	92	230	0.064	200	Steel
T2.5-245	7761-10245	98	245	0.069	200	Steel
T2.5-265	7761-10265	106	265	0.074	200	Steel
T2.5-277.5	7761-10277	111	277.5	0.078	200	Steel
T2.5-285	7761-10285	114	285	0.08	200	Steel
T2.5-290	7761-10290	116	290	0.081	200	Steel
T2.5-305	7761-10305	122	305	0.085	200	Steel
T2.5-317.5	7761-10317	127	317.5	0.089	200	Steel
T2.5-330	7761-10329	132	330	0.176	380	Steel
T2.5-342.5	7761-10341	137	342.5	0.182	380	Steel
T2.5-380	7761-10379	152	380	0.202	380	Steel
T2.5-420	7761-10419	168	420	0.223	380	Steel
T2.5-480	7761-10479	192	480	0.255	380	Steel
T2.5-500	7761-10499	200	500	0.266	380	Steel
T2.5-540	7761-10539	216	540	0.287	380	Steel
T2.5-600	7761-10599	240	600	0.319	380	Steel
T2.5-620	7761-10619	248	620	0.33	380	Steel
T2.5-650	7761-10649	260	650	0.346	380	Steel
T2.5-780	7761-10779	312	780	0.415	380	Steel
T2.5-915	7761-10914	366	915	0.487	380	Steel
T2.5-950	7761-10949	380	950	0.505	380	Steel
T2.5-120-AR	7761-10122	48	120	0.034	200	Aramid
T2.5-145-AR	7761-10142	58	145	0.041	200	Aramid
T2.5-160-AR	7761-10162	64	160	0.045	200	Aramid
T2.5-177.5-AR	7761-10172	71	177.5	0.05	200	Aramid
T2.5-180-AR	7761-10182	72	180	0.05	200	Aramid
T2.5-200-AR	7761-10202	80	200	0.056	200	Aramid
T2.5-210-AR	7761-10212	84	210	0.059	200	Aramid
T2.5-230-AR	7761-10232	92	230	0.064	200	Aramid
T2.5-245-AR	7761-10242	98	245	0.069	200	Aramid
T2.5-265-AR	7761-10262	106	265	0.074	200	Aramid
T2.5-277.5-AR	7761-10272	111	277.5	0.078	200	Aramid
T2.5-285-AR	7761-10282	114	285	0.08	200	Aramid
T2.5-290-AR	7761-10292	116	290	0.081	200	Aramid
T2.5-305-AR	7761-10302	122	305	0.085	200	Aramid
T2.5-317.5-AR	7761-10312	127	317.5	0.089	200	Aramid
T2.5-330-AR	7761-10322	132	330	0.176	380	Aramid
T2.5-342.5-AR	7761-10342	137	342.5	0.182	380	Aramid
T2.5-380-AR	7761-10372	152	380	0.202	380	Aramid
T2.5-420-AR	7761-10412	168	420	0.223	380	Aramid
T2.5-480-AR	7761-10472	192	480	0.255	380	Aramid
T2.5-500-AR	7761-10492	200	500	0.266	380	Aramid
T2.5-540-AR	7761-10532	216	540	0.287	380	Aramid
T2.5-600-AR	7761-10592	240	600	0.319	380	Aramid
T2.5-620-AR	7761-10612	248	620	0.33	380	Aramid
T2.5-650-AR	7761-10642	260	650	0.346	380	Aramid
T2.5-780-AR	7761-10772	312	780	0.415	380	Aramid
T2.5-915-AR	7761-10912	366	915	0.487	380	Aramid
T2.5-950-AR	7761-10942	380	950	0.505	380	Aramid



SYNCHRO-POWER T5-4 BELT

Part Number	Product Number	Number of Teeth	Pitch Length (mm)	Weight [kg]
T5-165-4	7762-20162	33	165	0.001
T5-185-4	7762-20191	37	185	0.002
T5-200-4	7762-20220	40	200	0.002
T5-215-4	7762-29232	43	215	0.002
T5-220-4	7762-20231	44	220	0.002
T5-225-4	7762-29231	45	225	0.002
T5-245-4	7762-20323	49	245	0.002
T5-250-4	7762-20324	50	250	0.002
T5-255-4	7762-29261	51	255	0.002
T5-260-4	7762-20325	52	260	0.002
T5-270-4	7762-20326	54	270	0.002
T5-275-4	7762-29281	55	275	0.002
T5-280-4	7762-20327	56	280	0.002
T5-295-4	7762-20328	59	295	0.002
T5-300-4	7762-29311	60	300	0.003
T5-305-4	7762-20311	61	305	0.003
T5-320-4	7762-29314	64	320	0.003
T5-325-4	7762-20236	65	325	0.003
T5-330-4	7762-20329	66	330	0.003
T5-340-4	7762-20330	68	340	0.003
T5-350-4	7762-20372	70	350	0.003
T5-355-4	7762-29361	71	355	0.003
T5-365-4	7762-20371	73	365	0.003
T5-375-4	7762-20381	75	375	0.003
T5-390-4	7762-20432	78	390	0.003
T5-400-4	7762-20433	80	400	0.003
T5-410-4	7762-20434	82	410	0.003
T5-420-4	7762-20431	84	420	0.004
T5-425-4	7762-29431	85	425	0.004
T5-430-4	7762-20762	86	430	0.004
T5-440-4	7762-29439	88	440	0.004
T5-445-4	7762-20441	89	445	0.004
T5-450-4	7762-29461	90	450	0.004
T5-455-4	7762-20461	91	455	0.004
T5-460-4	7762-29471	92	460	0.004
T5-475-4	7762-20436	95	475	0.004
T5-480-4	7762-20491	96	480	0.004
T5-500-4	7762-20532	100	500	0.004
T5-510-4	7762-20533	102	510	0.004
T5-525-4	7762-20531	105	525	0.004
T5-545-4	7762-20582	109	545	0.005
T5-550-4	7762-20583	110	550	0.005
T5-560-4	7762-20584	112	560	0.005
T5-575-4	7762-20581	115	575	0.005
T5-590-4	7762-20585	118	590	0.005
T5-600-4	7762-20688	120	600	0.005

Part Number	Product Number	Number of Teeth	Pitch Length (mm)	Weight [kg]
T5-610-4	7762-20682	122	610	0.005
T5-620-4	7762-20683	124	620	0.005
T5-625-4	7762-20779	125	625	0.005
T5-630-4	7762-20684	126	630	0.005
T5-640-4	7762-20685	128	640	0.005
T5-650-4	7762-20686	130	650	0.005
T5-660-4	7762-20687	132	660	0.006
T5-675-4	7762-20681	138	675	0.003
T5-690-4	7762-20712	138	690	0.006
T5-700-4	7762-20711	140	700	0.006
T5-720-4	7762-20731	144	720	0.006
T5-725-4	7762-20716	145	725	0.006
T5-750-4	7762-20761	150	750	0.006
T5-780-4	7762-20791	156	780	0.007
T5-800-4	7762-20792	160	800	0.007
T5-815-4	7762-20821	163	815	0.007
T5-840-4	7762-20851	168	840	0.007
T5-850-4	7762-20838	170	850	0.007
T5-900-4	7762-20911	180	900	0.008
T5-940-4	7762-20951	188	940	0.008
T5-990-4	7762-21001	198	990	0.008
T5-1000-4	7762-21011	200	1000	0.008
T5-1075-4	7762-21081	215	1075	0.009
T5-1100-4	7762-21111	220	1100	0.009
T5-1215-4	7762-21221	243	1215	0.01
T5-1315-4	7762-21321	263	1315	0.011
T5-1350-4	7762-21361	270	1350	0.011
T5-1380-4	7762-21391	276	1380	0.012
T5-1440-4	7762-21451	288	1440	0.012

SYNCHRO-POWER T5-6 BELT

Part Number	Product Number	Number of Teeth	Pitch Length (mm)	Weight [kg]
T5-165-6	7762-20163	33	165	0.002
T5-185-6	7762-20181	37	185	0.002
T5-200-6	7762-20201	40	200	0.003
T5-215-6	7762-29211	43	215	0.003
T5-220-6	7762-20221	44	220	0.003
T5-225-6	7762-29221	45	225	0.003
T5-245-6	7762-20241	49	245	0.003
T5-250-6	7762-20251	50	250	0.003
T5-255-6	7762-29251	51	255	0.003
T5-260-6	7762-20261	52	260	0.003
T5-270-6	7762-20271	54	270	0.003
T5-275-6	7762-29271	55	275	0.003
T5-280-6	7762-20281	56	280	0.004
T5-295-6	7762-20291	59	295	0.004
T5-300-6	7762-29301	60	300	0.004
T5-305-6	7762-20301	61	305	0.004
T5-320-6	7762-29321	64	320	0.004
T5-325-6	7762-20239	65	325	0.004
T5-330-6	7762-20331	66	330	0.004
T5-340-6	7762-20341	68	340	0.004
T5-350-6	7762-20351	70	350	0.004
T5-355-6	7762-29351	71	355	0.004
T5-365-6	7762-20361	73	365	0.005
T5-375-6	7762-20382	75	375	0.005
T5-390-6	7762-20391	78	390	0.005
T5-400-6	7762-20401	80	400	0.005
T5-410-6	7762-20411	82	410	0.005
T5-420-6	7762-20421	84	420	0.005
T5-425-6	7762-29421	85	425	0.005
T5-430-6	7762-20763	86	430	0.005
T5-440-6	7762-29441	88	440	0.006
T5-445-6	7762-20442	89	445	0.006
T5-450-6	7762-29451	90	450	0.006
T5-455-6	7762-20451	91	455	0.006
T5-460-6	7762-20772	92	460	0.006
T5-475-6	7762-20471	95	475	0.006
T5-480-6	7762-20481	96	480	0.006
T5-500-6	7762-20501	100	500	0.006
T5-510-6	7762-20511	102	510	0.006
T5-525-6	7762-20521	105	525	0.007
T5-545-6	7762-20541	109	545	0.007
T5-550-6	7762-20551	110	550	0.007
T5-560-6	7762-20561	112	560	0.007
T5-575-6	7762-20571	115	575	0.007
T5-590-6	7762-20591	118	590	0.007
T5-600-6	7762-20601	120	600	0.008
T5-610-6	7762-20611	122	610	0.008

Part Number	Product Number	Number of Teeth	Pitch Length (mm)	Weight [kg]
T5-620-6	7762-20621	124	620	0.008
T5-625-6	7762-20741	125	625	0.008
T5-630-6	7762-20631	126	630	0.008
T5-640-6	7762-20641	128	640	0.008
T5-650-6	7762-20651	130	650	0.008
T5-660-6	7762-20661	132	660	0.008
T5-675-6	7762-20671	138	675	0.004
T5-690-6	7762-20691	138	690	0.009
T5-700-6	7762-20701	140	700	0.009
T5-720-6	7762-20721	144	720	0.009
T5-725-6	7762-20732	145	725	0.009
T5-750-6	7762-20751	150	750	0.009
T5-780-6	7762-20781	156	780	0.01
T5-800-6	7762-20801	160	800	0.01
T5-815-6	7762-20811	163	815	0.01
T5-840-6	7762-20841	168	840	0.011
T5-850-6	7762-20852	170	850	0.011
T5-900-6	7762-20901	180	900	0.011
T5-940-6	7762-20941	188	940	0.012
T5-990-6	7762-20991	198	990	0.012
T5-1000-6	7762-21012	200	1000	0.013
T5-1075-6	7762-21071	215	1075	0.014
T5-1100-6	7762-21101	220	1100	0.014
T5-1215-6	7762-21211	243	1215	0.015
T5-1315-6	7762-21311	263	1315	0.017
T5-1350-6	7762-21351	270	1350	0.017
T5-1380-6	7762-21381	276	1380	0.017
T5-1440-6	7762-21441	288	1440	0.018



SYNCHRO-POWER T5-8 BELT

Part Number	Product Number	Number of Teeth	Pitch Length (mm)	Weight [kg]
T5-165-8	7762-20164	33	165	0.003
T5-185-8	7762-20182	37	185	0.003
T5-200-8	7762-20202	40	200	0.003
T5-215-8	7762-29212	43	215	0.004
T5-220-8	7762-20222	44	220	0.004
T5-225-8	7762-29222	45	225	0.004
T5-245-8	7762-20242	49	245	0.004
T5-250-8	7762-20252	50	250	0.004
T5-255-8	7762-29252	51	255	0.004
T5-260-8	7762-20262	52	260	0.004
T5-270-8	7762-20272	54	270	0.005
T5-275-8	7762-29272	55	275	0.005
T5-280-8	7762-20282	56	280	0.005
T5-295-8	7762-20292	59	295	0.005
T5-300-8	7762-29302	60	300	0.005
T5-305-8	7762-20302	61	305	0.005
T5-320-8	7762-29322	64	320	0.005
T5-325-8	7762-20240	65	325	0.005
T5-330-8	7762-20332	66	330	0.006
T5-340-8	7762-20342	68	340	0.006
T5-350-8	7762-20352	70	350	0.006
T5-355-8	7762-29352	71	355	0.006
T5-365-8	7762-20362	73	365	0.006
T5-375-8	7762-20383	75	375	0.006
T5-390-8	7762-20392	78	390	0.007
T5-400-8	7762-20402	80	400	0.007
T5-410-8	7762-20412	82	410	0.007
T5-420-8	7762-20422	84	420	0.007
T5-425-8	7762-29422	85	425	0.007
T5-430-8	7762-20764	86	430	0.007
T5-440-8	7762-29442	88	440	0.007
T5-445-8	7762-20443	89	445	0.007
T5-450-8	7762-29452	90	450	0.008
T5-455-8	7762-20452	91	455	0.008
T5-460-8	7762-20462	92	460	0.008
T5-475-8	7762-20472	95	475	0.008
T5-480-8	7762-20482	96	480	0.008
T5-500-8	7762-20502	100	500	0.008
T5-510-8	7762-20512	102	510	0.009
T5-525-8	7762-20522	105	525	0.009
T5-545-8	7762-20542	109	545	0.009
T5-550-8	7762-20552	110	550	0.009
T5-560-8	7762-20562	112	560	0.009
T5-575-8	7762-20572	115	575	0.01
T5-590-8	7762-20592	118	590	0.01
T5-600-8	7762-20689	120	600	0.01
T5-610-8	7762-20612	122	610	0.01

Part Number	Product Number	Number of Teeth	Pitch Length (mm)	Weight [kg]
T5-620-8	7762-20622	124	620	0.01
T5-625-8	7762-20743	125	625	0.011
T5-630-8	7762-20632	126	630	0.011
T5-640-8	7762-20642	128	640	0.011
T5-650-8	7762-20652	130	650	0.011
T5-660-8	7762-20662	132	660	0.011
T5-675-8	7762-20672	138	675	0.006
T5-690-8	7762-20692	138	690	0.012
T5-700-8	7762-20702	140	700	0.012
T5-720-8	7762-20722	144	720	0.012
T5-725-8	7762-20717	145	725	0.012
T5-750-8	7762-20752	150	750	0.013
T5-780-8	7762-20782	156	780	0.013
T5-800-8	7762-20793	160	800	0.013
T5-815-8	7762-20812	163	815	0.014
T5-840-8	7762-20842	168	840	0.014
T5-850-8	7762-20863	170	850	0.014
T5-900-8	7762-20902	180	900	0.015
T5-940-8	7762-20942	188	940	0.016
T5-990-8	7762-20992	198	990	0.017
T5-1000-8	7762-21002	200	1000	0.017
T5-1075-8	7762-21072	215	1075	0.018
T5-1100-8	7762-21102	220	1100	0.018
T5-1215-8	7762-21212	243	1215	0.02
T5-1315-8	7762-21312	263	1315	0.022
T5-1350-8	7762-21352	270	1350	0.023
T5-1380-8	7762-21382	276	1380	0.023
T5-1440-8	7762-21442	288	1440	0.024

SYNCHRO-POWER T5-10 BELT

Part Number	Product Number	Number of Teeth	Pitch Length (mm)	Weight [kg]
T5-165-10	7762-20173	33	165	0.003
T5-185-10	7762-20183	37	185	0.004
T5-200-10	7762-20203	40	200	0.004
T5-215-10	7762-29213	43	215	0.005
T5-220-10	7762-20223	44	220	0.005
T5-225-10	7762-29223	45	225	0.005
T5-245-10	7762-20243	49	245	0.005
T5-250-10	7762-20253	50	250	0.005
T5-255-10	7762-29253	51	255	0.005
T5-260-10	7762-20263	52	260	0.005
T5-270-10	7762-20273	54	270	0.006
T5-275-10	7762-29273	55	275	0.006
T5-280-10	7762-20283	56	280	0.006
T5-295-10	7762-20293	59	295	0.006
T5-300-10	7762-29303	60	300	0.006
T5-305-10	7762-20303	61	305	0.006
T5-320-10	7762-29323	64	320	0.007
T5-325-10	7762-20174	65	325	0.007
T5-330-10	7762-20333	66	330	0.007
T5-340-10	7762-20343	68	340	0.007
T5-350-10	7762-20353	70	350	0.007
T5-355-10	7762-29353	71	355	0.007
T5-365-10	7762-20363	73	365	0.008
T5-375-10	7762-20373	75	375	0.008
T5-390-10	7762-20393	78	390	0.008
T5-400-10	7762-20403	80	400	0.008
T5-410-10	7762-20413	82	410	0.009
T5-420-10	7762-20423	84	420	0.009
T5-425-10	7762-29423	85	425	0.009
T5-430-10	7762-20765	86	430	0.009
T5-440-10	7762-29443	88	440	0.009
T5-445-10	7762-20444	89	445	0.009
T5-450-10	7762-29453	90	450	0.009
T5-455-10	7762-20453	91	455	0.01
T5-460-10	7762-20463	92	460	0.01
T5-475-10	7762-20473	95	475	0.01
T5-480-10	7762-20483	96	480	0.01
T5-500-10	7762-20503	100	500	0.011
T5-510-10	7762-20513	102	510	0.011
T5-525-10	7762-20523	105	525	0.011
T5-545-10	7762-20543	109	545	0.011
T5-550-10	7762-20553	110	550	0.012
T5-560-10	7762-20563	112	560	0.012
T5-575-10	7762-20573	115	575	0.012
T5-590-10	7762-20593	118	590	0.012
T5-600-10	7762-20602	120	600	0.013
T5-610-10	7762-20613	122	610	0.013

Part Number	Product Number	Number of Teeth	Pitch Length (mm)	Weight [kg]
T5-620-10	7762-20623	124	620	0.013
T5-625-10	7762-20773	125	625	0.013
T5-630-10	7762-20633	126	630	0.013
T5-640-10	7762-20643	128	640	0.013
T5-650-10	7762-20653	130	650	0.014
T5-660-10	7762-20663	132	660	0.014
T5-675-10	7762-20673	138	675	0.007
T5-690-10	7762-20693	138	690	0.014
T5-700-10	7762-20703	140	700	0.015
T5-720-10	7762-20723	144	720	0.015
T5-725-10	7762-20733	145	725	0.015
T5-750-10	7762-20753	150	750	0.016
T5-780-10	7762-20783	156	780	0.016
T5-800-10	7762-20802	160	800	0.017
T5-815-10	7762-20813	163	815	0.017
T5-840-10	7762-20843	168	840	0.018
T5-850-10	7762-20853	170	850	0.018
T5-900-10	7762-20903	180	900	0.019
T5-940-10	7762-20943	188	940	0.02
T5-990-10	7762-20993	198	990	0.021
T5-1000-10	7762-21003	200	1000	0.021
T5-1075-10	7762-21073	215	1075	0.023
T5-1100-10	7762-21103	220	1100	0.023
T5-1215-10	7762-21213	243	1215	0.026
T5-1315-10	7762-21313	263	1315	0.028
T5-1350-10	7762-21353	270	1350	0.028
T5-1380-10	7762-21383	276	1380	0.029
T5-1440-10	7762-21443	288	1440	0.03



SYNCHRO-POWER T5-12 BELT

Part Number	Product Number	Number of Teeth	Pitch Length (mm)	Weight [kg]
T5-165-12	7762-20166	33	165	0.004
T5-185-12	7762-20184	37	185	0.005
T5-200-12	7762-20204	40	200	0.005
T5-215-12	7762-29214	43	215	0.005
T5-220-12	7762-20224	44	220	0.006
T5-225-12	7762-29224	45	225	0.006
T5-245-12	7762-20244	49	245	0.006
T5-250-12	7762-20254	50	250	0.006
T5-255-12	7762-29254	51	255	0.006
T5-260-12	7762-20264	52	260	0.007
T5-270-12	7762-20274	54	270	0.007
T5-275-12	7762-29274	55	275	0.007
T5-280-12	7762-20284	56	280	0.007
T5-295-12	7762-20294	59	295	0.007
T5-300-12	7762-29304	60	300	0.008
T5-305-12	7762-20304	61	305	0.008
T5-320-12	7762-29324	64	320	0.008
T5-325-12	7762-20175	65	325	0.008
T5-330-12	7762-20334	66	330	0.008
T5-340-12	7762-20344	68	340	0.009
T5-350-12	7762-20354	70	350	0.009
T5-355-12	7762-29354	71	355	0.009
T5-365-12	7762-20364	73	365	0.009
T5-375-12	7762-20374	75	375	0.009
T5-390-12	7762-20394	78	390	0.01
T5-400-12	7762-20404	80	400	0.01
T5-410-12	7762-20414	82	410	0.01
T5-420-12	7762-20424	84	420	0.011
T5-425-12	7762-29424	85	425	0.011
T5-430-12	7762-20766	86	430	0.011
T5-440-12	7762-29444	88	440	0.011
T5-445-12	7762-20445	89	445	0.011
T5-450-12	7762-29454	90	450	0.011
T5-455-12	7762-20454	91	455	0.011
T5-460-12	7762-20464	92	460	0.012
T5-475-12	7762-20474	95	475	0.012
T5-480-12	7762-20484	96	480	0.012
T5-500-12	7762-20504	100	500	0.013
T5-510-12	7762-20514	102	510	0.013
T5-525-12	7762-20524	105	525	0.013
T5-545-12	7762-20544	109	545	0.014
T5-550-12	7762-20554	110	550	0.014
T5-560-12	7762-20564	112	560	0.014
T5-575-12	7762-20574	115	575	0.014
T5-590-12	7762-20594	118	590	0.015
T5-600-12	7762-20713	120	600	0.015
T5-610-12	7762-20614	122	610	0.015

Part Number	Product Number	Number of Teeth	Pitch Length (mm)	Weight [kg]
T5-620-12	7762-20624	124	620	0.016
T5-625-12	7762-20774	125	625	0.016
T5-630-12	7762-20634	126	630	0.016
T5-640-12	7762-20644	128	640	0.016
T5-650-12	7762-20654	130	650	0.016
T5-660-12	7762-20664	132	660	0.017
T5-675-12	7762-20674	138	675	0.009
T5-690-12	7762-20694	138	690	0.017
T5-700-12	7762-20704	140	700	0.018
T5-720-12	7762-20724	144	720	0.018
T5-725-12	7762-20718	145	725	0.018
T5-750-12	7762-20754	150	750	0.019
T5-780-12	7762-20784	156	780	0.02
T5-800-12	7762-20794	160	800	0.02
T5-815-12	7762-20814	163	815	0.021
T5-840-12	7762-20844	168	840	0.021
T5-850-12	7762-20864	170	850	0.021
T5-900-12	7762-20904	180	900	0.023
T5-940-12	7762-20944	188	940	0.024
T5-990-12	7762-20994	198	990	0.025
T5-1000-12	7762-21004	200	1000	0.025
T5-1075-12	7762-21074	215	1075	0.027
T5-1100-12	7762-21104	220	1100	0.028
T5-1215-12	7762-21214	243	1215	0.031
T5-1315-12	7762-21314	263	1315	0.033
T5-1350-12	7762-21354	270	1350	0.034
T5-1380-12	7762-21384	276	1380	0.035
T5-1440-12	7762-21444	288	1440	0.036

SYNCHRO-POWER T5-16 BELT

Part Number	Product Number	Number of Teeth	Pitch Length (mm)	Weight [kg]
T5-165-16	7762-20167	33	165	0.006
T5-185-16	7762-20185	37	185	0.006
T5-200-16	7762-20205	40	200	0.007
T5-215-16	7762-29215	43	215	0.007
T5-220-16	7762-20225	44	220	0.007
T5-225-16	7762-29225	45	225	0.008
T5-245-16	7762-20245	49	245	0.008
T5-250-16	7762-20255	50	250	0.008
T5-255-16	7762-29255	51	255	0.009
T5-260-16	7762-20265	52	260	0.009
T5-270-16	7762-20275	54	270	0.009
T5-275-16	7762-29275	55	275	0.009
T5-280-16	7762-20285	56	280	0.009
T5-295-16	7762-20295	59	295	0.01
T5-300-16	7762-29305	60	300	0.01
T5-305-16	7762-20305	61	305	0.01
T5-320-16	7762-29325	64	320	0.011
T5-325-16	7762-20176	65	325	0.011
T5-330-16	7762-20335	66	330	0.011
T5-340-16	7762-20345	68	340	0.011
T5-350-16	7762-20355	70	350	0.012
T5-355-16	7762-29355	71	355	0.012
T5-365-16	7762-20365	73	365	0.012
T5-375-16	7762-20375	75	375	0.013
T5-390-16	7762-20395	78	390	0.013
T5-400-16	7762-20405	80	400	0.013
T5-410-16	7762-20415	82	410	0.014
T5-420-16	7762-20425	84	420	0.014
T5-425-16	7762-29425	85	425	0.014
T5-430-16	7762-29435	86	430	0.014
T5-440-16	7762-29445	88	440	0.015
T5-445-16	7762-20446	89	445	0.015
T5-450-16	7762-29455	90	450	0.015
T5-455-16	7762-20455	91	455	0.015
T5-460-16	7762-20465	92	460	0.015
T5-475-16	7762-20475	95	475	0.016
T5-480-16	7762-20485	96	480	0.016
T5-500-16	7762-20505	100	500	0.017
T5-510-16	7762-20515	102	510	0.017
T5-525-16	7762-20525	105	525	0.018
T5-545-16	7762-20545	109	545	0.018
T5-550-16	7762-20555	110	550	0.018
T5-560-16	7762-20565	112	560	0.019
T5-575-16	7762-20575	115	575	0.019
T5-590-16	7762-20595	118	590	0.02
T5-600-16	7762-20603	120	600	0.02
T5-610-16	7762-20615	122	610	0.02

Part Number	Product Number	Number of Teeth	Pitch Length (mm)	Weight [kg]
T5-620-16	7762-20625	124	620	0.021
T5-625-16	7762-20775	125	625	0.021
T5-630-16	7762-20635	126	630	0.021
T5-640-16	7762-20645	128	640	0.022
T5-650-16	7762-20655	130	650	0.022
T5-660-16	7762-20665	132	660	0.022
T5-675-16	7762-20675	138	675	0.012
T5-690-16	7762-20695	138	690	0.023
T5-700-16	7762-20705	140	700	0.024
T5-720-16	7762-20725	144	720	0.024
T5-725-16	7762-20734	145	725	0.024
T5-750-16	7762-20755	150	750	0.025
T5-780-16	7762-20785	156	780	0.026
T5-800-16	7762-20803	160	800	0.027
T5-815-16	7762-20815	163	815	0.027
T5-840-16	7762-20845	168	840	0.028
T5-850-16	7762-20854	170	850	0.029
T5-900-16	7762-20905	180	900	0.03
T5-940-16	7762-20945	188	940	0.032
T5-990-16	7762-20995	198	990	0.033
T5-1000-16	7762-21005	200	1000	0.034
T5-1075-16	7762-21075	215	1075	0.036
T5-1100-16	7762-21105	220	1100	0.037
T5-1215-16	7762-21215	243	1215	0.041
T5-1315-16	7762-21315	263	1315	0.044
T5-1350-16	7762-21355	270	1350	0.045
T5-1380-16	7762-21385	276	1380	0.046
T5-1440-16	7762-21445	288	1440	0.048



SYNCHRO-POWER T5-20 BELT

Part Number	Product Number	Number of Teeth	Pitch Length (mm)	Weight [kg]
T5-165-20	7762-20168	33	165	0.007
T5-185-20	7762-20186	37	185	0.008
T5-200-20	7762-20206	40	200	0.008
T5-215-20	7762-29216	43	215	0.009
T5-220-20	7762-20226	44	220	0.009
T5-225-20	7762-29226	45	225	0.009
T5-245-20	7762-20246	49	245	0.01
T5-250-20	7762-20256	50	250	0.011
T5-255-20	7762-29256	51	255	0.011
T5-260-20	7762-20266	52	260	0.011
T5-270-20	7762-20276	54	270	0.011
T5-275-20	7762-29276	55	275	0.012
T5-280-20	7762-20286	56	280	0.012
T5-295-20	7762-20296	59	295	0.012
T5-300-20	7762-29306	60	300	0.013
T5-305-20	7762-20306	61	305	0.013
T5-320-20	7762-29326	64	320	0.013
T5-325-20	7762-20178	65	325	0.014
T5-330-20	7762-20336	66	330	0.014
T5-340-20	7762-20346	68	340	0.014
T5-350-20	7762-20356	70	350	0.015
T5-355-20	7762-29356	71	355	0.015
T5-365-20	7762-20366	73	365	0.015
T5-375-20	7762-20376	75	375	0.016
T5-390-20	7762-20396	78	390	0.016
T5-400-20	7762-20406	80	400	0.017
T5-410-20	7762-20416	82	410	0.017
T5-420-20	7762-20426	84	420	0.018
T5-425-20	7762-29426	85	425	0.018
T5-430-20	7762-20767	86	430	0.018
T5-440-20	7762-29446	88	440	0.018
T5-445-20	7762-20447	89	445	0.019
T5-450-20	7762-29456	90	450	0.019
T5-455-20	7762-20456	91	455	0.019
T5-460-20	7762-20466	92	460	0.019
T5-475-20	7762-20476	95	475	0.02
T5-480-20	7762-20486	96	480	0.02
T5-500-20	7762-20506	100	500	0.021
T5-510-20	7762-20516	102	510	0.021
T5-525-20	7762-20526	105	525	0.022
T5-545-20	7762-20546	109	545	0.023
T5-550-20	7762-20556	110	550	0.023
T5-560-20	7762-20566	112	560	0.024
T5-575-20	7762-20576	115	575	0.024
T5-590-20	7762-20596	118	590	0.025
T5-600-20	7762-20604	120	600	0.025
T5-610-20	7762-20616	122	610	0.026

Part Number	Product Number	Number of Teeth	Pitch Length (mm)	Weight [kg]
T5-620-20	7762-20626	124	620	0.026
T5-625-20	7762-20776	125	625	0.026
T5-630-20	7762-20636	126	630	0.026
T5-640-20	7762-20646	128	640	0.027
T5-650-20	7762-20656	130	650	0.027
T5-660-20	7762-20666	132	660	0.028
T5-675-20	7762-20676	138	675	0.015
T5-690-20	7762-20696	138	690	0.029
T5-700-20	7762-20706	140	700	0.029
T5-720-20	7762-20726	144	720	0.03
T5-725-20	7762-20735	145	725	0.03
T5-750-20	7762-20756	150	750	0.032
T5-780-20	7762-20786	156	780	0.033
T5-800-20	7762-20804	160	800	0.034
T5-815-20	7762-20816	163	815	0.034
T5-840-20	7762-20846	168	840	0.035
T5-850-20	7762-20855	170	850	0.036
T5-900-20	7762-20906	180	900	0.038
T5-940-20	7762-20946	188	940	0.039
T5-990-20	7762-20996	198	990	0.042
T5-1000-20	7762-21006	200	1000	0.042
T5-1075-20	7762-21076	215	1075	0.045
T5-1100-20	7762-21106	220	1100	0.046
T5-1215-20	7762-21216	243	1215	0.051
T5-1315-20	7762-21316	263	1315	0.055
T5-1350-20	7762-21356	270	1350	0.057
T5-1380-20	7762-21386	276	1380	0.058
T5-1440-20	7762-21446	288	1440	0.06

SYNCHRO-POWER T5-25 BELT

Part Number	Product Number	Number of Teeth	Pitch Length (mm)	Weight [kg]
T5-165-25	7762-20169	33	165	0.009
T5-185-25	7762-20187	37	185	0.01
T5-200-25	7762-20207	40	200	0.011
T5-215-25	7762-29217	43	215	0.011
T5-220-25	7762-20227	44	220	0.012
T5-225-25	7762-29227	45	225	0.012
T5-245-25	7762-20247	49	245	0.013
T5-250-25	7762-20257	50	250	0.013
T5-255-25	7762-29257	51	255	0.013
T5-260-25	7762-20267	52	260	0.014
T5-270-25	7762-20277	54	270	0.014
T5-275-25	7762-29277	55	275	0.014
T5-280-25	7762-20287	56	280	0.015
T5-295-25	7762-20297	59	295	0.015
T5-300-25	7762-29307	60	300	0.016
T5-305-25	7762-20307	61	305	0.016
T5-320-25	7762-29327	64	320	0.017
T5-325-25	7762-20179	65	325	0.017
T5-330-25	7762-20337	66	330	0.017
T5-340-25	7762-20347	68	340	0.018
T5-350-25	7762-20357	70	350	0.018
T5-355-25	7762-29357	71	355	0.019
T5-365-25	7762-20367	73	365	0.019
T5-375-25	7762-20377	75	375	0.02
T5-390-25	7762-20397	78	390	0.02
T5-400-25	7762-20407	80	400	0.021
T5-410-25	7762-20417	82	410	0.022
T5-420-25	7762-20427	84	420	0.022
T5-425-25	7762-29427	85	425	0.022
T5-430-25	7762-20768	86	430	0.023
T5-440-25	7762-29447	88	440	0.023
T5-445-25	7762-20448	89	445	0.023
T5-450-25	7762-29457	90	450	0.024
T5-455-25	7762-20457	91	455	0.024
T5-460-25	7762-20467	92	460	0.024
T5-475-25	7762-20477	95	475	0.025
T5-480-25	7762-20487	96	480	0.025
T5-500-25	7762-20507	100	500	0.026
T5-510-25	7762-20517	102	510	0.027
T5-525-25	7762-20527	105	525	0.028
T5-545-25	7762-20547	109	545	0.029
T5-550-25	7762-20557	110	550	0.029
T5-560-25	7762-20567	112	560	0.029
T5-575-25	7762-20577	115	575	0.03
T5-590-25	7762-20597	118	590	0.031
T5-600-25	7762-20605	120	600	0.032
T5-610-25	7762-20617	122	610	0.032

Part Number	Product Number	Number of Teeth	Pitch Length (mm)	Weight [kg]
T5-620-25	7762-20627	124	620	0.033
T5-625-25	7762-20777	125	625	0.033
T5-630-25	7762-20637	126	630	0.033
T5-640-25	7762-20647	128	640	0.034
T5-650-25	7762-20657	130	650	0.034
T5-660-25	7762-20667	132	660	0.035
T5-675-25	7762-20677	138	675	0.018
T5-690-25	7762-20697	138	690	0.036
T5-700-25	7762-20707	140	700	0.037
T5-720-25	7762-20727	144	720	0.038
T5-725-25	7762-20736	145	725	0.038
T5-750-25	7762-20757	150	750	0.039
T5-780-25	7762-20787	156	780	0.041
T5-800-25	7762-20805	160	800	0.042
T5-815-25	7762-20817	163	815	0.043
T5-840-25	7762-20847	168	840	0.044
T5-850-25	7762-20856	170	850	0.045
T5-900-25	7762-20907	180	900	0.047
T5-940-25	7762-20947	188	940	0.049
T5-990-25	7762-20997	198	990	0.052
T5-1000-25	7762-21007	200	1000	0.053
T5-1075-25	7762-21077	215	1075	0.056
T5-1100-25	7762-21107	220	1100	0.058
T5-1215-25	7762-21217	243	1215	0.064
T5-1315-25	7762-21317	263	1315	0.069
T5-1350-25	7762-21357	270	1350	0.071
T5-1380-25	7762-21387	276	1380	0.072
T5-1440-25	7762-21447	288	1440	0.076



SYNCHRO-POWER T5-32 BELT

Part Number	Product Number	Number of Teeth	Pitch Length (mm)	Weight [kg]	Part Number	Product Number	Number of Teeth	Pitch Length (mm)	Weight [kg]
T5-165-32	7762-20170	33	165	0.011	T5-625-32	7762-20778	125	625	0.042
T5-185-32	7762-20188	37	185	0.012	T5-630-32	7762-20638	126	630	0.042
T5-200-32	7762-20208	40	200	0.013	T5-640-32	7762-20648	128	640	0.043
T5-215-32	7762-29218	43	215	0.014	T5-650-32	7762-20658	130	650	0.044
T5-220-32	7762-20228	44	220	0.015	T5-660-32	7762-20668	132	660	0.044
T5-225-32	7762-29228	45	225	0.015	T5-675-32	7762-20678	138	675	0.023
T5-245-32	7762-20248	49	245	0.016	T5-690-32	7762-20698	138	690	0.046
T5-250-32	7762-20258	50	250	0.017	T5-700-32	7762-20708	140	700	0.047
T5-255-32	7762-29258	51	255	0.017	T5-720-32	7762-20728	144	720	0.048
T5-260-32	7762-20268	52	260	0.017	T5-725-32	7762-20737	145	725	0.049
T5-270-32	7762-20278	54	270	0.018	T5-750-32	7762-20758	150	750	0.05
T5-275-32	7762-29278	55	275	0.018	T5-780-32	7762-20788	156	780	0.052
T5-280-32	7762-20288	56	280	0.019	T5-800-32	7762-20806	160	800	0.054
T5-295-32	7762-20298	59	295	0.02	T5-815-32	7762-20818	163	815	0.055
T5-300-32	7762-29308	60	300	0.02	T5-840-32	7762-20848	168	840	0.056
T5-305-32	7762-20308	61	305	0.02	T5-850-32	7762-20857	170	850	0.057
T5-320-32	7762-29328	64	320	0.022	T5-900-32	7762-20908	180	900	0.06
T5-330-32	7762-20338	66	330	0.022	T5-940-32	7762-20948	188	940	0.063
T5-340-32	7762-20348	68	340	0.023	T5-990-32	7762-20998	198	990	0.067
T5-350-32	7762-20358	70	350	0.024	T5-1000-32	7762-21008	200	1000	0.067
T5-355-32	7762-29358	71	355	0.024	T5-1075-32	7762-21078	215	1075	0.072
T5-365-32	7762-20368	73	365	0.025	T5-1100-32	7762-21108	220	1100	0.074
T5-375-32	7762-20378	75	375	0.025	T5-1215-32	7762-21218	243	1215	0.082
T5-390-32	7762-20398	78	390	0.026	T5-1315-32	7762-21318	263	1315	0.088
T5-400-32	7762-20408	80	400	0.027	T5-1350-32	7762-21358	270	1350	0.091
T5-410-32	7762-20418	82	410	0.028	T5-1380-32	7762-21388	276	1380	0.093
T5-420-32	7762-20428	84	420	0.028	T5-1440-32	7762-21448	288	1440	0.097
T5-425-32	7762-29428	85	425	0.029					
T5-430-32	7762-20769	86	430	0.029					
T5-440-32	7762-29448	88	440	0.03					
T5-445-32	7762-20449	89	445	0.03					
T5-450-32	7762-29458	90	450	0.03					
T5-455-32	7762-20458	91	455	0.031					
T5-460-32	7762-20468	92	460	0.031					
T5-475-32	7762-20478	95	475	0.032					
T5-480-32	7762-20488	96	480	0.032					
T5-500-32	7762-20508	100	500	0.034					
T5-510-32	7762-20518	102	510	0.034					
T5-525-32	7762-20528	105	525	0.035					
T5-545-32	7762-20548	109	545	0.037					
T5-550-32	7762-20558	110	550	0.037					
T5-560-32	7762-20568	112	560	0.038					
T5-575-32	7762-20578	115	575	0.039					
T5-590-32	7762-20598	118	590	0.04					
T5-600-32	7762-20606	120	600	0.04					
T5-610-32	7762-20618	122	610	0.041					
T5-620-32	7762-20628	124	620	0.042					

SYNCHRO-POWER T5-50 BELT

Part Number	Product Number	Number of Teeth	Pitch Length (mm)	Weight [kg]
T5-165-50	7762-20171	33	165	0.017
T5-185-50	7762-20189	37	185	0.019
T5-200-50	7762-20209	40	200	0.021
T5-215-50	7762-29219	43	215	0.023
T5-220-50	7762-20229	44	220	0.023
T5-225-50	7762-29229	45	225	0.024
T5-245-50	7762-20249	49	245	0.026
T5-250-50	7762-20259	50	250	0.026
T5-255-50	7762-29259	51	255	0.027
T5-260-50	7762-20269	52	260	0.027
T5-270-50	7762-20279	54	270	0.028
T5-275-50	7762-29279	55	275	0.029
T5-280-50	7762-20289	56	280	0.029
T5-295-50	7762-20299	59	295	0.031
T5-300-50	7762-29309	60	300	0.032
T5-305-50	7762-20309	61	305	0.032
T5-320-50	7762-29312	64	320	0.034
T5-325-50	7762-20237	65	325	0.034
T5-330-50	7762-20339	66	330	0.035
T5-340-50	7762-20349	68	340	0.036
T5-350-50	7762-20359	70	350	0.037
T5-355-50	7762-29359	71	355	0.037
T5-365-50	7762-20369	73	365	0.038
T5-375-50	7762-20379	75	375	0.039
T5-390-50	7762-20399	78	390	0.041
T5-400-50	7762-20409	80	400	0.042
T5-410-50	7762-20419	82	410	0.043
T5-420-50	7762-20429	84	420	0.044
T5-425-50	7762-29429	85	425	0.045
T5-430-50	7762-20770	86	430	0.045
T5-440-50	7762-29449	88	440	0.046
T5-445-50	7762-20450	89	445	0.047
T5-450-50	7762-29459	90	450	0.047
T5-455-50	7762-20459	91	455	0.048
T5-460-50	7762-20469	92	460	0.048
T5-475-50	7762-20479	95	475	0.05
T5-480-50	7762-20489	96	480	0.05
T5-500-50	7762-20509	100	500	0.053
T5-510-50	7762-20519	102	510	0.054
T5-525-50	7762-20529	105	525	0.055
T5-545-50	7762-20549	109	545	0.057
T5-550-50	7762-20559	110	550	0.058
T5-560-50	7762-20569	112	560	0.059
T5-575-50	7762-20579	115	575	0.06
T5-590-50	7762-20599	118	590	0.062
T5-600-50	7762-20607	120	600	0.063
T5-610-50	7762-20619	122	610	0.064

Part Number	Product Number	Number of Teeth	Pitch Length (mm)	Weight [kg]
T5-620-50	7762-20629	124	620	0.065
T5-625-50	7762-20740	125	625	0.066
T5-630-50	7762-20639	126	630	0.066
T5-640-50	7762-20649	128	640	0.067
T5-650-50	7762-20659	130	650	0.068
T5-660-50	7762-20669	132	660	0.069
T5-675-50	7762-20679	138	675	0.037
T5-690-50	7762-20699	138	690	0.072
T5-700-50	7762-20709	140	700	0.074
T5-720-50	7762-20729	144	720	0.076
T5-725-50	7762-20738	145	725	0.076
T5-750-50	7762-20759	150	750	0.079
T5-780-50	7762-20789	156	780	0.082
T5-800-50	7762-20807	160	800	0.084
T5-815-50	7762-20819	163	815	0.086
T5-840-50	7762-20849	168	840	0.088
T5-850-50	7762-20858	170	850	0.089
T5-900-50	7762-20909	180	900	0.095
T5-940-50	7762-20949	188	940	0.099
T5-990-50	7762-20999	198	990	0.104
T5-1000-50	7762-21009	200	1000	0.105
T5-1075-50	7762-21079	215	1075	0.113
T5-1100-50	7762-21109	220	1100	0.116
T5-1215-50	7762-21219	243	1215	0.128
T5-1315-50	7762-21319	263	1315	0.138
T5-1350-50	7762-21359	270	1350	0.142
T5-1380-50	7762-21389	276	1380	0.145
T5-1440-50	7762-21449	288	1440	0.151



SYNCHRO-POWER T5-75 BELT

Part Number	Product Number	Number of Teeth	Pitch Length (mm)	Weight [kg]	Part Number	Product Number	Number of Teeth	Pitch Length (mm)	Weight [kg]
T5-165-75	7762-20172	33	165	0.026	T5-625-75	7762-20742	125	625	0.098
T5-185-75	7762-20190	37	185	0.029	T5-630-75	7762-20640	126	630	0.099
T5-200-75	7762-20210	40	200	0.032	T5-640-75	7762-20650	128	640	0.101
T5-215-75	7762-29220	43	215	0.034	T5-650-75	7762-20660	130	650	0.102
T5-220-75	7762-20230	44	220	0.035	T5-660-75	7762-20670	132	660	0.104
T5-225-75	7762-29230	45	225	0.035	T5-675-75	7762-20680	138	675	0.055
T5-245-75	7762-20250	49	245	0.039	T5-690-75	7762-20700	138	690	0.109
T5-250-75	7762-20260	50	250	0.039	T5-700-75	7762-20710	140	700	0.11
T5-255-75	7762-29260	51	255	0.04	T5-720-75	7762-20730	144	720	0.113
T5-260-75	7762-20270	52	260	0.041	T5-725-75	7762-20739	145	725	0.114
T5-270-75	7762-20280	54	270	0.043	T5-750-75	7762-20760	150	750	0.118
T5-275-75	7762-29280	55	275	0.043	T5-780-75	7762-20790	156	780	0.123
T5-280-75	7762-20290	56	280	0.044	T5-800-75	7762-20808	160	800	0.126
T5-295-75	7762-20300	59	295	0.046	T5-815-75	7762-20820	163	815	0.128
T5-300-75	7762-29310	60	300	0.047	T5-840-75	7762-20850	168	840	0.132
T5-305-75	7762-20310	61	305	0.048	T5-850-75	7762-20859	170	850	0.134
T5-320-75	7762-29313	64	320	0.05	T5-900-75	7762-20910	180	900	0.142
T5-325-75	7762-20238	65	325	0.051	T5-940-75	7762-20950	188	940	0.148
T5-330-75	7762-20340	66	330	0.052	T5-990-75	7762-21000	198	990	0.156
T5-340-75	7762-20350	68	340	0.054	T5-1000-75	7762-21010	200	1000	0.158
T5-355-75	7762-29360	71	355	0.056	T5-1075-75	7762-21080	215	1075	0.169
T5-365-75	7762-20370	73	365	0.057	T5-1100-75	7762-21110	220	1100	0.173
T5-375-75	7762-20380	75	375	0.059	T5-1215-75	7762-21220	243	1215	0.191
T5-390-75	7762-20400	78	390	0.061	T5-1315-75	7762-21320	263	1315	0.207
T5-400-75	7762-20410	80	400	0.063	T5-1350-75	7762-21360	270	1350	0.213
T5-410-75	7762-20420	82	410	0.065	T5-1380-75	7762-21390	276	1380	0.217
T5-420-75	7762-20430	84	420	0.066	T5-1440-75	7762-21450	288	1440	0.227
T5-425-75	7762-29419	85	425	0.067					
T5-430-75	7762-20771	86	430	0.068					
T5-440-75	7762-29440	88	440	0.069					
T5-445-75	7762-20435	89	445	0.07					
T5-450-75	7762-29460	90	450	0.071					
T5-455-75	7762-20460	91	455	0.072					
T5-460-75	7762-20470	92	460	0.072					
T5-475-75	7762-20480	95	475	0.075					
T5-480-75	7762-20490	96	480	0.076					
T5-500-75	7762-20510	100	500	0.079					
T5-510-75	7762-20520	102	510	0.08					
T5-525-75	7762-20530	105	525	0.083					
T5-545-75	7762-20550	109	545	0.086					
T5-550-75	7762-20560	110	550	0.087					
T5-560-75	7762-20570	112	560	0.088					
T5-575-75	7762-20580	115	575	0.091					
T5-590-75	7762-20600	118	590	0.093					
T5-600-75	7762-20608	120	600	0.095					
T5-610-75	7762-20620	122	610	0.096					
T5-620-75	7762-20630	124	620	0.098					

SYNCHRO-POWER T5-SLEEVE

Part Number	Product Number	Number of Teeth	Pitch Length (mm)	Weight [kg]	Sleeve Width [mm]	Cord
T5-165	7761-20165	33	165	0.069	200	Steel
T5-185	7761-20185	37	185	0.078	200	Steel
T5-200	7761-20200	40	200	0.08	200	Steel
T5-215	7761-20215	43	215	0.09	200	Steel
T5-220	7761-20220	44	220	0.093	200	Steel
T5-225	7761-20225	45	225	0.093	200	Steel
T5-245	7761-20245	49	245	0.103	200	Steel
T5-250	7761-20250	50	250	0.105	200	Steel
T5-255	7761-20255	51	255	0.107	200	Steel
T5-260	7761-20260	52	260	0.109	200	Steel
T5-270	7761-20270	54	270	0.113	200	Steel
T5-275	7761-20275	55	275	0.116	200	Steel
T5-280	7761-20280	56	280	0.118	200	Steel
T5-295	7761-20295	59	295	0.124	200	Steel
T5-300	7761-20300	60	300	0.126	200	Steel
T5-305	7761-20305	61	305	0.128	200	Steel
T5-320	7761-20320	64	320	0.134	200	Steel
T5-325	7761-20329	65	325	0.259	380	Steel
T5-330	7761-20339	66	330	0.263	380	Steel
T5-340	7761-20349	68	340	0.271	380	Steel
T5-350	7761-20354	70	350	0.279	380	Steel
T5-355	7761-20359	71	355	0.283	380	Steel
T5-365	7761-20364	73	365	0.287	380	Steel
T5-375	7761-20374	75	375	0.299	380	Steel
T5-390	7761-20389	78	390	0.311	380	Steel
T5-400	7761-20400	80	400	0.319	380	Steel
T5-410	7761-20410	82	410	0.327	380	Steel
T5-420	7761-20420	84	420	0.335	380	Steel
T5-425	7761-20425	85	425	0.339	380	Steel
T5-430	7761-20430	86	430	0.343	380	Steel
T5-440	7761-20440	88	440	0.351	380	Steel
T5-445	7761-20445	89	445	0.355	380	Steel
T5-450	7761-20450	90	450	0.359	380	Steel
T5-455	7761-20455	91	455	0.363	380	Steel
T5-460	7761-20460	92	460	0.367	380	Steel
T5-475	7761-20475	95	475	0.379	380	Steel
T5-480	7761-20480	96	480	0.383	380	Steel
T5-500	7761-20500	100	500	0.399	380	Steel
T5-510	7761-20510	102	510	0.407	380	Steel
T5-525	7761-20525	105	525	0.419	380	Steel
T5-545	7761-20545	109	545	0.435	380	Steel
T5-550	7761-20550	110	550	0.439	380	Steel
T5-560	7761-20560	112	560	0.447	380	Steel
T5-575	7761-20575	115	575	0.459	380	Steel
T5-590	7761-20590	118	590	0.471	380	Steel
T5-600	7761-20600	120	600	0.47	380	Steel

Part Number	Product Number	Number of Teeth	Pitch Length (mm)	Weight [kg]	Sleeve Width [mm]	Cord
T5-610	7761-20610	122	610	0.487	380	Steel
T5-620	7761-20620	124	620	0.495	380	Steel
T5-625	7761-20625	125	625	0.499	380	Steel
T5-630	7761-20630	126	630	0.503	380	Steel
T5-640	7761-20640	128	640	0.511	380	Steel
T5-650	7761-20650	130	650	0.519	380	Steel
T5-660	7761-20660	132	660	0.527	380	Steel
T5-675	7761-20675	135	675	0.279	380	Steel
T5-690	7761-20690	138	690	0.551	380	Steel
T5-700	7761-20700	140	700	0.559	380	Steel
T5-720	7761-20720	144	720	0.575	380	Steel
T5-725	7761-20725	145	725	0.579	380	Steel
T5-750	7761-20750	150	750	0.599	380	Steel
T5-780	7761-20780	156	780	0.622	380	Steel
T5-800	7761-20800	160	800	0.638	380	Steel
T5-815	7761-20815	163	815	0.65	380	Steel
T5-840	7761-20840	168	840	0.67	380	Steel
T5-850	7761-20850	170	850	0.678	380	Steel
T5-900	7761-20900	180	900	0.718	380	Steel
T5-940	7761-20940	188	940	0.75	380	Steel
T5-990	7761-20990	198	990	0.79	380	Steel
T5-1000	7761-21000	200	1000	0.798	380	Steel
T5-1075	7761-21075	215	1075	0.858	380	Steel
T5-1100	7761-21100	220	1100	0.878	380	Steel
T5-1215	7761-21215	243	1215	0.97	380	Steel
T5-1315	7761-21315	263	1315	1.049	380	Steel
T5-1350	7761-21350	270	1350	1.077	380	Steel
T5-1380	7761-21380	276	1380	1.101	380	Steel
T5-1440	7761-21440	288	1440	1.149	380	Steel

SYNCHRO-POWER T5-SLEEVE

Part Number	Product Number	Number of Teeth	Pitch Length (mm)	Weight [kg]	Sleeve Width [mm]	Cord
T5-165-AR	7761-20162	33	165	0.069	200	Aramid
T5-185-AR	7761-20182	37	185	0.078	200	Aramid
T5-200-AR	7761-20202	40	200	0.084	200	Aramid
T5-215-AR	7761-20212	43	215	0.09	200	Aramid
T5-220-AR	7761-20221	44	220	0.092	200	Aramid
T5-225-AR	7761-20222	45	225	0.095	200	Aramid
T5-245-AR	7761-20242	49	245	0.103	200	Aramid
T5-250-AR	7761-20251	50	250	0.105	200	Aramid
T5-255-AR	7761-20252	51	255	0.107	200	Aramid
T5-260-AR	7761-20262	52	260	0.109	200	Aramid
T5-270-AR	7761-20271	54	270	0.113	200	Aramid
T5-275-AR	7761-20272	55	275	0.116	200	Aramid
T5-280-AR	7761-20282	56	280	0.118	200	Aramid
T5-295-AR	7761-20292	59	295	0.124	200	Aramid
T5-300-AR	7761-20301	60	300	0.126	200	Aramid
T5-305-AR	7761-20302	61	305	0.128	200	Aramid
T5-320-AR	7761-20321	64	320	0.134	200	Aramid
T5-325-AR	7761-20322	65	325	0.259	380	Aramid
T5-330-AR	7761-20332	66	330	0.263	380	Aramid
T5-340-AR	7761-20342	68	340	0.271	380	Aramid
T5-350-AR	7761-20351	70	350	0.279	380	Aramid
T5-355-AR	7761-20352	71	355	0.283	380	Aramid
T5-365-AR	7761-20362	73	365	0.291	380	Aramid
T5-375-AR	7761-20372	75	375	0.299	380	Aramid
T5-390-AR	7761-20382	78	390	0.311	380	Aramid
T5-400-AR	7761-20402	80	400	0.319	380	Aramid
T5-410-AR	7761-20412	82	410	0.327	380	Aramid
T5-420-AR	7761-20421	84	420	0.335	380	Aramid
T5-425-AR	7761-20422	85	425	0.339	380	Aramid
T5-430-AR	7761-20432	86	430	0.343	380	Aramid
T5-440-AR	7761-20441	88	440	0.351	380	Aramid
T5-445-AR	7761-20442	89	445	0.355	380	Aramid
T5-450-AR	7761-20451	90	450	0.359	380	Aramid
T5-455-AR	7761-20452	91	455	0.363	380	Aramid
T5-460-AR	7761-20462	92	460	0.367	380	Aramid
T5-475-AR	7761-20472	95	475	0.379	380	Aramid
T5-480-AR	7761-20482	96	480	0.383	380	Aramid
T5-500-AR	7761-20502	100	500	0.399	380	Aramid
T5-510-AR	7761-20512	102	510	0.407	380	Aramid
T5-525-AR	7761-20522	105	525	0.419	380	Aramid
T5-545-AR	7761-20542	109	545	0.435	380	Aramid
T5-550-AR	7761-20552	110	550	0.439	380	Aramid
T5-560-AR	7761-20562	112	560	0.447	380	Aramid
T5-575-AR	7761-20572	115	575	0.459	380	Aramid
T5-590-AR	7761-20592	118	590	0.471	380	Aramid
T5-600-AR	7761-20602	120	600	0.479	380	Aramid

Part Number	Product Number	Number of Teeth	Pitch Length (mm)	Weight [kg]	Sleeve Width [mm]	Cord
T5-610-AR	7761-20612	122	610	0.487	380	Aramid
T5-620-AR	7761-20621	124	620	0.495	380	Aramid
T5-625-AR	7761-20622	125	625	0.499	380	Aramid
T5-630-AR	7761-20632	126	630	0.503	380	Aramid
T5-640-AR	7761-20642	128	640	0.511	380	Aramid
T5-650-AR	7761-20652	130	650	0.519	380	Aramid
T5-660-AR	7761-20662	132	660	0.527	380	Aramid
T5-675-AR	7761-20672	135	675	0.539	380	Aramid
T5-690-AR	7761-20692	138	690	0.551	380	Aramid
T5-700-AR	7761-20702	140	700	0.559	380	Aramid
T5-720-AR	7761-20721	144	720	0.575	380	Aramid
T5-725-AR	7761-20722	145	725	0.579	380	Aramid
T5-750-AR	7761-20752	150	750	0.599	380	Aramid
T5-780-AR	7761-20782	156	780	0.622	380	Aramid
T5-800-AR	7761-20802	160	800	0.638	380	Aramid
T5-815-AR	7761-20812	163	815	0.65	380	Aramid
T5-840-AR	7761-20842	168	840	0.67	380	Aramid
T5-850-AR	7761-20852	170	850	0.678	380	Aramid
T5-900-AR	7761-20902	180	900	0.718	380	Aramid
T5-940-AR	7761-20942	188	940	0.75	380	Aramid
T5-990-AR	7761-20992	198	990	0.79	380	Aramid
T5-1000-AR	7761-21002	200	1000	0.798	380	Aramid
T5-1075-AR	7761-21072	215	1075	0.858	380	Aramid
T5-1100-AR	7761-21102	220	1100	0.878	380	Aramid
T5-1215-AR	7761-21212	243	1215	0.97	380	Aramid
T5-1315-AR	7761-21312	263	1315	1.049	380	Aramid
T5-1350-AR	7761-21352	270	1350	1.077	380	Aramid
T5-1380-AR	7761-21382	276	1380	1.101	380	Aramid
T5-1440-AR	7761-21442	288	1440	1.149	380	Aramid



SYNCHRO-POWER T10-10 BELT

Part Number	Product Number	Number of Teeth	Pitch Length (mm)	Weight [kg]
T10-260-10	7762-30261	26	260	0.011
T10-320-10	7762-30321	32	320	0.014
T10-370-10	7762-30371	37	370	0.016
T10-400-10	7762-30401	40	400	0.018
T10-410-10	7762-30411	41	410	0.018
T10-440-10	7762-30441	44	440	0.019
T10-450-10	7762-30451	45	450	0.02
T10-500-10	7762-30501	50	500	0.022
T10-530-10	7762-30531	53	530	0.023
T10-550-10	7762-30551	55	550	0.024
T10-560-10	7762-30561	56	560	0.025
T10-600-10	7762-30601	60	600	0.026
T10-610-10	7762-30611	61	610	0.027
T10-630-10	7762-30631	63	630	0.028
T10-650-10	7762-30651	65	650	0.029
T10-660-10	7762-30661	66	660	0.029
T10-690-10	7762-30691	69	690	0.03
T10-700-10	7762-30701	70	700	0.031
T10-720-10	7762-30721	72	720	0.032
T10-750-10	7762-30751	75	750	0.033
T10-780-10	7762-30781	78	780	0.034
T10-800-10	7762-30801	80	800	0.035
T10-810-10	7762-30811	81	810	0.036
T10-840-10	7762-30841	84	840	0.037
T10-850-10	7762-30851	85	850	0.037
T10-880-10	7762-30881	88	880	0.039
T10-890-10	7762-30891	89	890	0.039
T10-900-10	7762-30901	90	900	0.04
T10-910-10	7762-30911	91	910	0.04
T10-920-10	7762-30921	92	920	0.04
T10-950-10	7762-30951	95	950	0.042
T10-960-10	7762-30961	96	960	0.042
T10-970-10	7762-30971	97	970	0.043
T10-980-10	7762-30981	98	980	0.043
T10-1000-10	7762-31001	100	1000	0.044
T10-1010-10	7762-31011	101	1010	0.044
T10-1050-10	7762-31051	105	1050	0.046
T10-1080-10	7762-31081	108	1080	0.048
T10-1100-10	7762-31101	110	1100	0.048
T10-1110-10	7762-31111	111	1110	0.049
T10-1140-10	7762-31141	114	1140	0.05
T10-1150-10	7762-31151	115	1150	0.051
T10-1200-10	7762-31201	120	1200	0.053
T10-1210-10	7762-31211	121	1210	0.053
T10-1240-10	7762-31241	124	1240	0.055
T10-1250-10	7762-31251	125	1250	0.055
T10-1300-10	7762-31301	130	1300	0.057

Part Number	Product Number	Number of Teeth	Pitch Length (mm)	Weight [kg]
T10-1320-10	7762-31321	132	1320	0.058
T10-1350-10	7762-31351	135	1350	0.059
T10-1390-10	7762-31391	139	1390	0.061
T10-1400-10	7762-31401	140	1400	0.062
T10-1420-10	7762-31421	142	1420	0.062
T10-1440-10	7762-31441	144	1440	0.063
T10-1450-10	7762-31451	145	1450	0.064
T10-1460-10	7762-31461	146	1460	0.064
T10-1500-10	7762-31501	150	1500	0.066
T10-1560-10	7762-31561	156	1560	0.069
T10-1600-10	7762-31601	160	1600	0.07
T10-1610-10	7762-31611	161	1610	0.071
T10-1700-10	7762-31701	170	1700	0.075
T10-1750-10	7762-31751	175	1750	0.077
T10-1780-10	7762-31781	178	1780	0.078
T10-1800-10	7762-31801	180	1800	0.079
T10-1880-10	7762-31881	188	1880	0.083
T10-1960-10	7762-31961	196	1960	0.086
T10-2250-10	7762-32251	225	2250	0.099



SYNCHRO-POWER T10-12 BELT

Part Number	Product Number	Number of Teeth	Pitch Length (mm)	Weight [kg]
T10-260-12	7762-30262	26	260	0.014
T10-320-12	7762-30322	32	320	0.017
T10-370-12	7762-30372	37	370	0.02
T10-400-12	7762-30402	40	400	0.021
T10-410-12	7762-30412	41	410	0.022
T10-440-12	7762-30442	44	440	0.023
T10-450-12	7762-30452	45	450	0.024
T10-500-12	7762-30502	50	500	0.026
T10-530-12	7762-30532	53	530	0.028
T10-550-12	7762-30552	55	550	0.029
T10-560-12	7762-30562	56	560	0.03
T10-600-12	7762-30602	60	600	0.032
T10-610-12	7762-30612	61	610	0.032
T10-630-12	7762-30632	63	630	0.033
T10-650-12	7762-30652	65	650	0.034
T10-660-12	7762-30662	66	660	0.035
T10-690-12	7762-30692	69	690	0.036
T10-700-12	7762-30702	70	700	0.037
T10-720-12	7762-30722	72	720	0.038
T10-750-12	7762-30752	75	750	0.04
T10-780-12	7762-30782	78	780	0.041
T10-800-12	7762-30800	80	800	0.042
T10-810-12	7762-30812	81	810	0.043
T10-840-12	7762-30842	84	840	0.044
T10-850-12	7762-30850	85	850	0.045
T10-880-12	7762-30882	88	880	0.046
T10-890-12	7762-30892	89	890	0.047
T10-900-12	7762-30902	90	900	0.048
T10-910-12	7762-30912	91	910	0.048
T10-920-12	7762-30922	92	920	0.049
T10-950-12	7762-30950	95	950	0.05
T10-960-12	7762-30962	96	960	0.051
T10-970-12	7762-30972	97	970	0.051
T10-980-12	7762-30982	98	980	0.052
T10-1000-12	7762-31008	100	1000	0.053
T10-1010-12	7762-31012	101	1010	0.053
T10-1050-12	7762-31052	105	1050	0.055
T10-1080-12	7762-31082	108	1080	0.057
T10-1100-12	7762-31108	110	1100	0.058
T10-1110-12	7762-31112	111	1110	0.059
T10-1140-12	7762-31142	114	1140	0.06
T10-1150-12	7762-31152	115	1150	0.061
T10-1200-12	7762-31202	120	1200	0.063
T10-1210-12	7762-31212	121	1210	0.064
T10-1240-12	7762-31242	124	1240	0.065
T10-1250-12	7762-31252	125	1250	0.066
T10-1300-12	7762-31302	130	1300	0.069

Part Number	Product Number	Number of Teeth	Pitch Length (mm)	Weight [kg]
T10-1320-12	7762-31322	132	1320	0.07
T10-1350-12	7762-31352	135	1350	0.071
T10-1390-12	7762-31392	139	1390	0.073
T10-1400-12	7762-31402	140	1400	0.074
T10-1420-12	7762-31422	142	1420	0.075
T10-1440-12	7762-31442	144	1440	0.076
T10-1450-12	7762-31452	145	1450	0.077
T10-1460-12	7762-31462	146	1460	0.077
T10-1500-12	7762-31502	150	1500	0.079
T10-1560-12	7762-31562	156	1560	0.082
T10-1600-12	7762-31608	160	1600	0.084
T10-1610-12	7762-31612	161	1610	0.085
T10-1700-12	7762-31708	170	1700	0.09
T10-1750-12	7762-31752	175	1750	0.092
T10-1780-12	7762-31782	178	1780	0.094
T10-1800-12	7762-31802	180	1800	0.095
T10-1880-12	7762-31882	188	1880	0.099
T10-1960-12	7762-31962	196	1960	0.103
T10-2250-12	7762-32252	225	2250	0.119

SYNCHRO-POWER T10-16 BELT

Part Number	Product Number	Number of Teeth	Pitch Length (mm)	Weight [kg]
T10-260-16	7762-30263	26	260	0.018
T10-320-16	7762-30323	32	320	0.023
T10-370-16	7762-30373	37	370	0.026
T10-400-16	7762-30403	40	400	0.028
T10-410-16	7762-30413	41	410	0.029
T10-440-16	7762-30443	44	440	0.031
T10-450-16	7762-30453	45	450	0.032
T10-500-16	7762-30503	50	500	0.035
T10-530-16	7762-30533	53	530	0.037
T10-550-16	7762-30553	55	550	0.039
T10-560-16	7762-30563	56	560	0.039
T10-600-16	7762-30603	60	600	0.042
T10-610-16	7762-30613	61	610	0.043
T10-630-16	7762-30633	63	630	0.044
T10-650-16	7762-30653	65	650	0.046
T10-660-16	7762-30663	66	660	0.046
T10-690-16	7762-30693	69	690	0.049
T10-700-16	7762-30703	70	700	0.049
T10-720-16	7762-30723	72	720	0.051
T10-750-16	7762-30753	75	750	0.053
T10-780-16	7762-30783	78	780	0.055
T10-800-16	7762-30802	80	800	0.056
T10-810-16	7762-30813	81	810	0.057
T10-840-16	7762-30843	84	840	0.059
T10-850-16	7762-30852	85	850	0.06
T10-880-16	7762-30883	88	880	0.062
T10-890-16	7762-30893	89	890	0.063
T10-900-16	7762-30903	90	900	0.063
T10-910-16	7762-30913	91	910	0.064
T10-920-16	7762-30923	92	920	0.065
T10-950-16	7762-30952	95	950	0.067
T10-960-16	7762-30963	96	960	0.068
T10-970-16	7762-30973	97	970	0.068
T10-980-16	7762-30983	98	980	0.069
T10-1000-16	7762-31002	100	1000	0.07
T10-1010-16	7762-31013	101	1010	0.071
T10-1050-16	7762-31053	105	1050	0.074
T10-1080-16	7762-31083	108	1080	0.076
T10-1100-16	7762-31102	110	1100	0.077
T10-1110-16	7762-31113	111	1110	0.078
T10-1140-16	7762-31143	114	1140	0.08
T10-1150-16	7762-31153	115	1150	0.081
T10-1200-16	7762-31203	120	1200	0.084
T10-1210-16	7762-31213	121	1210	0.085
T10-1240-16	7762-31243	124	1240	0.087
T10-1250-16	7762-31253	125	1250	0.088
T10-1300-16	7762-31303	130	1300	0.092

Part Number	Product Number	Number of Teeth	Pitch Length (mm)	Weight [kg]
T10-1320-16	7762-31323	132	1320	0.093
T10-1350-16	7762-31353	135	1350	0.095
T10-1390-16	7762-31393	139	1390	0.098
T10-1400-16	7762-31403	140	1400	0.099
T10-1420-16	7762-31423	142	1420	0.1
T10-1440-16	7762-31443	144	1440	0.101
T10-1450-16	7762-31453	145	1450	0.102
T10-1460-16	7762-31463	146	1460	0.103
T10-1500-16	7762-31503	150	1500	0.106
T10-1560-16	7762-31563	156	1560	0.11
T10-1600-16	7762-31602	160	1600	0.113
T10-1610-16	7762-31613	161	1610	0.113
T10-1700-16	7762-31702	170	1700	0.12
T10-1750-16	7762-31753	175	1750	0.123
T10-1780-16	7762-31783	178	1780	0.125
T10-1800-16	7762-31803	180	1800	0.127
T10-1880-16	7762-31883	188	1880	0.132
T10-1960-16	7762-31963	196	1960	0.138
T10-2250-16	7762-32253	225	2250	0.158



SYNCHRO-POWER T10-20 BELT

Part Number	Product Number	Number of Teeth	Pitch Length (mm)	Weight [kg]
T10-260-20	7762-30264	26	260	0.023
T10-320-20	7762-30324	32	320	0.028
T10-370-20	7762-30374	37	370	0.033
T10-400-20	7762-30404	40	400	0.035
T10-410-20	7762-30414	41	410	0.036
T10-440-20	7762-30444	44	440	0.039
T10-450-20	7762-30454	45	450	0.04
T10-500-20	7762-30504	50	500	0.044
T10-530-20	7762-30534	53	530	0.047
T10-550-20	7762-30554	55	550	0.048
T10-560-20	7762-30564	56	560	0.049
T10-600-20	7762-30604	60	600	0.053
T10-610-20	7762-30614	61	610	0.054
T10-630-20	7762-30634	63	630	0.055
T10-650-20	7762-30654	65	650	0.057
T10-660-20	7762-30664	66	660	0.058
T10-690-20	7762-30694	69	690	0.061
T10-700-20	7762-30704	70	700	0.062
T10-720-20	7762-30724	72	720	0.063
T10-750-20	7762-30754	75	750	0.066
T10-780-20	7762-30784	78	780	0.069
T10-800-20	7762-30803	80	800	0.07
T10-810-20	7762-30814	81	810	0.071
T10-840-20	7762-30844	84	840	0.074
T10-850-20	7762-30853	85	850	0.075
T10-880-20	7762-30884	88	880	0.077
T10-890-20	7762-30894	89	890	0.078
T10-900-20	7762-30904	90	900	0.079
T10-910-20	7762-30914	91	910	0.08
T10-920-20	7762-30924	92	920	0.081
T10-950-20	7762-30953	95	950	0.084
T10-960-20	7762-30964	96	960	0.084
T10-970-20	7762-30974	97	970	0.085
T10-980-20	7762-30984	98	980	0.086
T10-1000-20	7762-31003	100	1000	0.088
T10-1010-20	7762-31014	101	1010	0.089
T10-1050-20	7762-31054	105	1050	0.092
T10-1080-20	7762-31084	108	1080	0.095
T10-1100-20	7762-31103	110	1100	0.097
T10-1110-20	7762-31114	111	1110	0.098
T10-1140-20	7762-31144	114	1140	0.1
T10-1150-20	7762-31154	115	1150	0.101
T10-1200-20	7762-31204	120	1200	0.106
T10-1210-20	7762-31214	121	1210	0.106
T10-1240-20	7762-31244	124	1240	0.109
T10-1250-20	7762-31254	125	1250	0.11
T10-1300-20	7762-31304	130	1300	0.114

Part Number	Product Number	Number of Teeth	Pitch Length (mm)	Weight [kg]
T10-1320-20	7762-31324	132	1320	0.116
T10-1350-20	7762-31354	135	1350	0.119
T10-1390-20	7762-31394	139	1390	0.122
T10-1400-20	7762-31404	140	1400	0.123
T10-1420-20	7762-31424	142	1420	0.125
T10-1440-20	7762-31444	144	1440	0.127
T10-1450-20	7762-31454	145	1450	0.128
T10-1460-20	7762-31464	146	1460	0.128
T10-1500-20	7762-31504	150	1500	0.132
T10-1560-20	7762-31564	156	1560	0.137
T10-1600-20	7762-31603	160	1600	0.141
T10-1610-20	7762-31614	161	1610	0.142
T10-1700-20	7762-31703	170	1700	0.15
T10-1750-20	7762-31754	175	1750	0.154
T10-1780-20	7762-31784	178	1780	0.157
T10-1800-20	7762-31804	180	1800	0.158
T10-1880-20	7762-31884	188	1880	0.165
T10-1960-20	7762-31964	196	1960	0.172
T10-2250-20	7762-32254	225	2250	0.198



SYNCHRO-POWER T10-25 BELT

Part Number	Product Number	Number of Teeth	Pitch Length (mm)	Weight [kg]
T10-260-25	7762-30265	26	260	0.029
T10-320-25	7762-30325	32	320	0.035
T10-370-25	7762-30375	37	370	0.041
T10-400-25	7762-30405	40	400	0.044
T10-410-25	7762-30415	41	410	0.045
T10-440-25	7762-30445	44	440	0.048
T10-450-25	7762-30455	45	450	0.05
T10-500-25	7762-30505	50	500	0.055
T10-530-25	7762-30535	53	530	0.058
T10-550-25	7762-30555	55	550	0.061
T10-560-25	7762-30565	56	560	0.062
T10-600-25	7762-30605	60	600	0.066
T10-610-25	7762-30615	61	610	0.067
T10-630-25	7762-30635	63	630	0.069
T10-650-25	7762-30655	65	650	0.072
T10-660-25	7762-30665	66	660	0.073
T10-690-25	7762-30695	69	690	0.076
T10-700-25	7762-30705	70	700	0.077
T10-720-25	7762-30725	72	720	0.079
T10-750-25	7762-30755	75	750	0.083
T10-780-25	7762-30785	78	780	0.086
T10-800-25	7762-30804	80	800	0.088
T10-810-25	7762-30815	81	810	0.089
T10-840-25	7762-30845	84	840	0.092
T10-850-25	7762-30854	85	850	0.094
T10-880-25	7762-30885	88	880	0.097
T10-890-25	7762-30895	89	890	0.098
T10-900-25	7762-30905	90	900	0.099
T10-910-25	7762-30915	91	910	0.1
T10-920-25	7762-30925	92	920	0.101
T10-950-25	7762-30954	95	950	0.105
T10-960-25	7762-30965	96	960	0.106
T10-970-25	7762-30975	97	970	0.107
T10-980-25	7762-30985	98	980	0.108
T10-1000-25	7762-31004	100	1000	0.11
T10-1010-25	7762-31015	101	1010	0.111
T10-1050-25	7762-31055	105	1050	0.116
T10-1080-25	7762-31085	108	1080	0.119
T10-1100-25	7762-31104	110	1100	0.121
T10-1110-25	7762-31115	111	1110	0.122
T10-1140-25	7762-31145	114	1140	0.125
T10-1150-25	7762-31155	115	1150	0.127
T10-1200-25	7762-31205	120	1200	0.132
T10-1210-25	7762-31215	121	1210	0.133
T10-1240-25	7762-31245	124	1240	0.136
T10-1250-25	7762-31255	125	1250	0.138
T10-1300-25	7762-31305	130	1300	0.143

Part Number	Product Number	Number of Teeth	Pitch Length (mm)	Weight [kg]
T10-1320-25	7762-31325	132	1320	0.145
T10-1350-25	7762-31355	135	1350	0.149
T10-1390-25	7762-31395	139	1390	0.153
T10-1400-25	7762-31405	140	1400	0.154
T10-1420-25	7762-31425	142	1420	0.156
T10-1440-25	7762-31445	144	1440	0.158
T10-1450-25	7762-31455	145	1450	0.16
T10-1460-25	7762-31465	146	1460	0.161
T10-1500-25	7762-31505	150	1500	0.165
T10-1560-25	7762-31565	156	1560	0.172
T10-1600-25	7762-31604	160	1600	0.176
T10-1610-25	7762-31615	161	1610	0.177
T10-1700-25	7762-31704	170	1700	0.187
T10-1750-25	7762-31755	175	1750	0.193
T10-1780-25	7762-31785	178	1780	0.196
T10-1800-25	7762-31805	180	1800	0.198
T10-1880-25	7762-31885	188	1880	0.207
T10-1960-25	7762-31965	196	1960	0.216
T10-2250-25	7762-32255	225	2250	0.248



SYNCHRO-POWER T10-32 BELT

Part Number	Product Number	Number of Teeth	Pitch Length (mm)	Weight [kg]
T10-260-32	7762-30266	26	260	0.037
T10-320-32	7762-30326	32	320	0.045
T10-370-32	7762-30376	37	370	0.052
T10-400-32	7762-30406	40	400	0.056
T10-410-32	7762-30416	41	410	0.058
T10-440-32	7762-30446	44	440	0.062
T10-450-32	7762-30456	45	450	0.063
T10-500-32	7762-30506	50	500	0.07
T10-530-32	7762-30536	53	530	0.075
T10-550-32	7762-30556	55	550	0.077
T10-560-32	7762-30566	56	560	0.079
T10-600-32	7762-30606	60	600	0.084
T10-610-32	7762-30616	61	610	0.086
T10-630-32	7762-30636	63	630	0.089
T10-650-32	7762-30656	65	650	0.092
T10-660-32	7762-30666	66	660	0.093
T10-690-32	7762-30696	69	690	0.097
T10-700-32	7762-30706	70	700	0.099
T10-720-32	7762-30726	72	720	0.101
T10-750-32	7762-30756	75	750	0.106
T10-780-32	7762-30786	78	780	0.11
T10-800-32	7762-30805	80	800	0.113
T10-810-32	7762-30816	81	810	0.114
T10-840-32	7762-30846	84	840	0.118
T10-850-32	7762-30855	85	850	0.12
T10-880-32	7762-30886	88	880	0.124
T10-890-32	7762-30896	89	890	0.125
T10-900-32	7762-30906	90	900	0.127
T10-910-32	7762-30916	91	910	0.128
T10-920-32	7762-30926	92	920	0.13
T10-950-32	7762-30955	95	950	0.134
T10-960-32	7762-30966	96	960	0.135
T10-970-32	7762-30976	97	970	0.137
T10-980-32	7762-30986	98	980	0.138
T10-1000-32	7762-31005	100	1000	0.141
T10-1010-32	7762-31016	101	1010	0.142
T10-1050-32	7762-31056	105	1050	0.148
T10-1080-32	7762-31086	108	1080	0.152
T10-1100-32	7762-31105	110	1100	0.155
T10-1110-32	7762-31116	111	1110	0.156
T10-1140-32	7762-31146	114	1140	0.161
T10-1150-32	7762-31156	115	1150	0.162
T10-1200-32	7762-31206	120	1200	0.169
T10-1210-32	7762-31216	121	1210	0.17
T10-1240-32	7762-31246	124	1240	0.175
T10-1250-32	7762-31256	125	1250	0.176
T10-1300-32	7762-31306	130	1300	0.183

Part Number	Product Number	Number of Teeth	Pitch Length (mm)	Weight [kg]
T10-1320-32	7762-31326	132	1320	0.186
T10-1350-32	7762-31356	135	1350	0.19
T10-1390-32	7762-31396	139	1390	0.196
T10-1400-32	7762-31406	140	1400	0.197
T10-1420-32	7762-31426	142	1420	0.2
T10-1440-32	7762-31446	144	1440	0.203
T10-1450-32	7762-31456	145	1450	0.204
T10-1460-32	7762-31466	146	1460	0.206
T10-1500-32	7762-31506	150	1500	0.211
T10-1560-32	7762-31566	156	1560	0.22
T10-1600-32	7762-31605	160	1600	0.225
T10-1610-32	7762-31616	161	1610	0.227
T10-1700-32	7762-31705	170	1700	0.239
T10-1750-32	7762-31756	175	1750	0.246
T10-1780-32	7762-31786	178	1780	0.251
T10-1800-32	7762-31806	180	1800	0.253
T10-1880-32	7762-31886	188	1880	0.265
T10-1960-32	7762-31966	196	1960	0.276
T10-2250-32	7762-32256	225	2250	0.317

SYNCHRO-POWER T10-50 BELT

Part Number	Product Number	Number of Teeth	Pitch Length (mm)	Weight [kg]
T10-260-50	7762-30267	26	260	0.057
T10-320-50	7762-30327	32	320	0.07
T10-370-50	7762-30377	37	370	0.081
T10-400-50	7762-30407	40	400	0.088
T10-410-50	7762-30417	41	410	0.09
T10-440-50	7762-30447	44	440	0.097
T10-450-50	7762-30457	45	450	0.099
T10-500-50	7762-30507	50	500	0.11
T10-530-50	7762-30537	53	530	0.117
T10-550-50	7762-30557	55	550	0.121
T10-560-50	7762-30567	56	560	0.123
T10-600-50	7762-30607	60	600	0.132
T10-610-50	7762-30617	61	610	0.134
T10-630-50	7762-30637	63	630	0.139
T10-650-50	7762-30657	65	650	0.143
T10-660-50	7762-30667	66	660	0.145
T10-690-50	7762-30697	69	690	0.152
T10-700-50	7762-30707	70	700	0.154
T10-720-50	7762-30727	72	720	0.158
T10-750-50	7762-30757	75	750	0.165
T10-780-50	7762-30787	78	780	0.172
T10-800-50	7762-30806	80	800	0.176
T10-810-50	7762-30817	81	810	0.178
T10-840-50	7762-30847	84	840	0.185
T10-850-50	7762-30856	85	850	0.187
T10-880-50	7762-30887	88	880	0.194
T10-890-50	7762-30897	89	890	0.196
T10-900-50	7762-30907	90	900	0.198
T10-910-50	7762-30917	91	910	0.2
T10-920-50	7762-30927	92	920	0.202
T10-950-50	7762-30956	95	950	0.209
T10-960-50	7762-30967	96	960	0.211
T10-970-50	7762-30977	97	970	0.213
T10-980-50	7762-30987	98	980	0.216
T10-1000-50	7762-31006	100	1000	0.22
T10-1010-50	7762-31017	101	1010	0.222
T10-1050-50	7762-31057	105	1050	0.231
T10-1080-50	7762-31087	108	1080	0.238
T10-1100-50	7762-31106	110	1100	0.242
T10-1110-50	7762-31117	111	1110	0.244
T10-1140-50	7762-31147	114	1140	0.251
T10-1150-50	7762-31157	115	1150	0.253
T10-1200-50	7762-31207	120	1200	0.264
T10-1210-50	7762-31217	121	1210	0.266
T10-1240-50	7762-31247	124	1240	0.273
T10-1250-50	7762-31257	125	1250	0.275
T10-1300-50	7762-31307	130	1300	0.286

Part Number	Product Number	Number of Teeth	Pitch Length (mm)	Weight [kg]
T10-1320-50	7762-31327	132	1320	0.29
T10-1350-50	7762-31357	135	1350	0.297
T10-1390-50	7762-31397	139	1390	0.306
T10-1400-50	7762-31407	140	1400	0.308
T10-1420-50	7762-31427	142	1420	0.312
T10-1440-50	7762-31447	144	1440	0.317
T10-1450-50	7762-31457	145	1450	0.319
T10-1460-50	7762-31467	146	1460	0.321
T10-1500-50	7762-31507	150	1500	0.33
T10-1560-50	7762-31567	156	1560	0.343
T10-1600-50	7762-31606	160	1600	0.352
T10-1610-50	7762-31617	161	1610	0.354
T10-1700-50	7762-31706	170	1700	0.374
T10-1750-50	7762-31757	175	1750	0.385
T10-1780-50	7762-31787	178	1780	0.392
T10-1800-50	7762-31807	180	1800	0.396
T10-1880-50	7762-31887	188	1880	0.414
T10-1960-50	7762-31967	196	1960	0.431
T10-2250-50	7762-32257	225	2250	0.495



SYNCHRO-POWER T10-75 BELT

Part Number	Product Number	Number of Teeth	Pitch Length (mm)	Weight [kg]
T10-260-75	7762-30268	26	260	0.086
T10-320-75	7762-30328	32	320	0.106
T10-370-75	7762-30378	37	370	0.122
T10-400-75	7762-30408	40	400	0.132
T10-410-75	7762-30418	41	410	0.135
T10-440-75	7762-30448	44	440	0.145
T10-450-75	7762-30458	45	450	0.149
T10-500-75	7762-30508	50	500	0.165
T10-530-75	7762-30538	53	530	0.175
T10-550-75	7762-30558	55	550	0.182
T10-560-75	7762-30568	56	560	0.185
T10-600-75	7762-30608	60	600	0.198
T10-610-75	7762-30618	61	610	0.201
T10-630-75	7762-30638	63	630	0.208
T10-650-75	7762-30658	65	650	0.215
T10-660-75	7762-30668	66	660	0.218
T10-690-75	7762-30698	69	690	0.228
T10-700-75	7762-30708	70	700	0.231
T10-720-75	7762-30728	72	720	0.238
T10-750-75	7762-30758	75	750	0.248
T10-780-75	7762-30788	78	780	0.257
T10-800-75	7762-30807	80	800	0.264
T10-810-75	7762-30818	81	810	0.267
T10-840-75	7762-30848	84	840	0.277
T10-850-75	7762-30857	85	850	0.281
T10-880-75	7762-30888	88	880	0.29
T10-890-75	7762-30898	89	890	0.294
T10-900-75	7762-30908	90	900	0.297
T10-910-75	7762-30918	91	910	0.3
T10-920-75	7762-30928	92	920	0.304
T10-950-75	7762-30957	95	950	0.314
T10-960-75	7762-30968	96	960	0.317
T10-970-75	7762-30978	97	970	0.32
T10-980-75	7762-30988	98	980	0.323
T10-1000-75	7762-31007	100	1000	0.33
T10-1010-75	7762-31018	101	1010	0.333
T10-1050-75	7762-31058	105	1050	0.347
T10-1080-75	7762-31088	108	1080	0.356
T10-1100-75	7762-31107	110	1100	0.363
T10-1110-75	7762-31118	111	1110	0.366
T10-1140-75	7762-31148	114	1140	0.376
T10-1150-75	7762-31158	115	1150	0.38
T10-1200-75	7762-31208	120	1200	0.396
T10-1210-75	7762-31218	121	1210	0.399
T10-1240-75	7762-31248	124	1240	0.409
T10-1250-75	7762-31258	125	1250	0.413
T10-1300-75	7762-31308	130	1300	0.429

Part Number	Product Number	Number of Teeth	Pitch Length (mm)	Weight [kg]
T10-1320-75	7762-31328	132	1320	0.436
T10-1350-75	7762-31358	135	1350	0.446
T10-1390-75	7762-31398	139	1390	0.459
T10-1400-75	7762-31408	140	1400	0.462
T10-1420-75	7762-31428	142	1420	0.469
T10-1440-75	7762-31448	144	1440	0.475
T10-1450-75	7762-31458	145	1450	0.479
T10-1460-75	7762-31468	146	1460	0.482
T10-1500-75	7762-31508	150	1500	0.495
T10-1560-75	7762-31568	156	1560	0.515
T10-1600-75	7762-31607	160	1600	0.528
T10-1610-75	7762-31618	161	1610	0.531
T10-1700-75	7762-31707	170	1700	0.561
T10-1750-75	7762-31758	175	1750	0.578
T10-1780-75	7762-31788	178	1780	0.587
T10-1800-75	7762-31808	180	1800	0.594
T10-1880-75	7762-31888	188	1880	0.62
T10-1960-75	7762-31968	196	1960	0.647
T10-2250-75	7762-32258	225	2250	0.743

SYNCHRO-POWER T10-SLEEVE

Part Number	Product Number	Number of Teeth	Pitch Length (mm)	Weight [kg]	Sleeve Width [mm]	Cord
T10-260	7761-30260	26	260	0.229	200	Steel
T10-320	7761-30320	32	320	0.282	200	Steel
T10-370	7761-30369	37	370	0.619	380	Steel
T10-400	7761-30400	40	400	0.669	380	Steel
T10-410	7761-30410	41	410	0.686	380	Steel
T10-440	7761-30440	44	440	0.735	380	Steel
T10-450	7761-30450	45	450	0.752	380	Steel
T10-500	7761-30500	50	500	0.836	380	Steel
T10-530	7761-30530	53	530	0.886	380	Steel
T10-550	7761-30550	55	550	0.92	380	Steel
T10-560	7761-30560	56	560	0.936	380	Steel
T10-600	7761-30600	60	600	1.003	380	Steel
T10-610	7761-30610	61	610	1.02	380	Steel
T10-630	7761-30630	63	630	1.053	380	Steel
T10-650	7761-30650	65	650	1.087	380	Steel
T10-660	7761-30660	66	660	1.104	380	Steel
T10-690	7761-30690	69	690	1.154	380	Steel
T10-700	7761-30700	70	700	1.17	380	Steel
T10-720	7761-30720	72	720	1.204	380	Steel
T10-750	7761-30750	75	750	1.254	380	Steel
T10-780	7761-30780	78	780	1.304	380	Steel
T10-800	7761-30800	80	800	1.338	380	Steel
T10-810	7761-30810	81	810	1.354	380	Steel
T10-840	7761-30840	84	840	1.404	380	Steel
T10-850	7761-30850	85	850	1.421	380	Steel
T10-880	7761-30880	88	880	1.471	380	Steel
T10-890	7761-30890	89	890	1.488	380	Steel
T10-900	7761-30900	90	900	1.505	380	Steel
T10-910	7761-30910	91	910	1.522	380	Steel
T10-920	7761-30920	92	920	1.538	380	Steel
T10-950	7761-30950	95	950	1.588	380	Steel
T10-960	7761-30960	96	960	1.605	380	Steel
T10-970	7761-30970	97	970	1.622	380	Steel
T10-980	7761-30980	98	980	1.639	380	Steel
T10-1000	7761-31000	100	1000	1.672	380	Steel
T10-1010	7761-31010	101	1010	1.689	380	Steel
T10-1050	7761-31050	105	1050	1.756	380	Steel
T10-1080	7761-31080	108	1080	1.806	380	Steel
T10-1100	7761-31100	110	1100	1.839	380	Steel
T10-1110	7761-31110	111	1110	1.856	380	Steel
T10-1140	7761-31140	114	1140	1.906	380	Steel
T10-1150	7761-31150	115	1150	1.95	380	Steel
T10-1200	7761-31200	120	1200	2.006	380	Steel
T10-1210	7761-31210	121	1210	2.023	380	Steel
T10-1240	7761-31240	124	1240	2.073	380	Steel
T10-1250	7761-31250	125	1250	2.09	380	Steel

Part Number	Product Number	Number of Teeth	Pitch Length (mm)	Weight [kg]	Sleeve Width [mm]	Cord
T10-1300	7761-31300	130	1300	2.174	380	Steel
T10-1320	7761-31320	132	1320	2.207	380	Steel
T10-1350	7761-31350	135	1350	2.257	380	Steel
T10-1390	7761-31390	139	1390	2.324	380	Steel
T10-1400	7761-31400	140	1400	2.341	380	Steel
T10-1420	7761-31420	142	1420	2.374	380	Steel
T10-1440	7761-31440	144	1440	2.408	380	Steel
T10-1450	7761-31450	145	1450	2.424	380	Steel
T10-1460	7761-31460	146	1460	2.441	380	Steel
T10-1500	7761-31500	150	1500	2.508	380	Steel
T10-1560	7761-31560	156	1560	2.608	380	Steel
T10-1600	7761-31603	160	1600	1.408	200	Steel
T10-1610	7761-31613	161	1610	1.417	200	Steel
T10-1700	7761-31703	170	1700	1.525	200	Steel
T10-1750	7761-31753	175	1750	1.54	200	Steel
T10-1780	7761-31783	178	1780	1.566	200	Steel
T10-1800	7761-31800	180	1800	1.785	200	Steel
T10-1880	7761-31883	188	1880	1.654	200	Steel
T10-1960	7761-31963	196	1960	1.768	200	Steel
T10-2250	7761-32253	225	2250	2.045	200	Steel



SYNCHRO-POWER T10-SLEEVE

Part Number	Product Number	Number of Teeth	Pitch Length (mm)	Weight [kg]	Sleeve Width [mm]	Cord
T10-260-AR	7761-30262	26	260	0.229	200	Aramid
T10-320-AR	7761-30322	32	320	0.282	200	Aramid
T10-370-AR	7761-30362	37	370	0.619	380	Aramid
T10-400-AR	7761-30402	40	400	0.669	380	Aramid
T10-410-AR	7761-30412	41	410	0.686	380	Aramid
T10-440-AR	7761-30442	44	440	0.736	380	Aramid
T10-450-AR	7761-30452	45	450	0.752	380	Aramid
T10-500-AR	7761-30502	50	500	0.836	380	Aramid
T10-530-AR	7761-30532	53	530	0.886	380	Aramid
T10-550-AR	7761-30552	55	550	0.92	380	Aramid
T10-560-AR	7761-30562	56	560	0.936	380	Aramid
T10-600-AR	7761-30602	60	600	1.003	380	Aramid
T10-610-AR	7761-30612	61	610	1.02	380	Aramid
T10-630-AR	7761-30632	63	630	1.053	380	Aramid
T10-650-AR	7761-30652	65	650	1.087	380	Aramid
T10-660-AR	7761-30662	66	660	1.104	380	Aramid
T10-690-AR	7761-30692	69	690	1.154	380	Aramid
T10-700-AR	7761-30702	70	700	1.17	380	Aramid
T10-720-AR	7761-30722	72	720	1.204	380	Aramid
T10-750-AR	7761-30752	75	750	1.254	380	Aramid
T10-780-AR	7761-30782	78	780	1.304	380	Aramid
T10-800-AR	7761-30802	80	800	1.338	380	Aramid
T10-810-AR	7761-30812	81	810	1.354	380	Aramid
T10-840-AR	7761-30842	84	840	1.404	380	Aramid
T10-850-AR	7761-30852	85	850	1.421	380	Aramid
T10-880-AR	7761-30882	88	880	1.471	380	Aramid
T10-890-AR	7761-30892	89	890	1.488	380	Aramid
T10-900-AR	7761-30902	90	900	1.505	380	Aramid
T10-910-AR	7761-30912	91	910	1.522	380	Aramid
T10-920-AR	7761-30922	92	920	1.538	380	Aramid
T10-950-AR	7761-30952	95	950	1.588	380	Aramid
T10-960-AR	7761-30962	96	960	1.605	380	Aramid
T10-970-AR	7761-30972	97	970	1.622	380	Aramid
T10-980-AR	7761-30982	98	980	1.639	380	Aramid
T10-1000-AR	7761-31002	100	1000	1.672	380	Aramid
T10-1010-AR	7761-31012	101	1010	1.689	380	Aramid
T10-1050-AR	7761-31052	105	1050	1.756	380	Aramid
T10-1080-AR	7761-31082	108	1080	1.806	380	Aramid
T10-1100-AR	7761-31102	110	1100	1.839	380	Aramid
T10-1110-AR	7761-31112	111	1110	1.856	380	Aramid
T10-1140-AR	7761-31142	114	1140	1.906	380	Aramid
T10-1150-AR	7761-31152	115	1150	1.923	380	Aramid
T10-1200-AR	7761-31202	120	1200	2.006	380	Aramid
T10-1210-AR	7761-31212	121	1210	2.023	380	Aramid
T10-1240-AR	7761-31242	124	1240	2.073	380	Aramid
T10-1250-AR	7761-31252	125	1250	2.09	380	Aramid

Part Number	Product Number	Number of Teeth	Pitch Length (mm)	Weight [kg]	Sleeve Width [mm]	Cord
T10-1300-AR	7761-31302	130	1300	2.174	380	Aramid
T10-1320-AR	7761-31322	132	1320	2.207	380	Aramid
T10-1350-AR	7761-31352	135	1350	2.257	380	Aramid
T10-1390-AR	7761-31392	139	1390	2.324	380	Aramid
T10-1400-AR	7761-31402	140	1400	2.341	380	Aramid
T10-1420-AR	7761-31422	142	1420	2.374	380	Aramid
T10-1440-AR	7761-31442	144	1440	2.408	380	Aramid
T10-1450-AR	7761-31452	145	1450	2.424	380	Aramid
T10-1460-AR	7761-31462	146	1460	2.441	380	Aramid
T10-1500-AR	7761-31502	150	1500	2.508	380	Aramid
T10-1560-AR	7761-31562	156	1560	2.608	380	Aramid
T10-1600-AR	7761-31602	160	1600	1.408	200	Aramid
T10-1610-AR	7761-31612	161	1610	1.417	200	Aramid
T10-1700-AR	7761-31702	170	1700	1.496	200	Aramid
T10-1750-AR	7761-31752	175	1750	1.54	200	Aramid
T10-1780-AR	7761-31782	178	1780	1.566	200	Aramid
T10-1800-AR	7761-31802	180	1800	1.584	200	Aramid
T10-1880-AR	7761-31882	188	1880	1.654	200	Aramid
T10-1960-AR	7761-31962	196	1960	1.725	200	Aramid
T10-2250-AR	7761-32252	225	2250	1.98	200	Aramid



SYNCHRO-POWER AT5-4 BELT

Part Number	Product Number	Number of Teeth	Pitch Length (mm)	Weight [kg]
AT5-225-4	7762-50226	45	225	0.003
AT5-280-4	7762-50286	56	280	0.004
AT5-300-4	7762-50306	60	300	0.004
AT5-340-4	7762-50346	68	340	0.005
AT5-375-4	7762-50376	75	375	0.005
AT5-390-4	7762-50396	78	390	0.005
AT5-420-4	7762-50426	84	420	0.006
AT5-450-4	7762-50446	90	450	0.006
AT5-455-4	7762-50456	91	455	0.006
AT5-500-4	7762-50506	100	500	0.007
AT5-545-4	7762-50546	109	545	0.007
AT5-600-4	7762-50606	120	600	0.008
AT5-610-4	7762-50616	122	610	0.008
AT5-660-4	7762-50666	132	660	0.009
AT5-710-4	7762-50716	142	710	0.01
AT5-720-4	7762-50726	144	720	0.01
AT5-750-4	7762-50756	150	750	0.01
AT5-780-4	7762-50786	156	780	0.011
AT5-825-4	7762-50826	165	825	0.011
AT5-860-4	7762-50866	172	860	0.012
AT5-975-4	7762-50976	195	975	0.013
AT5-1050-4	7762-51056	210	1050	0.014
AT5-1500-4	7762-51506	300	1500	0.02

SYNCHRO-POWER AT5-6 BELT

Part Number	Product Number	Number of Teeth	Pitch Length (mm)	Weight [kg]
AT5-225-6	7762-50227	45	225	0.005
AT5-280-6	7762-50287	56	280	0.006
AT5-300-6	7762-50307	60	300	0.006
AT5-340-6	7762-50347	68	340	0.007
AT5-375-6	7762-50377	75	375	0.008
AT5-390-6	7762-50397	78	390	0.008
AT5-420-6	7762-50427	84	420	0.009
AT5-450-6	7762-50447	90	450	0.009
AT5-455-6	7762-50457	91	455	0.009
AT5-500-6	7762-50507	100	500	0.01
AT5-545-6	7762-50547	109	545	0.011
AT5-600-6	7762-50607	120	600	0.012
AT5-610-6	7762-50617	122	610	0.012
AT5-660-6	7762-50667	132	660	0.013
AT5-710-6	7762-50717	142	710	0.014
AT5-720-6	7762-50727	144	720	0.015
AT5-750-6	7762-50757	150	750	0.015
AT5-780-6	7762-50787	156	780	0.016
AT5-825-6	7762-50827	165	825	0.017
AT5-860-6	7762-50867	172	860	0.018
AT5-975-6	7762-50977	195	975	0.02
AT5-1050-6	7762-51057	210	1050	0.021
AT5-1500-6	7762-51507	300	1500	0.031



SYNCHRO-POWER AT5-8 BELT

Part Number	Product Number	Number of Teeth	Pitch Length (mm)	Weight [kg]
AT5-225-8	7762-50228	45	225	0.006
AT5-280-8	7762-50288	56	280	0.008
AT5-300-8	7762-50308	60	300	0.008
AT5-340-8	7762-50348	68	340	0.009
AT5-375-8	7762-50378	75	375	0.01
AT5-390-8	7762-50398	78	390	0.011
AT5-420-8	7762-50428	84	420	0.011
AT5-450-8	7762-50448	90	450	0.012
AT5-455-8	7762-50458	91	455	0.012
AT5-500-8	7762-50508	100	500	0.014
AT5-545-8	7762-50548	109	545	0.015
AT5-600-8	7762-50608	120	600	0.016
AT5-610-8	7762-50618	122	610	0.017
AT5-660-8	7762-50668	132	660	0.018
AT5-710-8	7762-50718	142	710	0.019
AT5-720-8	7762-50728	144	720	0.02
AT5-750-8	7762-50758	150	750	0.02
AT5-780-8	7762-50788	156	780	0.021
AT5-825-8	7762-50828	165	825	0.022
AT5-860-8	7762-50868	172	860	0.023
AT5-975-8	7762-50978	195	975	0.027
AT5-1050-8	7762-51058	210	1050	0.029
AT5-1500-8	7762-51508	300	1500	0.041

SYNCHRO-POWER AT5-10 BELT

Part Number	Product Number	Number of Teeth	Pitch Length (mm)	Weight [kg]
AT5-225-10	7762-50221	45	225	0.008
AT5-280-10	7762-50281	56	280	0.01
AT5-300-10	7762-50301	60	300	0.01
AT5-340-10	7762-50341	68	340	0.012
AT5-375-10	7762-50371	75	375	0.013
AT5-390-10	7762-50391	78	390	0.013
AT5-420-10	7762-50421	84	420	0.014
AT5-450-10	7762-50441	90	450	0.015
AT5-455-10	7762-50451	91	455	0.015
AT5-500-10	7762-50501	100	500	0.017
AT5-545-10	7762-50541	109	545	0.019
AT5-600-10	7762-50601	120	600	0.02
AT5-610-10	7762-50611	122	610	0.021
AT5-660-10	7762-50661	132	660	0.022
AT5-710-10	7762-50711	142	710	0.024
AT5-720-10	7762-50721	144	720	0.024
AT5-750-10	7762-50751	150	750	0.026
AT5-780-10	7762-50781	156	780	0.027
AT5-825-10	7762-50821	165	825	0.028
AT5-860-10	7762-50861	172	860	0.029
AT5-975-10	7762-50971	195	975	0.033
AT5-1050-10	7762-51051	210	1050	0.036
AT5-1500-10	7762-51501	300	1500	0.051



SYNCHRO-POWER AT5-12 BELT

Part Number	Product Number	Number of Teeth	Pitch Length (mm)	Weight [kg]
AT5-225-12	7762-50229	45	225	0.009
AT5-280-12	7762-50289	56	280	0.011
AT5-300-12	7762-50309	60	300	0.012
AT5-340-12	7762-50349	68	340	0.014
AT5-375-12	7762-50379	75	375	0.015
AT5-390-12	7762-50399	78	390	0.016
AT5-420-12	7762-50429	84	420	0.017
AT5-450-12	7762-50449	90	450	0.018
AT5-455-12	7762-50459	91	455	0.019
AT5-500-12	7762-50509	100	500	0.02
AT5-545-12	7762-50549	109	545	0.022
AT5-600-12	7762-50609	120	600	0.024
AT5-610-12	7762-50619	122	610	0.025
AT5-660-12	7762-50669	132	660	0.027
AT5-710-12	7762-50719	142	710	0.029
AT5-720-12	7762-50729	144	720	0.029
AT5-750-12	7762-50759	150	750	0.031
AT5-780-12	7762-50789	156	780	0.032
AT5-825-12	7762-50829	165	825	0.034
AT5-860-12	7762-50869	172	860	0.035
AT5-975-12	7762-50979	195	975	0.04
AT5-1050-12	7762-51059	210	1050	0.043
AT5-1500-12	7762-51509	300	1500	0.061

SYNCHRO-POWER AT5-16 BELT

Part Number	Product Number	Number of Teeth	Pitch Length (mm)	Weight [kg]
AT5-225-16	7762-50222	45	225	0.012
AT5-280-16	7762-50282	56	280	0.015
AT5-300-16	7762-50302	60	300	0.016
AT5-340-16	7762-50342	68	340	0.018
AT5-375-16	7762-50372	75	375	0.02
AT5-390-16	7762-50392	78	390	0.021
AT5-420-16	7762-50422	84	420	0.023
AT5-450-16	7762-50442	90	450	0.024
AT5-455-16	7762-50452	91	455	0.025
AT5-500-16	7762-50502	100	500	0.027
AT5-545-16	7762-50542	109	545	0.03
AT5-600-16	7762-50602	120	600	0.033
AT5-610-16	7762-50612	122	610	0.033
AT5-660-16	7762-50662	132	660	0.036
AT5-710-16	7762-50712	142	710	0.039
AT5-720-16	7762-50722	144	720	0.039
AT5-750-16	7762-50752	150	750	0.041
AT5-780-16	7762-50782	156	780	0.042
AT5-825-16	7762-50822	165	825	0.045
AT5-860-16	7762-50862	172	860	0.047
AT5-975-16	7762-50972	195	975	0.053
AT5-1050-16	7762-51052	210	1050	0.057
AT5-1500-16	7762-51502	300	1500	0.082



SYNCHRO-POWER AT5-20 BELT

Part Number	Product Number	Number of Teeth	Pitch Length (mm)	Weight [kg]
AT5-225-20	7762-50230	45	225	0.015
AT5-280-20	7762-50290	56	280	0.019
AT5-300-20	7762-50310	60	300	0.02
AT5-340-20	7762-50350	68	340	0.023
AT5-375-20	7762-50380	75	375	0.026
AT5-390-20	7762-50400	78	390	0.027
AT5-420-20	7762-50430	84	420	0.029
AT5-450-20	7762-50440	90	450	0.031
AT5-455-20	7762-50460	91	455	0.031
AT5-500-20	7762-50510	100	500	0.034
AT5-545-20	7762-50550	109	545	0.037
AT5-600-20	7762-50610	120	600	0.041
AT5-660-20	7762-50670	132	660	0.045
AT5-710-20	7762-50709	142	710	0.048
AT5-720-20	7762-50730	144	720	0.049
AT5-750-20	7762-50760	150	750	0.051
AT5-780-20	7762-50790	156	780	0.053
AT5-825-20	7762-50830	165	825	0.056
AT5-860-20	7762-50870	172	860	0.058
AT5-975-20	7762-50980	195	975	0.066
AT5-1050-20	7762-51060	210	1050	0.071
AT5-1500-20	7762-51510	300	1500	0.102

SYNCHRO-POWER AT5-25 BELT

Part Number	Product Number	Number of Teeth	Pitch Length (mm)	Weight [kg]
AT5-225-25	7762-50223	45	225	0.019
AT5-280-25	7762-50283	56	280	0.024
AT5-300-25	7762-50303	60	300	0.026
AT5-340-25	7762-50343	68	340	0.029
AT5-375-25	7762-50373	75	375	0.032
AT5-390-25	7762-50393	78	390	0.033
AT5-420-25	7762-50423	84	420	0.036
AT5-450-25	7762-50443	90	450	0.038
AT5-455-25	7762-50453	91	455	0.039
AT5-500-25	7762-50503	100	500	0.043
AT5-545-25	7762-50543	109	545	0.046
AT5-600-25	7762-50603	120	600	0.051
AT5-610-25	7762-50613	122	610	0.052
AT5-660-25	7762-50663	132	660	0.056
AT5-710-25	7762-50713	142	710	0.06
AT5-720-25	7762-50723	144	720	0.061
AT5-750-25	7762-50753	150	750	0.064
AT5-780-25	7762-50783	156	780	0.066
AT5-825-25	7762-50823	165	825	0.07
AT5-860-25	7762-50863	172	860	0.073
AT5-975-25	7762-50973	195	975	0.083
AT5-1050-25	7762-51053	210	1050	0.089
AT5-1500-25	7762-51503	300	1500	0.128

SYNCHRO-POWER AT5-32 BELT

Part Number	Product Number	Number of Teeth	Pitch Length (mm)	Weight [kg]
AT5-225-32	7762-50224	45	225	0.024
AT5-280-32	7762-50284	56	280	0.03
AT5-300-32	7762-50304	60	300	0.033
AT5-340-32	7762-50344	68	340	0.037
AT5-375-32	7762-50374	75	375	0.041
AT5-390-32	7762-50394	78	390	0.042
AT5-420-32	7762-50424	84	420	0.046
AT5-450-32	7762-50444	90	450	0.049
AT5-455-32	7762-50454	91	455	0.05
AT5-500-32	7762-50504	100	500	0.054
AT5-545-32	7762-50544	109	545	0.059
AT5-600-32	7762-50604	120	600	0.065
AT5-610-32	7762-50614	122	610	0.066
AT5-660-32	7762-50664	132	660	0.072
AT5-710-32	7762-50714	142	710	0.077
AT5-720-32	7762-50724	144	720	0.078
AT5-750-32	7762-50754	150	750	0.082
AT5-780-32	7762-50784	156	780	0.085
AT5-825-32	7762-50824	165	825	0.09
AT5-860-32	7762-50864	172	860	0.094
AT5-975-32	7762-50974	195	975	0.106
AT5-1050-32	7762-51054	210	1050	0.114
AT5-1500-32	7762-51504	300	1500	0.163

SYNCHRO-POWER AT5-50 BELT

Part Number	Product Number	Number of Teeth	Pitch Length (mm)	Weight [kg]
AT5-225-50	7762-50225	45	225	0.038
AT5-280-50	7762-50285	56	280	0.048
AT5-300-50	7762-50305	60	300	0.051
AT5-340-50	7762-50345	68	340	0.058
AT5-375-50	7762-50375	75	375	0.064
AT5-390-50	7762-50395	78	390	0.066
AT5-420-50	7762-50425	84	420	0.071
AT5-450-50	7762-50445	90	450	0.077
AT5-455-50	7762-50455	91	455	0.077
AT5-500-50	7762-50505	100	500	0.085
AT5-545-50	7762-50545	109	545	0.093
AT5-600-50	7762-50605	120	600	0.102
AT5-610-50	7762-50615	122	610	0.104
AT5-660-50	7762-50665	132	660	0.112
AT5-710-50	7762-50715	142	710	0.121
AT5-720-50	7762-50725	144	720	0.122
AT5-750-50	7762-50755	150	750	0.128
AT5-780-50	7762-50785	156	780	0.133
AT5-825-50	7762-50825	165	825	0.14
AT5-860-50	7762-50865	172	860	0.146
AT5-975-50	7762-50975	195	975	0.166
AT5-1050-50	7762-51055	210	1050	0.179
AT5-1500-50	7762-51505	300	1500	0.255



SYNCHRO-POWER AT5-75 BELT

Part Number	Product Number	Number of Teeth	Pitch Length (mm)	Weight [kg]
AT5-225-75	7762-50231	45	225	0.057
AT5-280-75	7762-50291	56	280	0.071
AT5-300-75	7762-50311	60	300	0.077
AT5-340-75	7762-50351	68	340	0.087
AT5-375-75	7762-50381	75	375	0.096
AT5-390-75	7762-50401	78	390	0.099
AT5-420-75	7762-50431	84	420	0.107
AT5-450-75	7762-50439	90	450	0.115
AT5-455-75	7762-50461	91	455	0.116
AT5-500-75	7762-50511	100	500	0.128
AT5-545-75	7762-50551	109	545	0.139
AT5-600-75	7762-50642	120	600	0.153
AT5-610-75	7762-50643	122	610	0.156
AT5-660-75	7762-50671	132	660	0.168
AT5-710-75	7762-50708	142	710	0.181
AT5-720-75	7762-50731	144	720	0.184
AT5-750-75	7762-50761	150	750	0.191
AT5-780-75	7762-50791	156	780	0.199
AT5-825-75	7762-50831	165	825	0.21
AT5-860-75	7762-50871	172	860	0.219
AT5-975-75	7762-50981	195	975	0.249
AT5-1050-75	7762-51061	210	1050	0.268
AT5-1500-75	7762-51511	300	1500	0.383



SYNCHRO-POWER AT5-SLEEVE

Part Number	Product Number	Number of Teeth	Pitch Length (mm)	Weight [kg]	Sleeve Width [mm]	Cord
AT5-225	7761-50225	45	225	0.153	200	Steel
AT5-280	7761-50280	56	280	0.19	200	Steel
AT5-300	7761-50300	60	300	0.204	200	Steel
AT5-340	7761-50339	68	340	0.421	380	Steel
AT5-375	7761-50374	75	375	0.485	380	Steel
AT5-390	7761-50389	78	390	0.504	380	Steel
AT5-420	7761-50420	84	420	0.543	380	Steel
AT5-450	7761-50450	90	450	0.581	380	Steel
AT5-455	7761-50455	91	455	0.588	380	Steel
AT5-500	7761-50500	100	500	0.646	380	Steel
AT5-545	7761-50545	109	545	0.704	380	Steel
AT5-600	7761-50600	120	600	0.775	380	Steel
AT5-610	7761-50610	122	610	0.788	380	Steel
AT5-660	7761-50660	132	660	0.853	380	Steel
AT5-710	7761-50710	142	710	0.917	380	Steel
AT5-720	7761-50720	144	720	0.93	380	Steel
AT5-750	7761-50750	150	750	0.969	380	Steel
AT5-780	7761-50780	156	780	1.008	380	Steel
AT5-825	7761-50825	165	825	1.066	380	Steel
AT5-860	7761-50860	172	860	1.111	380	Steel
AT5-975	7761-50975	195	975	1.26	380	Steel
AT5-1050	7761-51050	210	1050	1.357	380	Steel
AT5-1500	7761-51500	300	1500	1.938	380	Steel

Part Number	Product Number	Number of Teeth	Pitch Length (mm)	Weight [kg]	Sleeve Width [mm]	Cord
AT5-225-AR	7761-50222	45	225	0.153	200	AR
AT5-280-AR	7761-50282	56	280	0.19	200	AR
AT5-300-AR	7761-50302	60	300	0.204	200	AR
AT5-340-AR	7761-50332	68	340	0.439	380	AR
AT5-375-AR	7761-50372	75	375	0.485	380	AR
AT5-390-AR	7761-50382	78	390	0.504	380	AR
AT5-420-AR	7761-50422	84	420	0.543	380	AR
AT5-450-AR	7761-50451	90	450	0.581	380	AR
AT5-455-AR	7761-50452	91	455	0.588	380	AR
AT5-500-AR	7761-50502	100	500	0.646	380	AR
AT5-545-AR	7761-50542	109	545	0.704	380	AR
AT5-600-AR	7761-50602	120	600	0.775	380	AR
AT5-610-AR	7761-50612	122	610	0.788	380	AR
AT5-660-AR	7761-50662	132	660	0.853	380	AR
AT5-710-AR	7761-50712	142	710	0.917	380	AR
AT5-720-AR	7761-50722	144	720	0.93	380	AR
AT5-750-AR	7761-50752	150	750	0.969	380	AR
AT5-780-AR	7761-50782	156	780	1.008	380	AR
AT5-825-AR	7761-50822	165	825	1.066	380	AR
AT5-860-AR	7761-50862	172	860	1.111	380	AR
AT5-975-AR	7761-50972	195	975	1.26	380	AR
AT5-1050-AR	7761-51052	210	1050	1.357	380	AR
AT5-1500-AR	7761-51502	300	1500	1.938	380	AR



SYNCHRO-POWER AT10-10 BELT

Part Number	Product Number	Number of Teeth	Pitch Length (mm)	Weight [kg]
AT10-500-10	7762-60501	50	500	0.033
AT10-560-10	7762-60561	56	560	0.036
AT10-610-10	7762-60611	61	610	0.04
AT10-660-10	7762-60661	66	660	0.043
AT10-700-10	7762-60701	70	700	0.046
AT10-730-10	7762-60731	73	730	0.047
AT10-780-10	7762-60781	78	780	0.051
AT10-800-10	7762-60801	80	800	0.052
AT10-840-10	7762-60841	84	840	0.055
AT10-890-10	7762-60891	89	890	0.058
AT10-920-10	7762-60921	92	920	0.06
AT10-960-10	7762-60961	96	960	0.062
AT10-980-10	7762-60981	98	980	0.064
AT10-1010-10	7762-61011	101	1010	0.066
AT10-1050-10	7762-61051	105	1050	0.068
AT10-1080-10	7762-61081	108	1080	0.07
AT10-1100-10	7762-61101	110	1100	0.072
AT10-1150-10	7762-61151	115	1150	0.075
AT10-1200-10	7762-61201	120	1200	0.078
AT10-1210-10	7762-61211	121	1210	0.079
AT10-1250-10	7762-61251	125	1250	0.081
AT10-1280-10	7762-61281	128	1280	0.083
AT10-1320-10	7762-61321	132	1320	0.086
AT10-1350-10	7762-61351	135	1350	0.088
AT10-1360-10	7762-61361	136	1360	0.088
AT10-1400-10	7762-61401	140	1400	0.091
AT10-1420-10	7762-61421	142	1420	0.092
AT10-1480-10	7762-61481	148	1480	0.096
AT10-1500-10	7762-61501	150	1500	0.098
AT10-1600-10	7762-61601	160	1600	0.104
AT10-1700-10	7762-61701	170	1700	0.111
AT10-1800-10	7762-61801	180	1800	0.117
AT10-1860-10	7762-61861	186	1860	0.121
AT10-1940-10	7762-61941	194	1940	0.126

SYNCHRO-POWER AT10-12 BELT

Part Number	Product Number	Number of Teeth	Pitch Length (mm)	Weight [kg]
AT10-500-12	7762-60506	50	500	0.039
AT10-560-12	7762-60566	56	560	0.044
AT10-610-12	7762-60616	61	610	0.048
AT10-660-12	7762-60666	66	660	0.051
AT10-700-12	7762-60706	70	700	0.055
AT10-730-12	7762-60736	73	730	0.057
AT10-780-12	7762-60786	78	780	0.061
AT10-800-12	7762-60806	80	800	0.062
AT10-840-12	7762-60846	84	840	0.066
AT10-890-12	7762-60896	89	890	0.069
AT10-920-12	7762-60926	92	920	0.072
AT10-960-12	7762-60966	96	960	0.075
AT10-980-12	7762-60986	98	980	0.076
AT10-1010-12	7762-61016	101	1010	0.079
AT10-1050-12	7762-61056	105	1050	0.082
AT10-1080-12	7762-61086	108	1080	0.084
AT10-1100-12	7762-61106	110	1100	0.086
AT10-1150-12	7762-61156	115	1150	0.09
AT10-1200-12	7762-61206	120	1200	0.094
AT10-1210-12	7762-61216	121	1210	0.094
AT10-1250-12	7762-61256	125	1250	0.098
AT10-1280-12	7762-61286	128	1280	0.1
AT10-1320-12	7762-61326	132	1320	0.103
AT10-1350-12	7762-61356	135	1350	0.105
AT10-1360-12	7762-61366	136	1360	0.106
AT10-1400-12	7762-61406	140	1400	0.109
AT10-1420-12	7762-61426	142	1420	0.111
AT10-1480-12	7762-61486	148	1480	0.115
AT10-1500-12	7762-61506	150	1500	0.117
AT10-1600-12	7762-61606	160	1600	0.125
AT10-1700-12	7762-61706	170	1700	0.133
AT10-1800-12	7762-61806	180	1800	0.14
AT10-1860-12	7762-61866	186	1860	0.145
AT10-1940-12	7762-61946	194	1940	0.151

SYNCHRO-POWER AT10-16 BELT

Part Number	Product Number	Number of Teeth	Pitch Length (mm)	Weight [kg]
AT10-500-16	7762-60502	50	500	0.052
AT10-560-16	7762-60562	56	560	0.055
AT10-610-16	7762-60612	61	610	0.063
AT10-660-16	7762-60662	66	660	0.069
AT10-700-16	7762-60702	70	700	0.073
AT10-730-16	7762-60732	73	730	0.076
AT10-780-16	7762-60782	78	780	0.081
AT10-800-16	7762-60802	80	800	0.083
AT10-840-16	7762-60842	84	840	0.087
AT10-890-16	7762-60892	89	890	0.093
AT10-920-16	7762-60922	92	920	0.096
AT10-960-16	7762-60962	96	960	0.1
AT10-980-16	7762-60982	98	980	0.102
AT10-1010-16	7762-61012	101	1010	0.105
AT10-1050-16	7762-61052	105	1050	0.109
AT10-1080-16	7762-61082	108	1080	0.112
AT10-1100-16	7762-61102	110	1100	0.114
AT10-1150-16	7762-61152	115	1150	0.12
AT10-1200-16	7762-61202	120	1200	0.125
AT10-1210-16	7762-61212	121	1210	0.126
AT10-1250-16	7762-61252	125	1250	0.13
AT10-1280-16	7762-61282	128	1280	0.133
AT10-1320-16	7762-61322	132	1320	0.137
AT10-1350-16	7762-61352	135	1350	0.14
AT10-1360-16	7762-61362	136	1360	0.141
AT10-1400-16	7762-61402	140	1400	0.146
AT10-1420-16	7762-61422	142	1420	0.148
AT10-1480-16	7762-61482	148	1480	0.154
AT10-1500-16	7762-61502	150	1500	0.156
AT10-1600-16	7762-61602	160	1600	0.166
AT10-1700-16	7762-61702	170	1700	0.177
AT10-1800-16	7762-61802	180	1800	0.187
AT10-1860-16	7762-61862	186	1860	0.193
AT10-1940-16	7762-61942	194	1940	0.202

SYNCHRO-POWER AT10-20 BELT

Part Number	Product Number	Number of Teeth	Pitch Length (mm)	Weight [kg]
AT10-500-20	7762-60507	50	500	0.065
AT10-560-20	7762-60567	56	560	0.073
AT10-610-20	7762-60617	61	610	0.079
AT10-660-20	7762-60667	66	660	0.086
AT10-700-20	7762-60707	70	700	0.091
AT10-730-20	7762-60737	73	730	0.095
AT10-780-20	7762-60787	78	780	0.101
AT10-800-20	7762-60807	80	800	0.104
AT10-840-20	7762-60847	84	840	0.109
AT10-890-20	7762-60897	89	890	0.116
AT10-920-20	7762-60927	92	920	0.12
AT10-960-20	7762-60967	96	960	0.125
AT10-980-20	7762-60987	98	980	0.127
AT10-1010-20	7762-61017	101	1010	0.131
AT10-1050-20	7762-61057	105	1050	0.137
AT10-1080-20	7762-61087	108	1080	0.14
AT10-1100-20	7762-61107	110	1100	0.143
AT10-1150-20	7762-61157	115	1150	0.15
AT10-1200-20	7762-61207	120	1200	0.156
AT10-1210-20	7762-61217	121	1210	0.157
AT10-1250-20	7762-61257	125	1250	0.163
AT10-1280-20	7762-61287	128	1280	0.166
AT10-1320-20	7762-61327	132	1320	0.172
AT10-1350-20	7762-61357	135	1350	0.176
AT10-1360-20	7762-61367	136	1360	0.177
AT10-1400-20	7762-61407	140	1400	0.182
AT10-1420-20	7762-61427	142	1420	0.185
AT10-1480-20	7762-61487	148	1480	0.192
AT10-1500-20	7762-61507	150	1500	0.195
AT10-1600-20	7762-61607	160	1600	0.208
AT10-1700-20	7762-61707	170	1700	0.221
AT10-1800-20	7762-61807	180	1800	0.234
AT10-1860-20	7762-61867	186	1860	0.242
AT10-1940-20	7762-61947	194	1940	0.252



SYNCHRO-POWER AT10-25 BELT

Part Number	Product Number	Number of Teeth	Pitch Length (mm)	Weight [kg]
AT10-500-25	7762-60503	50	500	0.081
AT10-560-25	7762-60563	56	560	0.091
AT10-610-25	7762-60613	61	610	0.099
AT10-660-25	7762-60663	66	660	0.107
AT10-700-25	7762-60703	70	700	0.114
AT10-730-25	7762-60733	73	730	0.119
AT10-780-25	7762-60783	78	780	0.127
AT10-800-25	7762-60803	80	800	0.13
AT10-840-25	7762-60843	84	840	0.137
AT10-890-25	7762-60893	89	890	0.145
AT10-920-25	7762-60923	92	920	0.15
AT10-960-25	7762-60963	96	960	0.156
AT10-980-25	7762-60983	98	980	0.159
AT10-1010-25	7762-61013	101	1010	0.164
AT10-1050-25	7762-61053	105	1050	0.171
AT10-1080-25	7762-61083	108	1080	0.176
AT10-1100-25	7762-61103	110	1100	0.179
AT10-1150-25	7762-61153	115	1150	0.187
AT10-1200-25	7762-61203	120	1200	0.195
AT10-1210-25	7762-61213	121	1210	0.197
AT10-1250-25	7762-61253	125	1250	0.203
AT10-1280-25	7762-61283	128	1280	0.208
AT10-1320-25	7762-61323	132	1320	0.215
AT10-1350-25	7762-61353	135	1350	0.219
AT10-1360-25	7762-61363	136	1360	0.221
AT10-1400-25	7762-61403	140	1400	0.228
AT10-1420-25	7762-61423	142	1420	0.231
AT10-1480-25	7762-61483	148	1480	0.241
AT10-1500-25	7762-61503	150	1500	0.244
AT10-1600-25	7762-61603	160	1600	0.26
AT10-1700-25	7762-61703	170	1700	0.276
AT10-1800-25	7762-61803	180	1800	0.293
AT10-1860-25	7762-61863	186	1860	0.302
AT10-1940-25	7762-61943	194	1940	0.315

SYNCHRO-POWER AT10-32 BELT

Part Number	Product Number	Number of Teeth	Pitch Length (mm)	Weight [kg]
AT10-500-32	7762-60504	50	500	0.104
AT10-560-32	7762-60564	56	560	0.116
AT10-610-32	7762-60614	61	610	0.127
AT10-660-32	7762-60664	66	660	0.137
AT10-700-32	7762-60704	70	700	0.146
AT10-730-32	7762-60734	73	730	0.152
AT10-780-32	7762-60784	78	780	0.162
AT10-800-32	7762-60804	80	800	0.166
AT10-840-32	7762-60844	84	840	0.175
AT10-890-32	7762-60894	89	890	0.185
AT10-920-32	7762-60924	92	920	0.191
AT10-960-32	7762-60964	96	960	0.2
AT10-980-32	7762-60984	98	980	0.204
AT10-1010-32	7762-61014	101	1010	0.21
AT10-1050-32	7762-61054	105	1050	0.218
AT10-1080-32	7762-61084	108	1080	0.225
AT10-1100-32	7762-61104	110	1100	0.229
AT10-1150-32	7762-61154	115	1150	0.239
AT10-1200-32	7762-61204	120	1200	0.25
AT10-1210-32	7762-61214	121	1210	0.252
AT10-1250-32	7762-61254	125	1250	0.26
AT10-1280-32	7762-61284	128	1280	0.266
AT10-1320-32	7762-61324	132	1320	0.275
AT10-1350-32	7762-61354	135	1350	0.281
AT10-1360-32	7762-61364	136	1360	0.283
AT10-1400-32	7762-61404	140	1400	0.291
AT10-1420-32	7762-61424	142	1420	0.295
AT10-1480-32	7762-61484	148	1480	0.308
AT10-1500-32	7762-61504	150	1500	0.312
AT10-1600-32	7762-61604	160	1600	0.333
AT10-1700-32	7762-61704	170	1700	0.354
AT10-1800-32	7762-61804	180	1800	0.374
AT10-1860-32	7762-61864	186	1860	0.387
AT10-1940-32	7762-61944	194	1940	0.404

SYNCHRO-POWER AT10-50 BELT

Part Number	Product Number	Number of Teeth	Pitch Length (mm)	Weight [kg]
AT10-500-50	7762-60505	50	500	0.163
AT10-560-50	7762-60565	56	560	0.182
AT10-610-50	7762-60615	61	610	0.198
AT10-660-50	7762-60665	66	660	0.215
AT10-700-50	7762-60705	70	700	0.228
AT10-730-50	7762-60735	73	730	0.237
AT10-780-50	7762-60785	78	780	0.254
AT10-800-50	7762-60805	80	800	0.26
AT10-840-50	7762-60845	84	840	0.273
AT10-890-50	7762-60895	89	890	0.289
AT10-920-50	7762-60925	92	920	0.299
AT10-960-50	7762-60965	96	960	0.312
AT10-980-50	7762-60985	98	980	0.319
AT10-1010-50	7762-61015	101	1010	0.328
AT10-1050-50	7762-61055	105	1050	0.341
AT10-1080-50	7762-61085	108	1080	0.351
AT10-1100-50	7762-61105	110	1100	0.358
AT10-1150-50	7762-61155	115	1150	0.374
AT10-1200-50	7762-61205	120	1200	0.39
AT10-1210-50	7762-61215	121	1210	0.393
AT10-1250-50	7762-61255	125	1250	0.406
AT10-1280-50	7762-61285	128	1280	0.416
AT10-1320-50	7762-61325	132	1320	0.429
AT10-1350-50	7762-61355	135	1350	0.439
AT10-1360-50	7762-61365	136	1360	0.442
AT10-1400-50	7762-61405	140	1400	0.455
AT10-1420-50	7762-61425	142	1420	0.462
AT10-1480-50	7762-61485	148	1480	0.481
AT10-1500-50	7762-61505	150	1500	0.488
AT10-1600-50	7762-61605	160	1600	0.52
AT10-1700-50	7762-61705	170	1700	0.553
AT10-1800-50	7762-61805	180	1800	0.585
AT10-1860-50	7762-61865	186	1860	0.605
AT10-1940-50	7762-61945	194	1940	0.631

SYNCHRO-POWER AT10-75 BELT

Part Number	Product Number	Number of Teeth	Pitch Length (mm)	Weight [kg]
AT10-500-75	7762-60508	50	500	0.244
AT10-560-75	7762-60568	56	560	0.273
AT10-610-75	7762-60618	61	610	0.297
AT10-660-75	7762-60668	66	660	0.322
AT10-700-75	7762-60708	70	700	0.341
AT10-730-75	7762-60738	73	730	0.356
AT10-780-75	7762-60788	78	780	0.38
AT10-800-75	7762-60808	80	800	0.39
AT10-840-75	7762-60848	84	840	0.41
AT10-890-75	7762-60898	89	890	0.434
AT10-920-75	7762-60928	92	920	0.449
AT10-960-75	7762-60968	96	960	0.468
AT10-980-75	7762-60988	98	980	0.478
AT10-1010-75	7762-61018	101	1010	0.492
AT10-1050-75	7762-61058	105	1050	0.512
AT10-1080-75	7762-61088	108	1080	0.527
AT10-1100-75	7762-61108	110	1100	0.536
AT10-1150-75	7762-61158	115	1150	0.561
AT10-1200-75	7762-61208	120	1200	0.585
AT10-1210-75	7762-61218	121	1210	0.59
AT10-1250-75	7762-61258	125	1250	0.609
AT10-1280-75	7762-61288	128	1280	0.624
AT10-1320-75	7762-61328	132	1320	0.644
AT10-1350-75	7762-61358	135	1350	0.658
AT10-1360-75	7762-61368	136	1360	0.663
AT10-1400-75	7762-61408	140	1400	0.683
AT10-1420-75	7762-61428	142	1420	0.692
AT10-1480-75	7762-61488	148	1480	0.722
AT10-1500-75	7762-61508	150	1500	0.731
AT10-1600-75	7762-61608	160	1600	0.78
AT10-1700-75	7762-61708	170	1700	0.829
AT10-1800-75	7762-61808	180	1800	0.878
AT10-1860-75	7762-61868	186	1860	0.907
AT10-1940-75	7762-61948	194	1940	0.946



SYNCHRO-POWER AT10-SLEEVE

Part Number	Product Number	Number of Teeth	Pitch Length (mm)	Weight [kg]	Sleeve Width [mm]	Cord	Part Number	Product Number	Number of Teeth	Pitch Length (mm)	Weight [kg]	Sleeve Width [mm]	Cord
AT10-500	7761-60500	50	500	1.235	380	Steel	AT10-500-AR	7761-60502	50	500	1.235	380	AR
AT10-560	7761-60560	56	560	1.383	380	Steel	AT10-560-AR	7761-60562	56	560	1.383	380	AR
AT10-610	7761-60610	61	610	1.507	380	Steel	AT10-610-AR	7761-60612	61	610	1.507	380	AR
AT10-660	7761-60660	66	660	1.63	380	Steel	AT10-660-AR	7761-60662	66	660	1.63	380	AR
AT10-700	7761-60700	70	700	1.729	380	Steel	AT10-700-AR	7761-60702	70	700	1.729	380	AR
AT10-730	7761-60730	73	730	1.803	380	Steel	AT10-730-AR	7761-60732	73	730	1.803	380	AR
AT10-780	7761-60780	78	780	1.927	380	Steel	AT10-780-AR	7761-60782	78	780	1.927	380	AR
AT10-800	7761-60800	80	800	1.976	380	Steel	AT10-800-AR	7761-60802	80	800	1.976	380	AR
AT10-840	7761-60840	84	840	2.075	380	Steel	AT10-840-AR	7761-60842	84	840	2.075	380	AR
AT10-890	7761-60890	89	890	2.198	380	Steel	AT10-890-AR	7761-60892	89	890	2.198	380	AR
AT10-920	7761-60920	92	920	2.272	380	Steel	AT10-920-AR	7761-60922	92	920	2.272	380	AR
AT10-960	7761-60960	96	960	2.371	380	Steel	AT10-960-AR	7761-60962	96	960	2.371	380	AR
AT10-980	7761-60980	98	980	2.421	380	Steel	AT10-980-AR	7761-60982	98	980	2.421	380	AR
AT10-1010	7761-61010	101	1010	2.495	380	Steel	AT10-1010-AR	7761-61012	101	1010	2.495	380	AR
AT10-1050	7761-61050	105	1050	2.594	380	Steel	AT10-1050-AR	7761-61052	105	1050	1.72	380	AR
AT10-1080	7761-61080	108	1080	2.668	380	Steel	AT10-1080-AR	7761-61082	108	1080	2.668	380	AR
AT10-1100	7761-61100	110	1100	2.717	380	Steel	AT10-1100-AR	7761-61102	110	1100	2.717	380	AR
AT10-1150	7761-61150	115	1150	2.841	380	Steel	AT10-1150-AR	7761-61152	115	1150	2.841	380	AR
AT10-1200	7761-61200	120	1200	2.964	380	Steel	AT10-1200-AR	7761-61202	120	1200	2.964	380	AR
AT10-1210	7761-61210	121	1210	2.989	380	Steel	AT10-1210-AR	7761-61212	121	1210	2.989	380	AR
AT10-1250	7761-61250	125	1250	3.088	380	Steel	AT10-1250-AR	7761-61252	125	1250	3.088	380	AR
AT10-1280	7761-61280	128	1280	3.162	380	Steel	AT10-1280-AR	7761-61282	128	1280	3.162	380	AR
AT10-1320	7761-61320	132	1320	3.26	380	Steel	AT10-1320-AR	7761-61322	132	1320	3.26	380	AR
AT10-1350	7761-61350	135	1350	3.335	380	Steel	AT10-1350-AR	7761-61352	135	1350	3.335	380	AR
AT10-1360	7761-61360	136	1360	3.359	380	Steel	AT10-1360-AR	7761-61362	136	1360	3.359	380	AR
AT10-1400	7761-61400	140	1400	3.458	380	Steel	AT10-1400-AR	7761-61402	140	1400	3.458	380	AR
AT10-1420	7761-61420	142	1420	3.507	380	Steel	AT10-1420-AR	7761-61422	142	1420	3.507	380	AR
AT10-1480	7761-61480	148	1480	3.656	380	Steel	AT10-1480-AR	7761-61482	148	1480	3.656	380	AR
AT10-1500	7761-61500	150	1500	3.705	380	Steel	AT10-1500-AR	7761-61502	150	1500	3.705	380	AR
AT10-1600	7761-61603	160	1600	2.08	200	Steel	AT10-1600-AR	7761-61602	160	1600	2.08	200	AR
AT10-1700	7761-61703	170	1700	2.21	200	Steel	AT10-1700-AR	7761-61702	170	1700	2.21	200	AR
AT10-1800	7761-61803	180	1800	2.34	200	Steel	AT10-1800-AR	7761-61802	180	1800	2.34	200	AR
AT10-1860	7761-61860	186	1860	2.418	200	Steel	AT10-1860-AR	7761-61862	186	1860	2.418	200	AR
AT10-1940	7761-61940	194	1940	2.522	200	Steel	AT10-1940-AR	7761-61942	194	1940	2.522	200	AR



SYNCHRO-POWER DL-T5-6 BELT

Part Number	Product Number	Number of Teeth	Pitch Length (mm)	Weight [kg]
DL-T5-300-6	7762-80301	60	300	0.005
DL-T5-400-6	7762-80399	80	400	0.006
DL-T5-410-6	7762-80411	82	410	0.006
DL-T5-450-6	7762-80450	90	450	0.007
DL-T5-460-6	7762-80461	92	460	0.007
DL-T5-480-6	7762-80481	96	480	0.007
DL-T5-500-6	7762-80505	100	500	0.008
DL-T5-515-6	7762-80516	103	515	0.008
DL-T5-550-6	7762-80551	110	550	0.009
DL-T5-590-6	7762-80591	118	590	0.009
DL-T5-600-6	7762-80601	120	600	0.009
DL-T5-620-6	7762-80621	124	620	0.01
DL-T5-650-6	7762-80651	130	650	0.01
DL-T5-700-6	7762-80701	140	700	0.011
DL-T5-750-6	7762-80751	150	750	0.012
DL-T5-815-6	7762-80811	163	815	0.013
DL-T5-900-6	7762-80901	180	900	0.014
DL-T5-940-6	7762-80941	188	940	0.015
DL-T5-1100-6	7762-81101	220	1100	0.017

SYNCHRO-POWER DL-T5-8 BELT

Part Number	Product Number	Number of Teeth	Pitch Length (mm)	Weight [kg]
DL-T5-300-8	7762-80302	60	300	0.006
DL-T5-400-8	7762-80401	80	400	0.008
DL-T5-410-8	7762-80412	82	410	0.009
DL-T5-450-8	7762-80451	90	450	0.009
DL-T5-460-8	7762-80462	92	460	0.01
DL-T5-480-8	7762-80482	96	480	0.01
DL-T5-500-8	7762-80506	100	500	0.01
DL-T5-515-8	7762-80517	103	515	0.011
DL-T5-550-8	7762-80552	110	550	0.011
DL-T5-590-8	7762-80592	118	590	0.012
DL-T5-600-8	7762-80602	120	600	0.012
DL-T5-620-8	7762-80622	124	620	0.013
DL-T5-650-8	7762-80652	130	650	0.014
DL-T5-700-8	7762-80702	140	700	0.015
DL-T5-750-8	7762-80752	150	750	0.016
DL-T5-815-8	7762-80812	163	815	0.017
DL-T5-900-8	7762-80902	180	900	0.019
DL-T5-940-8	7762-80942	188	940	0.02
DL-T5-1100-8	7762-81102	220	1100	0.023

SYNCHRO-POWER DL-T5-10 BELT

Part Number	Product Number	Number of Teeth	Pitch Length (mm)	Weight [kg]
DL-T5-300-10	7762-80303	60	300	0.008
DL-T5-400-10	7762-80402	80	400	0.01
DL-T5-410-10	7762-80413	82	410	0.011
DL-T5-450-10	7762-80452	90	450	0.012
DL-T5-460-10	7762-80463	92	460	0.012
DL-T5-480-10	7762-80483	96	480	0.012
DL-T5-500-10	7762-80507	100	500	0.013
DL-T5-515-10	7762-80518	103	515	0.013
DL-T5-550-10	7762-80553	110	550	0.014
DL-T5-590-10	7762-80593	118	590	0.015
DL-T5-600-10	7762-80603	120	600	0.016
DL-T5-620-10	7762-80623	124	620	0.016
DL-T5-650-10	7762-80653	130	650	0.017
DL-T5-700-10	7762-80703	140	700	0.018
DL-T5-750-10	7762-80753	150	750	0.02
DL-T5-815-10	7762-80813	163	815	0.021
DL-T5-900-10	7762-80903	180	900	0.023
DL-T5-940-10	7762-80943	188	940	0.024
DL-T5-1100-10	7762-81103	220	1100	0.029

SYNCHRO-POWER DL-T5-12 BELT

Part Number	Product Number	Number of Teeth	Pitch Length (mm)	Weight [kg]
DL-T5-300-12	7762-80304	60	300	0.009
DL-T5-400-12	7762-80403	80	400	0.012
DL-T5-410-12	7762-80414	82	410	0.013
DL-T5-450-12	7762-80453	90	450	0.014
DL-T5-460-12	7762-80464	92	460	0.014
DL-T5-480-12	7762-80484	96	480	0.015
DL-T5-500-12	7762-80508	100	500	0.016
DL-T5-515-12	7762-80519	103	515	0.016
DL-T5-550-12	7762-80554	110	550	0.017
DL-T5-590-12	7762-80594	118	590	0.018
DL-T5-600-12	7762-80604	120	600	0.019
DL-T5-620-12	7762-80624	124	620	0.019
DL-T5-650-12	7762-80654	130	650	0.02
DL-T5-700-12	7762-80704	140	700	0.022
DL-T5-750-12	7762-80754	150	750	0.023
DL-T5-815-12	7762-80814	163	815	0.025
DL-T5-900-12	7762-80904	180	900	0.028
DL-T5-940-12	7762-80944	188	940	0.029
DL-T5-1100-12	7762-81104	220	1100	0.034



SYNCHRO-POWER DL-T5-16 BELT

Part Number	Product Number	Number of Teeth	Pitch Length (mm)	Weight [kg]
DL-T5-300-16	7762-80305	60	300	0.012
DL-T5-400-16	7762-80404	80	400	0.017
DL-T5-410-16	7762-80415	82	410	0.017
DL-T5-450-16	7762-80454	90	450	0.019
DL-T5-460-16	7762-80465	92	460	0.019
DL-T5-480-16	7762-80485	96	480	0.02
DL-T5-500-16	7762-80509	100	500	0.021
DL-T5-515-16	7762-80520	103	515	0.021
DL-T5-550-16	7762-80555	110	550	0.023
DL-T5-590-16	7762-80595	118	590	0.025
DL-T5-600-16	7762-80605	120	600	0.025
DL-T5-620-16	7762-80625	124	620	0.026
DL-T5-650-16	7762-80655	130	650	0.027
DL-T5-700-16	7762-80705	140	700	0.029
DL-T5-750-16	7762-80755	150	750	0.031
DL-T5-815-16	7762-80815	163	815	0.034
DL-T5-900-16	7762-80905	180	900	0.037
DL-T5-940-16	7762-80945	188	940	0.039
DL-T5-1100-16	7762-81105	220	1100	0.046

SYNCHRO-POWER DL-T5-20 BELT

Part Number	Product Number	Number of Teeth	Pitch Length (mm)	Weight [kg]
DL-T5-300-20	7762-80306	60	300	0.016
DL-T5-400-20	7762-80405	80	400	0.021
DL-T5-410-20	7762-80416	82	410	0.021
DL-T5-450-20	7762-80455	90	450	0.023
DL-T5-460-20	7762-80466	92	460	0.024
DL-T5-480-20	7762-80486	96	480	0.025
DL-T5-500-20	7762-80510	100	500	0.026
DL-T5-515-20	7762-80521	103	515	0.027
DL-T5-550-20	7762-80556	110	550	0.029
DL-T5-590-20	7762-80596	118	590	0.031
DL-T5-600-20	7762-80606	120	600	0.031
DL-T5-620-20	7762-80626	124	620	0.032
DL-T5-650-20	7762-80656	130	650	0.034
DL-T5-700-20	7762-80706	140	700	0.036
DL-T5-750-20	7762-80756	150	750	0.039
DL-T5-815-20	7762-80816	163	815	0.042
DL-T5-900-20	7762-80906	180	900	0.047
DL-T5-940-20	7762-80946	188	940	0.049
DL-T5-1100-20	7762-81106	220	1100	0.057

SYNCHRO-POWER DL-T5-25 BELT

Part Number	Product Number	Number of Teeth	Pitch Length (mm)	Weight [kg]
DL-T5-300-25	7762-80307	60	300	0.02
DL-T5-400-25	7762-80406	80	400	0.026
DL-T5-410-25	7762-80417	82	410	0.027
DL-T5-450-25	7762-80456	90	450	0.029
DL-T5-460-25	7762-80467	92	460	0.03
DL-T5-480-25	7762-80487	96	480	0.031
DL-T5-500-25	7762-80511	100	500	0.033
DL-T5-515-25	7762-80522	103	515	0.033
DL-T5-550-25	7762-80557	110	550	0.036
DL-T5-590-25	7762-80597	118	590	0.038
DL-T5-600-25	7762-80607	120	600	0.039
DL-T5-620-25	7762-80627	124	620	0.04
DL-T5-650-25	7762-80657	130	650	0.042
DL-T5-700-25	7762-80707	140	700	0.046
DL-T5-750-25	7762-80757	150	750	0.049
DL-T5-815-25	7762-80817	163	815	0.053
DL-T5-900-25	7762-80907	180	900	0.059
DL-T5-940-25	7762-80947	188	940	0.061
DL-T5-1100-25	7762-81107	220	1100	0.072

SYNCHRO-POWER DL-T5-32 BELT

Part Number	Product Number	Number of Teeth	Pitch Length (mm)	Weight [kg]
DL-T5-300-32	7762-80308	60	300	0.025
DL-T5-400-32	7762-80407	80	400	0.033
DL-T5-410-32	7762-80418	82	410	0.034
DL-T5-450-32	7762-80457	90	450	0.037
DL-T5-460-32	7762-80468	92	460	0.038
DL-T5-480-32	7762-80488	96	480	0.04
DL-T5-500-32	7762-80512	100	500	0.042
DL-T5-515-32	7762-80523	103	515	0.043
DL-T5-550-32	7762-80558	110	550	0.046
DL-T5-590-32	7762-80598	118	590	0.049
DL-T5-600-32	7762-80608	120	600	0.05
DL-T5-620-32	7762-80628	124	620	0.052
DL-T5-650-32	7762-80658	130	650	0.054
DL-T5-700-32	7762-80708	140	700	0.058
DL-T5-750-32	7762-80758	150	750	0.062
DL-T5-815-32	7762-80818	163	815	0.068
DL-T5-900-32	7762-80908	180	900	0.075
DL-T5-940-32	7762-80948	188	940	0.078
DL-T5-1100-32	7762-81108	220	1100	0.092



SYNCHRO-POWER DL-T5-50 BELT

Part Number	Product Number	Number of Teeth	Pitch Length (mm)	Weight [kg]
DL-T5-300-50	7762-80309	60	300	0.039
DL-T5-400-50	7762-80408	80	400	0.052
DL-T5-410-50	7762-80419	82	410	0.053
DL-T5-450-50	7762-80458	90	450	0.059
DL-T5-460-50	7762-80469	92	460	0.06
DL-T5-480-50	7762-80489	96	480	0.062
DL-T5-500-50	7762-80513	100	500	0.065
DL-T5-515-50	7762-80524	103	515	0.067
DL-T5-550-50	7762-80559	110	550	0.072
DL-T5-590-50	7762-80599	118	590	0.077
DL-T5-600-50	7762-80609	120	600	0.078
DL-T5-620-50	7762-80629	124	620	0.081
DL-T5-650-50	7762-80659	130	650	0.085
DL-T5-700-50	7762-80709	140	700	0.091
DL-T5-750-50	7762-80759	150	750	0.098
DL-T5-815-50	7762-80819	163	815	0.106
DL-T5-900-50	7762-80909	180	900	0.117
DL-T5-940-50	7762-80949	188	940	0.122
DL-T5-1100-50	7762-81109	220	1100	0.143

SYNCHRO-POWER DL-T5-75 BELT

Part Number	Product Number	Number of Teeth	Pitch Length (mm)	Weight [kg]
DL-T5-300-75	7762-80310	60	300	0.059
DL-T5-400-75	7762-80409	80	400	0.078
DL-T5-410-75	7762-80420	82	410	0.08
DL-T5-450-75	7762-80459	90	450	0.088
DL-T5-460-75	7762-80470	92	460	0.09
DL-T5-480-75	7762-80490	96	480	0.094
DL-T5-500-75	7762-80514	100	500	0.098
DL-T5-515-75	7762-80525	103	515	0.1
DL-T5-550-75	7762-80560	110	550	0.107
DL-T5-590-75	7762-80600	118	590	0.002
DL-T5-600-75	7762-80610	120	600	0.117
DL-T5-620-75	7762-80630	124	620	0.121
DL-T5-650-75	7762-80660	130	650	0.127
DL-T5-700-75	7762-80710	140	700	0.137
DL-T5-750-75	7762-80760	150	750	0.146
DL-T5-815-75	7762-80820	163	815	0.159
DL-T5-900-75	7762-80910	180	900	0.176
DL-T5-940-75	7762-80950	188	940	0.183
DL-T5-1100-75	7762-81110	220	1100	0.215

SYNCHRO-POWER DL-T5-SLEEVE

Part Number	Product Number	Number of Teeth	Pitch Length (mm)	Weight [kg]	Sleeve Width [mm]	Cord
DL-T5-300	7761-80300	60	300	0.156	200	Steel
DL-T5-400	7761-80399	80	400	0.395	380	Steel
DL-T5-410	7761-80411	82	410	0.405	380	Steel
DL-T5-450	7761-80449	90	450	0.445	380	Steel
DL-T5-460	7761-80459	92	460	0.454	380	Steel
DL-T5-480	7761-80479	96	480	0.474	380	Steel
DL-T5-500	7761-80499	100	500	0.494	380	Steel
DL-T5-515	7761-80514	103	515	0.509	380	Steel
DL-T5-550	7761-80549	110	550	0.543	380	Steel
DL-T5-590	7761-80589	118	590	0.583	380	Steel
DL-T5-600	7761-80599	120	600	0.593	380	Steel
DL-T5-620	7761-80619	124	620	0.613	380	Steel
DL-T5-650	7761-80649	130	650	0.642	380	Steel
DL-T5-700	7761-80699	140	700	0.692	380	Steel
DL-T5-750	7761-80749	150	750	0.741	380	Steel
DL-T5-815	7761-80814	163	815	0.805	380	Steel
DL-T5-900	7761-80899	180	900	0.889	380	Steel
DL-T5-940	7761-80939	188	940	0.929	380	Steel
DL-T5-1100	7761-81099	220	1100	1.087	380	Steel

Part Number	Product Number	Number of Teeth	Pitch Length (mm)	Weight [kg]	Sleeve Width [mm]	Cord
DL-T5-300-AR	7761-80302	60	300	0.156	200	Aramid
DL-T5-400-AR	7761-80392	80	400	0.395	380	Aramid
DL-T5-410-AR	7761-80412	82	410	0.405	380	Aramid
DL-T5-450-AR	7761-80442	90	450	0.445	380	Aramid
DL-T5-460-AR	7761-80452	92	460	0.454	380	Aramid
DL-T5-480-AR	7761-80472	96	480	0.474	380	Aramid
DL-T5-500-AR	7761-80492	100	500	0.494	380	Aramid
DL-T5-515-AR	7761-80512	103	515	0.509	380	Aramid
DL-T5-550-AR	7761-80542	110	550	0.543	380	Aramid
DL-T5-590-AR	7761-80582	118	590	0.583	380	Aramid
DL-T5-600-AR	7761-80592	120	600	0.593	380	Aramid
DL-T5-620-AR	7761-80612	124	620	0.613	380	Aramid
DL-T5-650-AR	7761-80642	130	650	0.642	380	Aramid
DL-T5-700-AR	7761-80692	140	700	0.692	380	Aramid
DL-T5-750-AR	7761-80742	150	750	0.741	380	Aramid
DL-T5-815-AR	7761-80812	163	815	0.805	380	Aramid
DL-T5-900-AR	7761-80892	180	900	0.889	380	Aramid
DL-T5-940-AR	7761-80932	188	940	0.929	380	Aramid
DL-T5-1100-AR	7761-81092	220	1100	1.087	380	Aramid



SYNCHRO-POWER DL-T10-10 BELT

Part Number	Product Number	Number of Teeth	Pitch Length (mm)	Weight [kg]
DL-T10-600-10	7762-90601	60	600	0.035
DL-T10-630-10	7762-90631	63	630	0.037
DL-T10-660-10	7762-90661	66	660	0.039
DL-T10-700-10	7762-90701	70	700	0.041
DL-T10-750-10	7762-90751	75	750	0.044
DL-T10-800-10	7762-90801	80	800	0.047
DL-T10-840-10	7762-90841	84	840	0.05
DL-T10-900-10	7762-90901	90	900	0.053
DL-T10-980-10	7762-90981	98	980	0.058
DL-T10-1000-10	7762-91001	100	1000	0.059
DL-T10-1100-10	7762-91101	110	1100	0.065
DL-T10-1200-10	7762-91201	120	1200	0.071
DL-T10-1210-10	7762-91211	121	1210	0.071
DL-T10-1300-10	7762-91301	130	1300	0.077
DL-T10-1320-10	7762-91321	132	1320	0.078
DL-T10-1420-10	7762-91421	142	1420	0.084
DL-T10-1600-10	7762-91601	160	1600	0.094
DL-T10-1610-10	7762-91611	161	1610	0.095
DL-T10-1700-10	7762-91701	170	1700	0.1
DL-T10-1880-10	7762-91881	188	1880	0.111

SYNCHRO-POWER DL-T10-12 BELT

Part Number	Product Number	Number of Teeth	Pitch Length (mm)	Weight [kg]
DL-T10-600-12	7762-90602	60	600	0.042
DL-T10-630-12	7762-90632	63	630	0.045
DL-T10-660-12	7762-90662	66	660	0.047
DL-T10-700-12	7762-90702	70	700	0.05
DL-T10-750-12	7762-90752	75	750	0.053
DL-T10-800-12	7762-90802	80	800	0.057
DL-T10-840-12	7762-90842	84	840	0.059
DL-T10-900-12	7762-90902	90	900	0.064
DL-T10-980-12	7762-90982	98	980	0.069
DL-T10-1000-12	7762-91002	100	1000	0.071
DL-T10-1100-12	7762-91102	110	1100	0.078
DL-T10-1200-12	7762-91202	120	1200	0.085
DL-T10-1210-12	7762-91212	121	1210	0.086
DL-T10-1300-12	7762-91302	130	1300	0.092
DL-T10-1320-12	7762-91322	132	1320	0.093
DL-T10-1420-12	7762-91422	142	1420	0.101
DL-T10-1600-12	7762-91602	160	1600	0.113
DL-T10-1610-12	7762-91612	161	1610	0.114
DL-T10-1700-12	7762-91702	170	1700	0.12
DL-T10-1880-12	7762-91882	188	1880	0.133

SYNCHRO-POWER DL-T10-16 BELT

Part Number	Product Number	Number of Teeth	Pitch Length (mm)	Weight [kg]
DL-T10-600-16	7762-90603	60	600	0.057
DL-T10-630-16	7762-90633	63	630	0.059
DL-T10-660-16	7762-90663	66	660	0.062
DL-T10-700-16	7762-90703	70	700	0.066
DL-T10-750-16	7762-90753	75	750	0.071
DL-T10-800-16	7762-90803	80	800	0.076
DL-T10-840-16	7762-90843	84	840	0.079
DL-T10-900-16	7762-90903	90	900	0.085
DL-T10-980-16	7762-90983	98	980	0.093
DL-T10-1000-16	7762-91003	100	1000	0.094
DL-T10-1100-16	7762-91103	110	1100	0.104
DL-T10-1200-16	7762-91203	120	1200	0.113
DL-T10-1210-16	7762-91213	121	1210	0.114
DL-T10-1300-16	7762-91303	130	1300	0.123
DL-T10-1320-16	7762-91323	132	1320	0.125
DL-T10-1420-16	7762-91423	142	1420	0.134
DL-T10-1600-16	7762-91603	160	1600	0.151
DL-T10-1610-16	7762-91613	161	1610	0.152
DL-T10-1700-16	7762-91703	170	1700	0.16
DL-T10-1880-16	7762-91883	188	1880	0.177

SYNCHRO-POWER DL-T10-20 BELT

Part Number	Product Number	Number of Teeth	Pitch Length (mm)	Weight [kg]
DL-T10-600-20	7762-90604	60	600	0.071
DL-T10-630-20	7762-90634	63	630	0.074
DL-T10-660-20	7762-90664	66	660	0.078
DL-T10-700-20	7762-90704	70	700	0.083
DL-T10-750-20	7762-90754	75	750	0.089
DL-T10-800-20	7762-90804	80	800	0.094
DL-T10-840-20	7762-90844	84	840	0.099
DL-T10-900-20	7762-90904	90	900	0.106
DL-T10-980-20	7762-90984	98	980	0.116
DL-T10-1000-20	7762-91004	100	1000	0.118
DL-T10-1100-20	7762-91104	110	1100	0.13
DL-T10-1200-20	7762-91204	120	1200	0.142
DL-T10-1210-20	7762-91214	121	1210	0.143
DL-T10-1300-20	7762-91304	130	1300	0.153
DL-T10-1320-20	7762-91324	132	1320	0.156
DL-T10-1420-20	7762-91424	142	1420	0.168
DL-T10-1600-20	7762-91604	160	1600	0.189
DL-T10-1610-20	7762-91614	161	1610	0.19
DL-T10-1700-20	7762-91704	170	1700	0.201
DL-T10-1880-20	7762-91884	188	1880	0.222



SYNCHRO-POWER DL-T10-25 BELT

Part Number	Product Number	Number of Teeth	Pitch Length (mm)	Weight [kg]
DL-T10-600-25	7762-90605	60	600	0.089
DL-T10-630-25	7762-90635	63	630	0.093
DL-T10-660-25	7762-90665	66	660	0.097
DL-T10-700-25	7762-90705	70	700	0.103
DL-T10-750-25	7762-90755	75	750	0.111
DL-T10-800-25	7762-90805	80	800	0.118
DL-T10-840-25	7762-90845	84	840	0.124
DL-T10-900-25	7762-90905	90	900	0.133
DL-T10-980-25	7762-90985	98	980	0.145
DL-T10-1000-25	7762-91005	100	1000	0.148
DL-T10-1100-25	7762-91105	110	1100	0.162
DL-T10-1200-25	7762-91205	120	1200	0.177
DL-T10-1210-25	7762-91215	121	1210	0.178
DL-T10-1300-25	7762-91305	130	1300	0.192
DL-T10-1320-25	7762-91325	132	1320	0.195
DL-T10-1420-25	7762-91425	142	1420	0.209
DL-T10-1600-25	7762-91605	160	1600	0.236
DL-T10-1610-25	7762-91615	161	1610	0.237
DL-T10-1700-25	7762-91705	170	1700	0.251
DL-T10-1880-25	7762-91885	188	1880	0.277

SYNCHRO-POWER DL-T10-32 BELT

Part Number	Product Number	Number of Teeth	Pitch Length (mm)	Weight [kg]
DL-T10-600-32	7762-90606	60	600	0.113
DL-T10-630-32	7762-90636	63	630	0.119
DL-T10-660-32	7762-90666	66	660	0.125
DL-T10-700-32	7762-90706	70	700	0.132
DL-T10-750-32	7762-90756	75	750	0.142
DL-T10-800-32	7762-90806	80	800	0.151
DL-T10-840-32	7762-90846	84	840	0.159
DL-T10-900-32	7762-90906	90	900	0.17
DL-T10-980-32	7762-90986	98	980	0.185
DL-T10-1000-32	7762-91006	100	1000	0.189
DL-T10-1100-32	7762-91106	110	1100	0.208
DL-T10-1200-32	7762-91206	120	1200	0.227
DL-T10-1210-32	7762-91216	121	1210	0.228
DL-T10-1300-32	7762-91306	130	1300	0.245
DL-T10-1320-32	7762-91326	132	1320	0.249
DL-T10-1420-32	7762-91426	142	1420	0.268
DL-T10-1600-32	7762-91606	160	1600	0.302
DL-T10-1610-32	7762-91616	161	1610	0.304
DL-T10-1700-32	7762-91706	170	1700	0.321
DL-T10-1880-32	7762-91886	188	1880	0.355

SYNCHRO-POWER DL-T10-50 BELT

Part Number	Product Number	Number of Teeth	Pitch Length (mm)	Weight [kg]
DL-T10-600-50	7762-90607	60	600	0.177
DL-T10-630-50	7762-90637	63	630	0.186
DL-T10-660-50	7762-90667	66	660	0.195
DL-T10-700-50	7762-90707	70	700	0.207
DL-T10-750-50	7762-90757	75	750	0.221
DL-T10-800-50	7762-90807	80	800	0.236
DL-T10-840-50	7762-90847	84	840	0.248
DL-T10-900-50	7762-90907	90	900	0.266
DL-T10-980-50	7762-90987	98	980	0.289
DL-T10-1000-50	7762-91007	100	1000	0.295
DL-T10-1100-50	7762-91107	110	1100	0.325
DL-T10-1200-50	7762-91207	120	1200	0.354
DL-T10-1210-50	7762-91217	121	1210	0.357
DL-T10-1300-50	7762-91307	130	1300	0.384
DL-T10-1320-50	7762-91327	132	1320	0.389
DL-T10-1420-50	7762-91427	142	1420	0.419
DL-T10-1600-50	7762-91607	160	1600	0.472
DL-T10-1610-50	7762-91617	161	1610	0.475
DL-T10-1700-50	7762-91707	170	1700	0.502
DL-T10-1880-50	7762-91887	188	1880	0.555



SYNCHRO-POWER DL-T10-SLEEVE

Part Number	Product Number	Number of Teeth	Pitch Length (mm)	Weight [kg]	Sleeve Width [mm]	Cord
DL-T10-600	7761-90599	60	600	1.345	380	Steel
DL-T10-630	7761-90629	63	630	1.412	380	Steel
DL-T10-660	7761-90659	66	660	1.48	380	Steel
DL-T10-700	7761-90699	70	700	1.569	380	Steel
DL-T10-750	7761-90749	75	750	1.682	380	Steel
DL-T10-800	7761-90799	80	800	1.794	380	Steel
DL-T10-840	7761-90839	84	840	1.883	380	Steel
DL-T10-900	7761-90899	90	900	2.018	380	Steel
DL-T10-980	7761-90979	98	980	2.197	380	Steel
DL-T10-1000	7761-90999	100	1000	2.242	380	Steel
DL-T10-1100	7761-91099	110	1100	2.466	380	Steel
DL-T10-1200	7761-91199	120	1200	2.69	380	Steel
DL-T10-1210	7761-91209	121	1210	2.713	380	Steel
DL-T10-1300	7761-91299	130	1300	2.915	380	Steel
DL-T10-1320	7761-91319	132	1320	2.959	380	Steel
DL-T10-1420	7761-91419	142	1420	3.184	380	Steel
DL-T10-1600	7761-91599	160	1600	1.888	200	Steel
DL-T10-1610	7761-91609	161	1610	1.715	200	Steel
DL-T10-1700	7761-91699	170	1700	2.006	200	Steel
DL-T10-1880	7761-91879	188	1880	2.218	200	Steel

Part Number	Product Number	Number of Teeth	Pitch Length (mm)	Weight [kg]	Sleeve Width [mm]	Cord
DL-T10-600-AR	7761-90592	60	600	1.345	380	Aramid
DL-T10-630-AR	7761-90622	63	630	1.412	380	Aramid
DL-T10-660-AR	7761-90652	66	660	1.48	380	Aramid
DL-T10-700-AR	7761-90692	70	700	1.569	380	Aramid
DL-T10-750-AR	7761-90742	75	750	1.682	380	Aramid
DL-T10-800-AR	7761-90792	80	800	1.794	380	Aramid
DL-T10-840-AR	7761-90832	84	840	1.883	380	Aramid
DL-T10-900-AR	7761-90892	90	900	2.018	380	Aramid
DL-T10-980-AR	7761-90972	98	980	2.197	380	Aramid
DL-T10-1000-AR	7761-90992	100	1000	2.242	380	Aramid
DL-T10-1100-AR	7761-91092	110	1100	2.466	380	Aramid
DL-T10-1200-AR	7761-91192	120	1200	1.5	380	Aramid
DL-T10-1210-AR	7761-91202	121	1210	2.713	380	Aramid
DL-T10-1300-AR	7761-91292	130	1300	2.915	380	Aramid
DL-T10-1320-AR	7761-91312	132	1320	2.959	380	Aramid
DL-T10-1420-AR	7761-91412	142	1420	3.184	380	Aramid
DL-T10-1600-AR	7761-91592	160	1600	1.888	200	Aramid
DL-T10-1610-AR	7761-91602	161	1610	1.9	200	Aramid
DL-T10-1700-AR	7761-91692	170	1700	2.006	200	Aramid
DL-T10-1880-AR	7761-91872	188	1880	2.218	200	Aramid



SYNCHRO-POWER LINEAR T PITCHES

WIDTH / NYLON FABRIC	ROLL LENGTH [M]	STEEL CORD				ARAMID CORD			
		NO	NT	NB	NTB	NO	NT	NB	NTB
T5									
10	100	7787-11023	7787-11083		7787-11163	7787-11063	7787-11103		7787-11183
16	100	7787-11025	7787-11085		7787-11165	7787-11065	7787-11105		7787-11185
25	100	7787-11027	7787-11087		7787-11167	7787-11067	7787-11107		7787-11187
32	100	7787-11028	7787-11088		7787-11168	7787-11068	7787-11108		7787-11188
50	100	7787-11029	7787-11089		7787-11169	7787-11069	7787-11109		7787-11189
75	100	7787-11030	7787-11090		7787-11170	7787-11070	7787-11110		7787-11190
100	100	7787-11031	7787-11091		7787-11171	7787-11071	7787-11111		7787-11191
T10									
16	100	7787-12022	7787-12082		7787-12162	7787-12062	7787-12102		7787-12182
25	100	7787-12024	7787-12084		7787-12164	7787-12064	7787-12104		
32	100	7787-12025	7787-12085		7787-12165	7787-12065	7787-12105		7787-12185
40	100		7787-12091		7787-12171	7787-12071	7787-12111		7787-12191
50	100	7787-12026	7787-12086		7787-12166	7787-12066	7787-12106		7787-12186
75	100	7787-12027	7787-12087		7787-12167	7787-12067	7787-12107		7787-12187
100	100	7787-12028	7787-12088	7787-12128	7787-12168	7787-12068	7787-12108		7787-12188
150	100	7787-12030	7787-12090		7787-12170	7787-12070	7787-12110		7787-12190
T10HF									
16	100	7787-12262	7787-12282		7787-12322				
25	100	7787-12264	7787-12284		7787-12324				
32	100	7787-12265	7787-12285		7787-12325				
50	100	7787-12266	7787-12286		7787-12326				
75	100	7787-12267	7787-12287		7787-12327				
100	100	7787-12268	7787-12288		7787-12328				
150	100	7787-12270	7787-12290		7787-12330				
T20									
25	50	7787-13001	7787-13020		7787-13040	7787-13010			
32	50	7787-13002	7787-13021		7787-13041	7787-13011			
50	50	7787-13003	7787-13022		7787-13042	7787-13012			
75	50	7787-13005	7787-13024		7787-13044	7787-13014			
100	50	7787-13006	7787-13025		7787-13045	7787-13015			
150	50	7787-13007	7787-13026		7787-13046	7787-13016			



SYNCHRO-POWER LINEAR AT PITCHES

WIDTH / NYLON FABRIC	ROLL LENGTH [M]	STEEL CORD				ARAMID CORD				STAINLESS STEEL (NIRO)
		NO	NT	NB	NTB	NO	NT	NB	NTB	NO
AT5										
6	100		7787-20081		7787-20141	7787-20061	7787-20101			
10	100	7787-20023	7787-20083		7787-20143	7787-20063	7787-20103			
16	100	7787-20025	7787-20085		7787-20145	7787-20065	7787-20106			
20	100	7787-20026	7787-20086		7787-20146					
25	100	7787-20027	7787-20087		7787-20147	7787-20067	7787-20107			
32	100	7787-20028	7787-20088		7787-20148	7787-20068	7787-20108			
50	100	7787-20029	7787-20089		7787-20149	7787-20069	7787-20109			
75	100	7787-20030	7787-20090		7787-20150	7787-20070	7787-20110			
100	100	7787-20031	7787-20091		7787-20151	7787-20071	7787-20111			
AT10										
16	100	7787-21022	7787-21052		7787-21092	7787-21032	7787-21062		7787-21122	7787-23222
25	100	7787-21024	7787-21054		7787-21094	7787-21034	7787-21064		7787-21124	7787-23224
32	100	7787-21025	7787-21055		7787-21095	7787-21035	7787-21065		7787-21125	7787-23225
50	100	7787-21026	7787-21056		7787-21096	7787-21036	7787-21066		7787-21126	7787-23226
75	100	7787-21027	7787-21057		7787-21097	7787-21037	7787-21067		7787-21127	7787-23227
100	100	7787-21028	7787-21058		7787-21098	7787-21038	7787-21068		7787-21128	7787-23228
150	100	7787-21030	7787-21060		7787-21100	7787-21040	7787-21070		7787-21123	7787-23230
AT20										
25	50	7787-22001	7787-22010		7787-22030					
32	50	7787-22002	7787-22011		7787-22031					
50	50	7787-22003	7787-22012		7787-22032					
75	50	7787-22004	7787-22013		7787-22033					
100	50	7787-22005	7787-22014		7787-22034					
150	50	7787-22006	7787-22015		7787-22035					



SYNCHRO-POWER LINEAR ATL PITCHES

WIDTH / NYLON FABRIC	ROLL LENGTH [M]	STEEL CORD				STEEL HIGH FLEX CORD			
		NO	NT	NB	NTB	NO	NT	NB	NTB
ATL5									
10	100	7787-30022	7787-30042		7787-30082				
16		7787-30024	7787-30044		7787-30084				
25		7787-30026	7787-30046		7787-30086				
32		7787-30027	7787-30047		7787-30087				
50		7787-30028	7787-30048		7787-30088				
ATL10									
16	100	7787-31022	7787-31042	7787-31062	7787-31082	7787-32022	7787-32042	7787-32062	7787-32082
25	100	7787-31024	7787-31044	7787-31064	7787-31084	7787-32024	7787-32044	7787-32064	7787-32084
32	100	7787-31025	7787-31045	7787-31065	7787-31085	7787-32025	7787-32045	7787-32065	7787-32085
50	100	7787-31026	7787-31046	7787-31066	7787-31086	7787-32026	7787-32046	7787-32066	7787-32086
75	100	7787-31027	7787-31047	7787-31067	7787-31087	7787-32027	7787-32047	7787-32067	7787-32087
100	100	7787-31028	7787-31048	7787-31068	7787-31088	7787-32028	7787-32048	7787-32068	7787-32088
150	100	7787-31029	7787-31049		7787-31089	7787-32030	7787-32050		7787-32090
ATL20									
32	50	7787-33002	7787-33011		7787-33031				
50	50	7787-33003	7787-33012		7787-33032				
75	50	7787-33004	7787-33013		7787-33033				
100	50	7787-33005	7787-33014		7787-33034				
150	50	7787-33006	7787-33015		7787-33035				



SYNCHRO-POWER LINEAR HTD PITCHES

WIDTH / NYLON FABRIC	ROLL LENGTH [M]	STEEL CORD				ARAMID CORD				STAINLESS STEEL (NIRO)
		NO	NT	NB	NTB	NO	NT	NB	NTB	NO
HTD5										
10	100	7787-50011	7787-50021	7787-50031	7787-50041	7787-50051	7787-50061	7787-50071	7787-50081	
15	100	7787-50012	7787-50022	7787-50032	7787-50042	7787-50052	7787-50062	7787-50072	7787-50082	
20	100	7787-50013	7787-50023	7787-50033	7787-50043	7787-50053	7787-50063	7787-50073	7787-50083	
25	100	7787-50014	7787-50024	7787-50034	7787-50044	7787-50054	7787-50064	7787-50074	7787-50084	
50	100	7787-50016	7787-50026	7787-50036	7787-50046	7787-50056	7787-50066	7787-50076	7787-50086	
100	100	7787-50018	7787-50028	7787-50038	7787-50048	7787-50058	7787-50068	7787-50078	7787-50088	
150	100	7787-50019	7787-50029	7787-50039	7787-50049	7787-50059	7787-50069	7787-50079	7787-50089	
HTD8										
10	100	7787-51010	7787-51020	7787-51030	7787-51040	7787-51050	7787-51060	7787-51070	7787-51080	7787-51110
15	100	7787-51011	7787-51021	7787-51031	7787-51041	7787-51051	7787-51061	7787-51071	7787-51081	7787-51111
20	100	7787-51012	7787-51022	7787-51032	7787-51042	7787-51052	7787-51062	7787-51072	7787-51082	7787-51112
25	100	7787-51013	7787-51023	7787-51033	7787-51043	7787-51053	7787-51063	7787-51073	7787-51083	7787-51113
30	100	7787-51014	7787-51024	7787-51034	7787-51044	7787-51054	7787-51064	7787-51074	7787-51084	7787-51114
50	100	7787-51015	7787-51025	7787-51035	7787-51045	7787-51055	7787-51065	7787-51075	7787-51085	7787-51115
85	100	7787-51016	7787-51026	7787-51036	7787-51046	7787-51056	7787-51066	7787-51076	7787-51086	7787-51116
100	100	7787-51017	7787-51027	7787-51037	7787-51047	7787-51057	7787-51067	7787-51077	7787-51087	7787-51117
150	100	7787-51018	7787-51028		7787-51048	7787-51058	7787-51068		7787-51088	7787-51118
HTD14										
25	50	7787-52001	7787-52010		7787-52020					
40	50	7787-52002	7787-52011		7787-52021					
55	50	7787-52003	7787-52012		7787-52022					
85	50	7787-52004	7787-52013		7787-52023					
115	50	7787-52005	7787-52014		7787-52024					
170	50	7787-52006	7787-52015		7787-52025					
HTDL14										
55	50	7787-52112	7787-52122		7787-52142					
85	50	7787-52113	7787-52123		7787-52143					
115	50	7787-52114	7787-52124		7787-52144					
170	50	7787-52115	7787-52125		7787-52145					



SYNCHRO-POWER LINEAR GPP PITCHES

WIDTH / NYLON FABRIC	ROLL LENGTH [M]	STEEL CORD			
		NO	NT	NB	NTB
GPP8					
10	100		7787-53101		7787-53120
15	100		7787-53102		7787-53121
20	100		7787-53103		7787-53122
25	100		7787-53104		7787-53123
30	100		7787-53105		7787-53124
50	100		7787-53106		7787-53125
85	100		7787-53107		7787-53126
100	100		7787-53108		7787-53127
150	100		7787-53109		7787-53128
GPP8-RSL					
15	100		7787-53111		7787-53130
20	100		7787-53112		7787-53131
25	100		7787-53113		7787-53132
30	100		7787-53114		7787-53133
50	100		7787-53115		7787-53134
85	100		7787-53116		7787-53135
100	100		7787-53117		7787-53136
150	100		7787-53118		7787-53137
GPP14					
40	50		7787-54101		7787-54114
55	50		7787-54102		7787-54115
85	50		7787-54103		7787-54116
115	50		7787-54104		7787-54117
150	50		7787-54105		7787-54118
170	50		7787-54106		7787-54119
GPP14-RSL					
40	50		7787-54107		7787-54120
55	50		7787-54108		7787-54121
85	50		7787-54109		7787-54122
115	50		7787-54110		7787-54123
150	50		7787-54111		7787-54124
200	50		7787-54112		7787-54125



SYNCHRO-POWER LINEAR STD PITCHES

WIDTH / NYLON FABRIC	ROLL LENGTH [M]	STEEL CORD			
		NO	NT	NB	NTB
STD5					
10	100	7787-60011	7787-60021	7787-60031	7787-60041
15	100	7787-60012	7787-60022	7787-60032	7787-60042
20	100	7787-60013	7787-60023	7787-60033	7787-60043
25	100	7787-60014	7787-60024	7787-60034	7787-60044
30	100	7787-60015	7787-60025	7787-60035	7787-60045
50	100	7787-60016	7787-60026	7787-60036	7787-60046
STD8					
10	100	7787-61010	7787-61020	7787-61030	7787-61040
15	100	7787-61011	7787-61021	7787-61031	7787-61041
20	100	7787-61012	7787-61022	7787-61032	7787-61042
25	100	7787-61013	7787-61023	7787-61033	7787-61043
30	100	7787-61014	7787-61024	7787-61034	7787-61044
50	100	7787-61015	7787-61025	7787-61035	7787-61045
85	100	7787-61016	7787-61026	7787-61036	7787-61046
100	100	7787-61017	7787-61027	7787-61037	7787-61047



SYNCHRO-POWER LINEAR IMPERIAL PITCHES

WIDTH / NYLON FABRIC	ROLL LENGTH [M]	STEEL CORD				ARAMID CORD			
		NO	NT	NB	NTB	NO	NT	NB	NTB
XL									
9.4	100	7787-70003				7787-70012			
25.4	100	7787-70006							
50.8	100	7787-70007							
L									
12.7	100	7787-71002							
19.1	100	7787-71003							
25.4	100	7787-71004							
38.1	100	7787-71005							
50.8	100	7787-71006							
H									
12.7	100	7787-72002	7787-72030		7787-72070	7787-72021	7787-72040		7787-72080
19.1	100	7787-72003	7787-72031		7787-72071	7787-72022	7787-72041		
25.4	100	7787-72004	7787-72032		7787-72072	7787-72023	7787-72042		7787-72082
38.1	100	7787-72005	7787-72033		7787-72073	7787-72024	7787-72043		7787-72083
50.8	100	7787-72006	7787-72034		7787-72074	7787-72025	7787-72044		7787-72084
76.2	100	7787-72007	7787-72035		7787-72075	7787-72026	7787-72045		7787-72085
101.6	100	7787-72008	7787-72036		7787-72076	7787-72027	7787-72046		7787-72086
152.4	100	7787-72010	7787-72038		7787-72078	7787-72029	7787-72048		7787-72088
XH									
25.4	50	7787-74001	7787-74010		7787-74030				
38.1	50	7787-74002	7787-74012		7787-74032				
50.8	50		7787-74011		7787-74031				
76.2	50	7787-74004	7787-74013		7787-74033				
101.6	50	7787-74005	7787-74014		7787-74034				
152.4	50	7787-74006	7787-74015		7787-74035				



8. SUPPORT SERVICES



GATES. DRIVEN BY POSSIBILITY.

Every day, design engineers, maintenance people, equipment manufacturers and their customers around the world rely on Gates to keep them running smoothly, safely and reliably. Whether driven by people, equipment or technology, Gates provides a wide range of services to optimize belt drive performance and deliver the best value to customers in return for their investment in Gates' products.

DESIGN POWER: GATES DRIVE DESIGN SOFTWARE

Gates Design Power is the home for all Gates power transmission digital design tools (for PC and mobile phone), including substantially upgraded versions of our well-known Design IQ™ and Design Flex Pro™ applications.

The mobile version of Gates Design Power provides digital tools to support belt drive system engineering in the palm of their hands. Both Gates Design Power applications are available globally as free downloads in 15 different languages.

DOWNLOAD GATES BELT DRIVE DESIGN SOFTWARE:

DESIGN POWER
FROM THE GATES.COM WEBSITE



GATES DESIGN POWER
FOR MOBILE APP FOR:

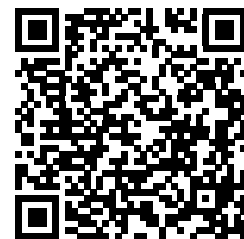



GATES COST SAVING PROGRAMME

Gates' technical and commercial teams are available to perform plant surveys on customers' premises: Gates' distributors and application engineers conduct performance evaluations and develop a maintenance recommendation plan for energy cost savings. They evaluate current belt drive efficiencies using Design Power and the Gates Cost Saving Calculation Tool to develop a preventive maintenance programme maximizing the life of all belt drives in your facility. The energy saving calculations are based on the best information available and represent the typical saving that can be expected from correctly installed drive systems.

GATES E-COMMERCE WEBSITE

An urgent order? A tight delivery deadline? We know that time is crucial for your business. That's why we offer you a way to speed up your order processes with WWW.GATES-ONLINE.COM. Skip additional steps with the Gates e-commerce tool and create short and easily manageable processes for your team.

GATES LITERATURE AND WEBSITE

Please consult our website at www.Gates.com for specific and updated information on all Gates industrial belt products and our list of available literature. Industrial Power Transmission brochures and leaflets can be downloaded there. Distributors may link up with the Gates European site to supply visitors with updated information on the European Gates organization.

GATES MANUFACTURING AND DISTRIBUTION IN EUROPE

Gates Power Transmission Industrial has product dedicated production sites in Germany, Poland, Scotland, France and Spain. Distribution is handled from one central warehouse in Legnica (Poland).

Every effort has been made to ensure the accuracy and comprehensiveness of the information given in this catalogue. However, Gates cannot be held responsible if its products are used in special or exceptional circumstances without prior consultation with and clearance from a Gates representative.

This issue is released in 2024 and supersedes all previous versions of this catalogue. If your catalogue is more than 2 years old, please consult a Gates representative to check whether you have the latest version.

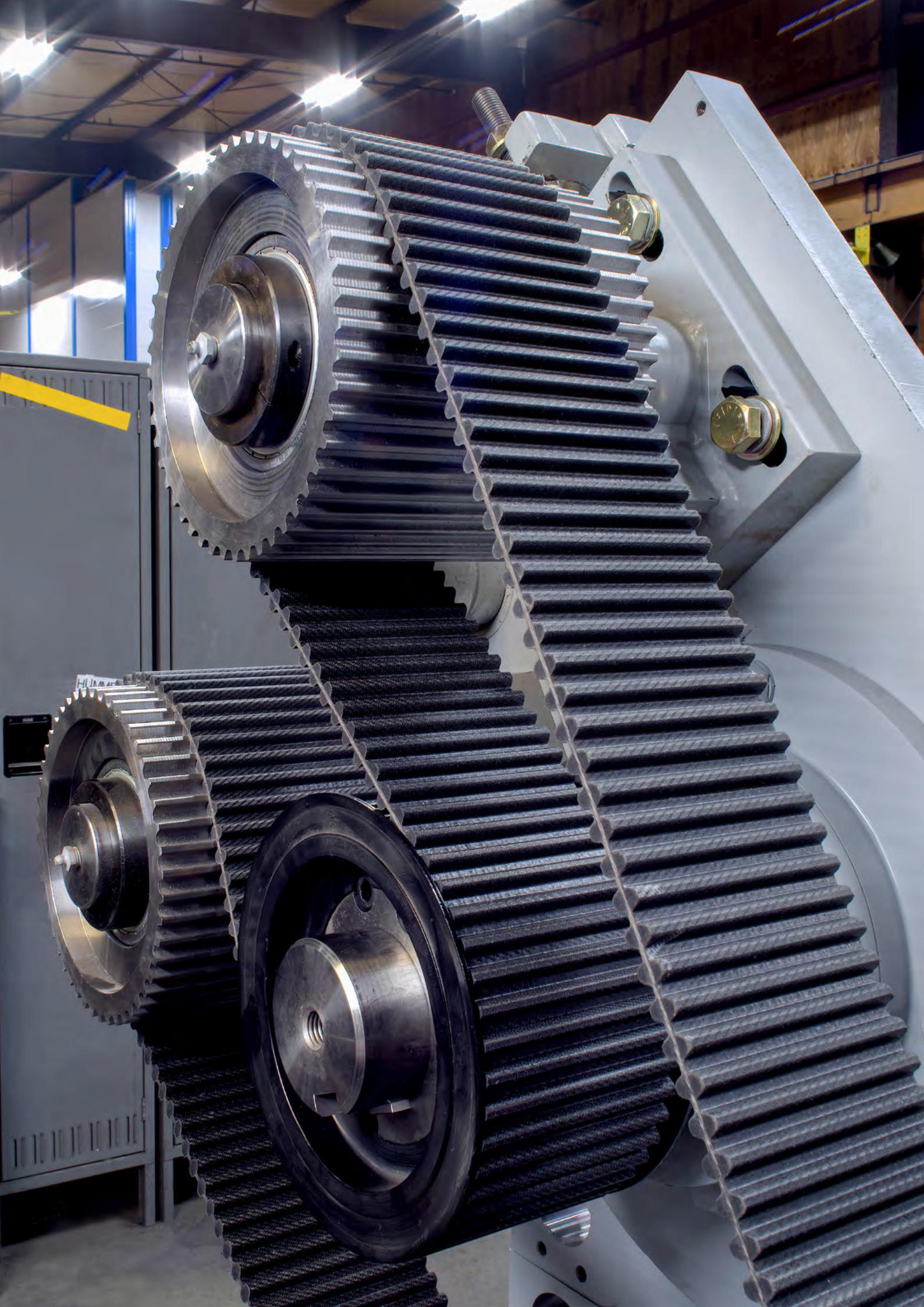



DRIVEN BY POSSIBILITY™

CUSTOMER EXPERIENCE TEAM

VIA PHONE:

+48718814502 FOR POLISH
+48718814503 FOR ENGLISH
+48718814504 FOR FRENCH
+48718814505 FOR GERMAN
+48718814506 FOR ITALIAN
+48718814507 FOR SPANISH

OR VIA E-MAIL:

GATESCSIR@GATES.COM (GATES EUROPE CUSTOMER EXPERIENCE IR)